

LIEBHERR

Use and Care Manual

For Refrigerators

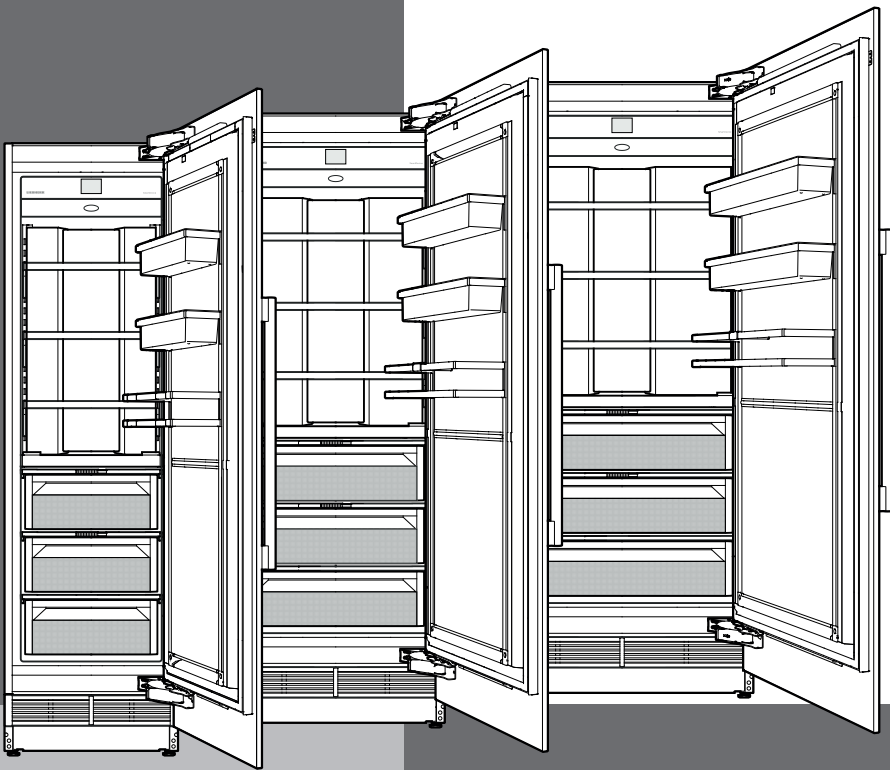

MRB 2400 / MRB 3000 / MRB 3600
7085 975-00

TABLE OF CONTENTS

Table of Contents	Page
Please Read and Follow these Instructions	2
California Proposition 65.....	3
Disposal of Old Appliance	3
Disposal of this Appliance	3
Disposal of Packaging Material	3
Symbols on the device:.....	3
Important Safety Information	4
R600a Refrigerant.....	4
Electrical Safety	5
Safety Regulations.....	5
Description of the Appliance.....	6
Control Panel	7
Switching the Appliance On.....	7
Changing Language and Temperature Unit	7
Main Menu	8
Setting the Refrigerator Compartment Temperature.....	8
Changing the BioFresh-Plus Compartment Temperature	9
SuperCool	9
PartyMode.....	10
HolidayMode.....	10
SabbathMode	11
Switching the Appliance Off	11
Maintenance Message	12
Maintenance Confirmation.....	12
Setup Menu.....	13
SmartDeviceBox (Not Supplied in All Countries)	15
Description of the SmartDevice Displays	16
Alarm Messages	16
Interior Light	17
Equipment.....	17
Water Dispenser	18
BioFresh Compartment	18
BioFresh-Plus Compartment	19
Cleaning	19
Maintenance Menu	21
Maintenance	22
Additional Functions	25
Troubleshooting	29
Customer Service	29
Appliance Information	29

IMPORTANT

All types and models are subject to continuous improvement. The manufacturer reserves the right to make modifications to the shape, equipment and technology.

Please Read and Follow these Instructions

These instructions contain Danger, Warning and Caution notes.

This information is important for safe and efficient installation and operation.

Always read and comply with all Danger, Warning and Caution notes!

DANGER!

Danger indicates a hazard which will cause serious injury or death if precautions are not followed.

WARNING!

Warning indicates a potentially hazardous situation which, if not avoided, could result in death or serious injury.

CAUTION!

Caution indicates a potentially hazardous situation which, if not avoided, may result in minor or moderate injury.

IMPORTANT

This indicates information that is especially relevant to a problem-free installation and operation.

California Proposition 65

- This product contains chemicals known to the state of California to cause cancer or reproductive harm.
- This product can expose you to chemicals including Diisononyl Phthalate (DINP) which is known to the State of California to cause cancer. For more information go to www.P65Warnings.ca.gov.
- This product can expose you to chemicals including Diisodecyl Phthalate (DIDP) which is known to the State of California to cause birth defects or other reproductive harm. For more information go to www.P65Warnings.ca.gov.

Disposal of Old Appliance



Risk of child entrapment.

Child entrapment and suffocation are not problems of the past.

Junked or abandoned refrigerators are still dangerous – even if they will sit for “just a few days.”

If you are getting rid of your old refrigerator, please follow these instructions to help prevent accidents.

Before you discard old appliances:

- **Take off the doors.**
- **Leave the shelves in place so that children may not easily climb inside.**
- **Cut off the power cable from the discarded appliance. Discard separately from the appliance.**
- **Be sure to follow your local requirements for disposal of appliances.**

Contact the trash collection agency in your area for additional information.

Disposal of this Appliance

This appliance contains flammable gases within the refrigeration circuit and insulation foam.

Contact the municipality or disposal company in your area for information on approved recycling or disposal.

Disposal of Packaging Material

The packaging is designed to protect the appliance and individual components during transport and is made of recyclable materials.



Keep packaging materials away from children. Polythene sheets and bags can cause suffocation!

If possible, please recycle packaging material at a recycling facility.

Symbols on the device:

	<p>The symbol can be on the compressor. It refers to the oil in the compressor and refers to the following danger: Can be lethal if swallowed or inhaled. This notice only applies for recycling. There is no danger during normal operation.</p>
	<p>The symbol is located on the compressor and indicates the danger of inflammable materials. Do not remove the label.</p>
	<p>This label or a similar one may be located on the rear of the appliance. This label indicates that there are vacuum insulation panels (VIP) or perlite panels in the door and/or housing. This notice only applies for recycling. Do not remove the label.</p>

Important Safety Information

- Disconnect the appliance from the power source if a fault occurs. Pull out the plug, turn off or disable the power source.
- When disconnecting the appliance, always pull it out by the plug; never pull on the cable.
- Any repairs and work on the appliance should only be performed by the customer service department. Unauthorized work may be dangerous to the user. The power source cable should only be changed or replaced by the customer service department.
- Do not consume food which has been stored for too long; it could cause food poisoning.
- Do not store explosive substances such as aerosol cans with a flammable propellant in this appliance. Electrical components might cause leaking gas to ignite. You can identify such sprays by the printed contents or a flame symbol.
- Do not allow children to play with the appliance. Children must not climb, sit or stand on the shelves, drawers or door.
- To prevent possible injury due to an electrical shock, be sure to disconnect the power cord or turn off the circuit breaker before cleaning the appliance.
- To avoid injury or damage to the appliance, do not use steam cleaning equipment to clean the appliance.
- Do not operate the appliance in the presence of explosive fumes.
- In the event of a power outage, open the door as infrequently as possible.
- This appliance is not intended for use by persons (including children) with reduced

physical, sensory or mental capabilities or lack of experience and knowledge unless they have been given initial supervision or instruction concerning use of the appliance by a person responsible for their safety. Children should be supervised to ensure that they do not play with the appliance.

R600a Refrigerant



The refrigerant R600a contained within the appliance is environmentally friendly, but flammable. Leaking refrigerant can ignite.

To prevent possible ignition, follow the warnings below:

- **Keep ventilation openings, in the appliance enclosure or in the built-in structure, clear of obstruction.** 
- **Do not use mechanical devices or other means to accelerate the defrosting process, other than those recommended by the manufacturer.**
- **Do not damage the refrigerant circuit.**
- **Component parts and power cords shall be replaced with like components performed by factory authorized service personnel only.**
- **Do not use electrical appliances inside the food storage compartments of the appliance, unless they are of the type recommended by the manufacturer.**

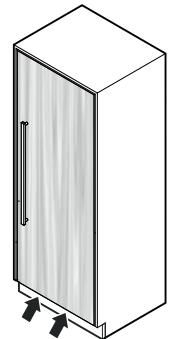

Electrical Safety

Connect this appliance to a 15 amp or 20 amp, 110-120 VAC, circuit which is grounded and protected by a circuit breaker or fuse.

We recommend using a dedicated circuit for this appliance to prevent circuit overload and the chance of interruption to the appliance.

This appliance is equipped with a three-prong (grounding) polarized plug for your protection against possible shock hazards.

Where a two-prong wall receptacle is encountered, contact a qualified electrician and have it replaced with a properly grounded three-prong receptacle in accordance with all local codes and ordinances.



WARNING!

Electrocution hazard.

Electrical grounding required.

- Do not remove the round grounding prong from the plug. →
- Do not use extension cords or ungrounded (two prong) adapters.
- Do not use a power cord that is frayed or damaged.

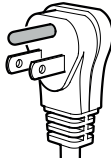

- Do not use a power strip. →

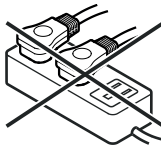

Failure to follow these instructions may result in fire, electrical shock or death.

Safety Regulations

This appliance is intended to be used in household and similar applications.

This includes, for example, use

- in staff kitchenettes, bed and breakfast establishments,
- by guests in cottages, hotels, motels and other forms of accommodation,
- in catering and similar services in the wholesale trade.

IMPORTANT

The appliance is not intended for outdoor use.

The appliance is manufactured to operate within specific ambient temperature limits according to its climate rating.

The climate rating indicates the ambient temperature at which the appliance may be operated in order to achieve full refrigeration performance.

Climate Rating

SN-T

Ambient Temperature

50°F to 109°F (10°C to 43°C)

IMPORTANT

Do not operate the appliance outside the specified ambient temperature range.

- The refrigerant circuit has been tested for leaks.
- The appliance complies with current safety regulations

CAN/CSA C22.2 No.60335-1-11

UL 60335-1 Fifth Edition

CAN/CSA C22.2 No. 60335-2-24:17

UL 60335-2-24 Ed.2

We recommend cleaning the appliance before turning it on for the first time. See **Cleaning**.

Turn on the appliance several hours before loading it.



WARNING!

Do not allow children to play with the appliance. Children must not climb, sit or stand on the racks or door.

Failure to follow these instructions may result in death or serious injury.

Description of the Appliance

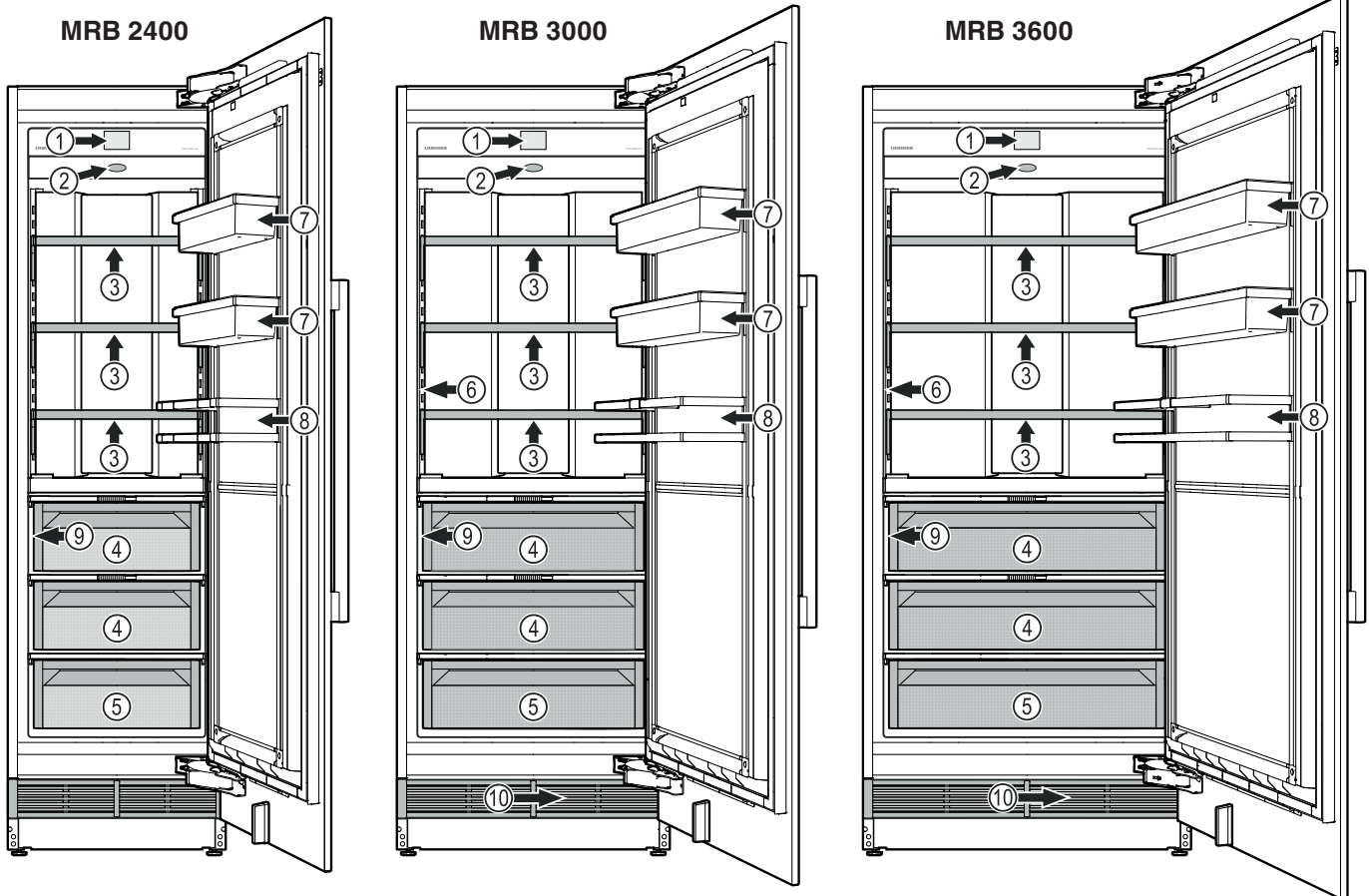
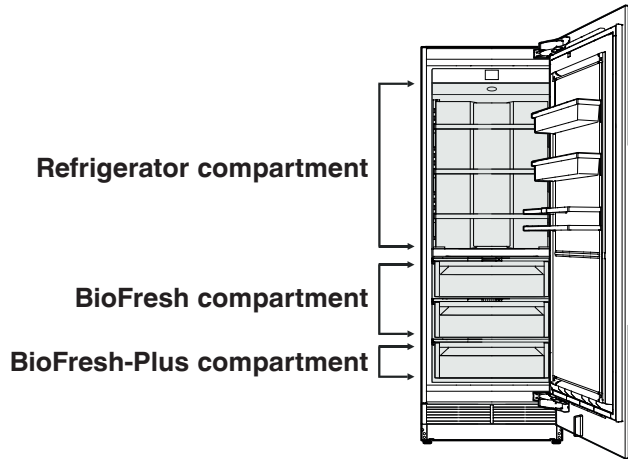

- (1) Control panel
- (2) Air filter
- (3) Adjustable shelves (max. 44 lbs (20 kg))
- (4) BioFresh drawers. Temperature approx. 32°F. For storing dry or wrapped food at low humidity setting, for storing unwrapped food with a high moisture content at high humidity setting.
- (5) BioFresh-Plus drawer. For storing dry or wrapped food at 32°F, for seafood at 28°F.
- (6) Water dispenser
- (7) Adjustable door rack
 - MRB 24.. (max. 44 lbs (20 kg))
 - MRB 30.. (max. 55 lbs (25 kg))
 - MRB 36.. (max. 66 lbs (30 kg))
- (8) Gallon rack
- (9) Model plate (behind the drawer on the left-hand side)
- (10) Water filter (behind the ventilation grille)

Control Panel

Three different actions to operate the control panel.

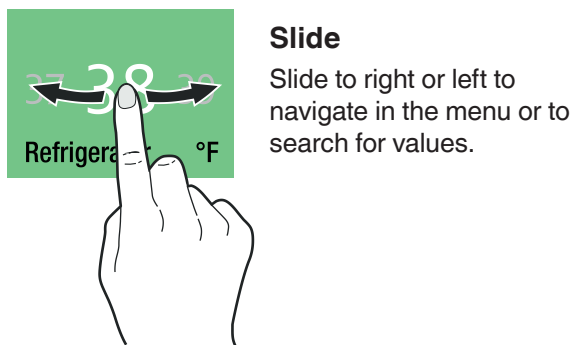
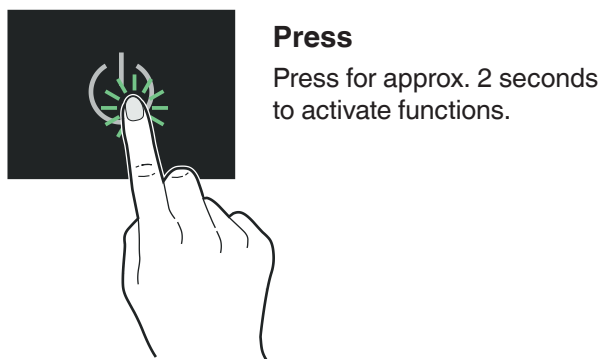
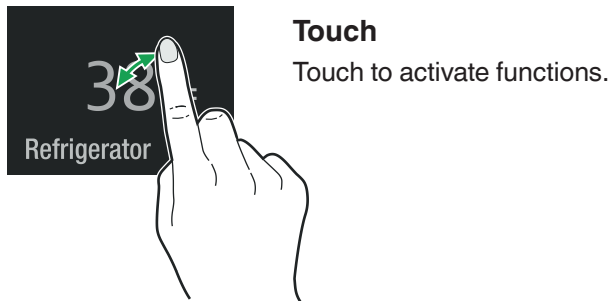

Switching the Appliance On

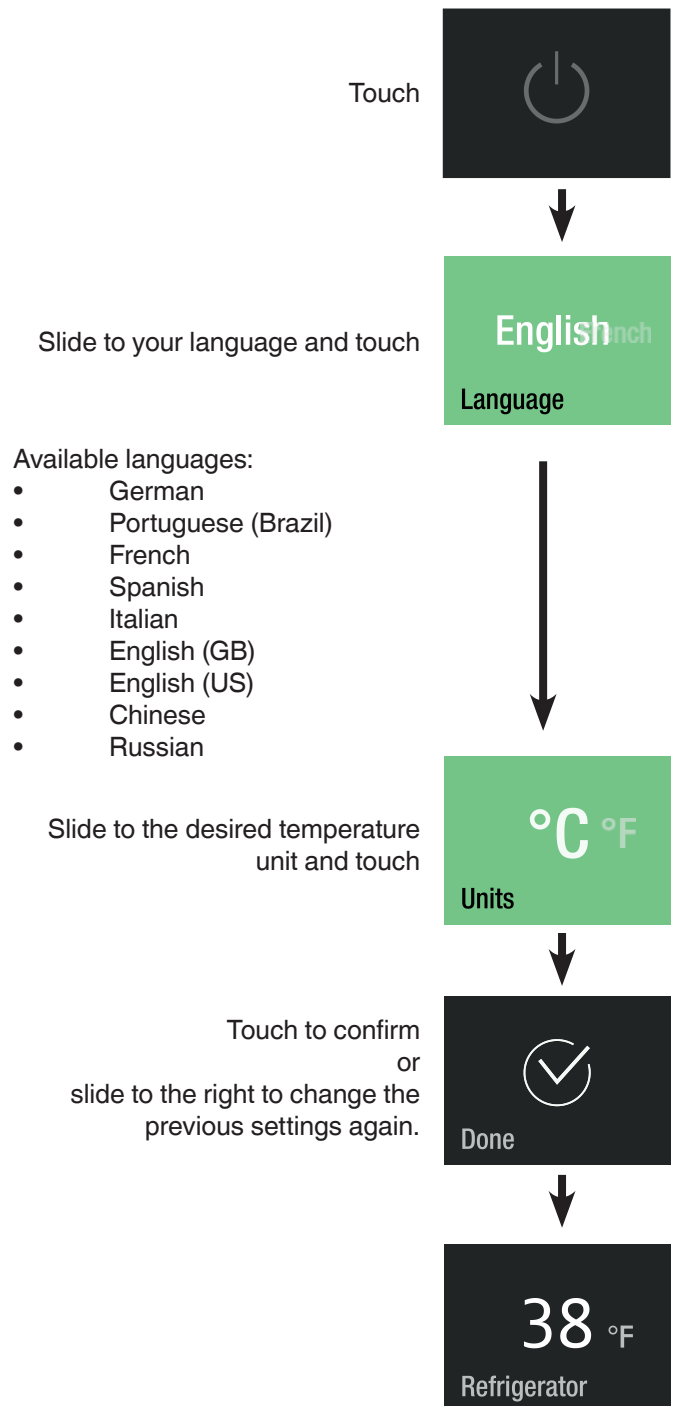







Changing Language and Temperature Unit

For future changes of language and temperature unit the appliance must be switched off and on again (customer settings will not be deleted).

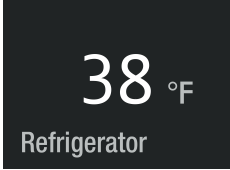
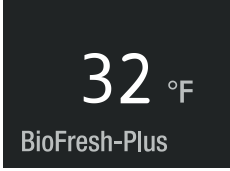
OPERATION

Main Menu

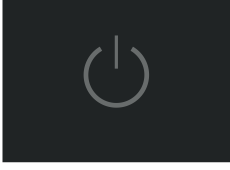
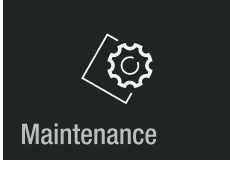
Slide through the main menu. The following functions are available.

 <p>38 °F Refrigerator</p>	Refrigerator compartment temperature display and temperature setting.
 <p>32 °F BioFresh-Plus</p>	BioFresh-Plus compartment temperature display and temperature setting.
 <p>SuperCool</p>	For maximum cooling with time limit and automatic return to normal operating mode.
 <p>PartyMode</p>	For permanent maximum cooling.
 <p>HolidayMode</p>	Switches the appliance to an energy-saving operating mode; the temperature in the refrigerator compartment is increased to 59°F.
 <p>SabbathMode</p>	Appliance operating mode for Sabbath and holidays. Complies with STAR-K Kosher Certification.
 <p>Power</p>	Switching the appliance on or off.
 <p>Maintenance</p>	Describes how to change the filters and clean the water dispenser and dust filter.
 <p>Setup</p>	Allows the adjustment of display brightness and includes the appliance information (service number, model name, serial number).

Setting the Refrigerator Compartment Temperature

Standard setting is 38°F.

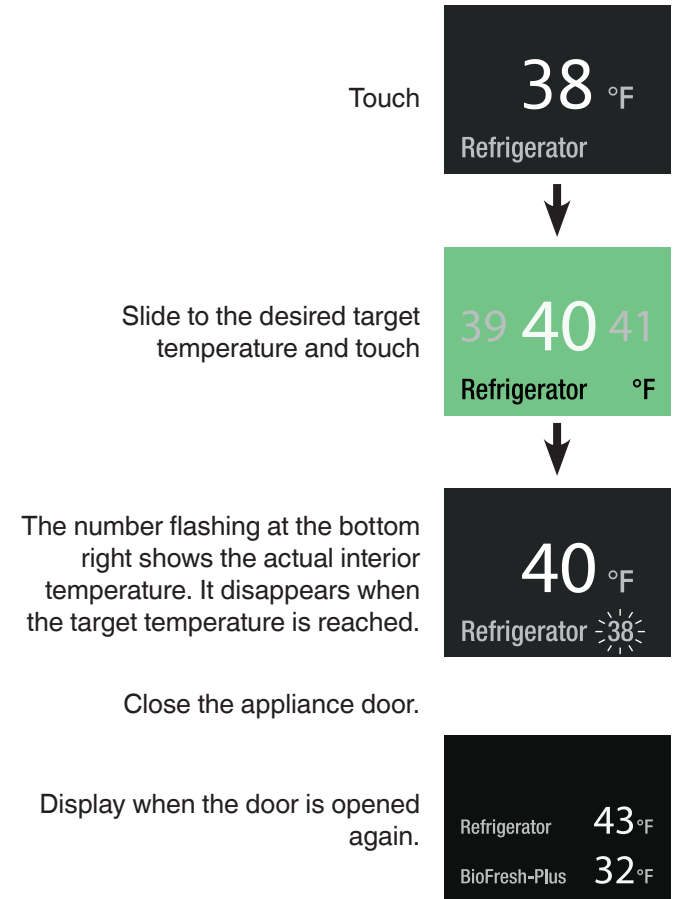

Touch

Slide to the desired target temperature and touch

The number flashing at the bottom right shows the actual interior temperature. It disappears when the target temperature is reached.

Close the appliance door.

Display when the door is opened again.

The refrigerator temperature display flashes if the actual refrigerator temperature is different to the target temperature. It stops flashing when the target temperature is reached.

The temperature can be set at between 36°F and 45°F (2°C and 7°C).

Changing the BioFresh-Plus Compartment Temperature

Standard setting is 32°F.



SuperCool

Activate SuperCool if you wish to cool large quantities of food rapidly. The set temperature is 36°F.

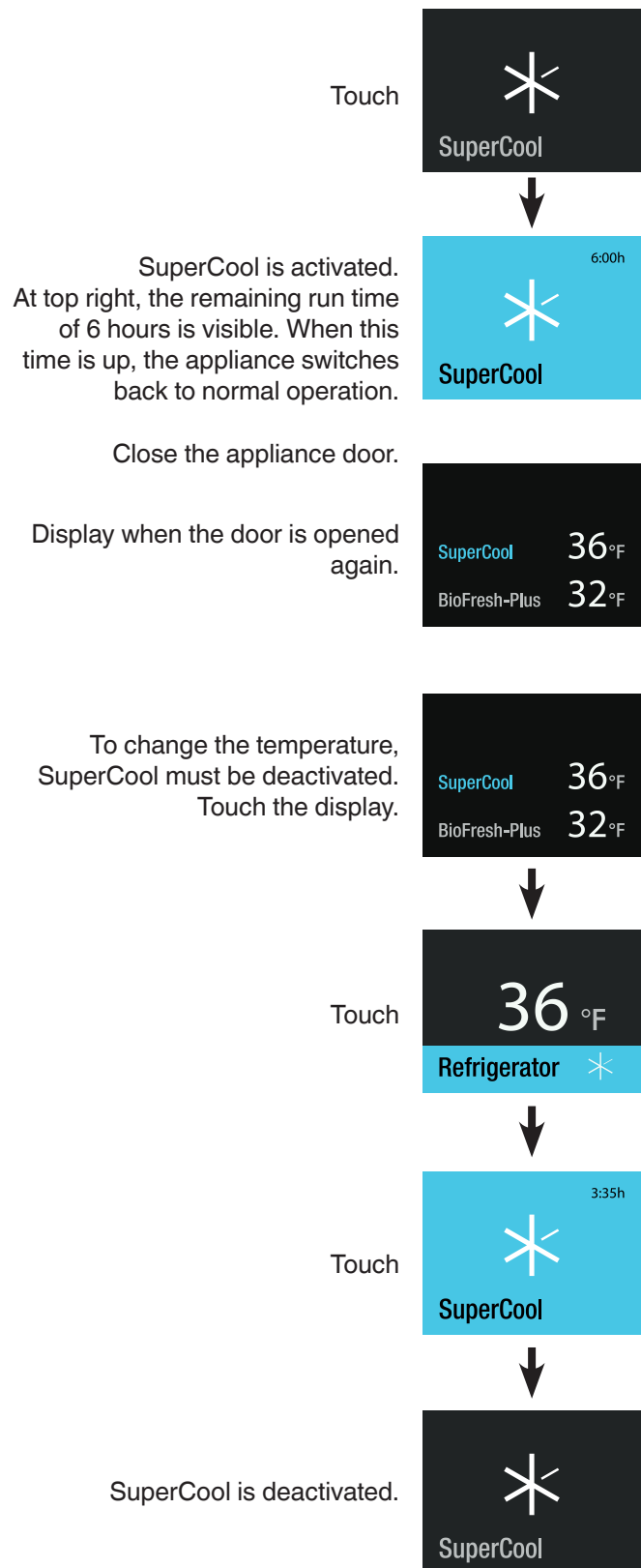

PartyMode

When a large amount of cold food or beverages is needed: Place all the food and beverages in the appliance one day before and activate PartyMode.

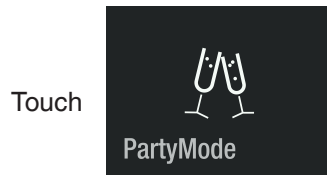

PartyMode is activated.
It must be deactivated manually.
Close the appliance door.



Display when the door is opened again. Refrigerator temperature display flashes.

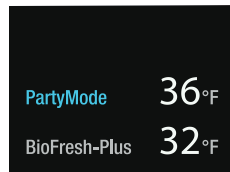

To change the temperature, PartyMode must be deactivated.
Touch the display.

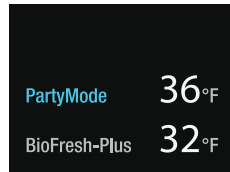

Refer to chapter
**Setting the Refrigerator
Compartment Temperature.**



HolidayMode

In the case of lengthy periods of absence, use up any food which is in the refrigerator and activate HolidayMode. This ensures that no unpleasant odors develop inside the appliance, even if the appliance door is closed. (The temperature in the refrigerator compartment is increased to 59°F.)



HolidayMode is activated.
Close the appliance door.



Display when the door is opened again. The display shows the actual temperature in the refrigerator compartment.

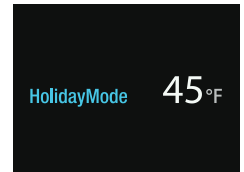

If you want to deactivate HolidayMode, touch the display.

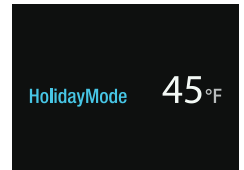

HolidayMode is deactivated.

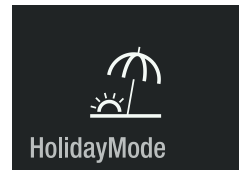

SabbathMode

When SabbathMode is active, some functions of the electronic features are switched off to comply with STAR-K Kosher Certification.

- The lighting remains off.
- The cooling fan remains in its actual state: If it is on, it remains on, if it is off, it remains off.
- There is no door alarm.
- There is no temperature alarm.
- Defrost cycles are independent of the number of times and length of door openings.
- The unit will return to SabbathMode after a power failure.

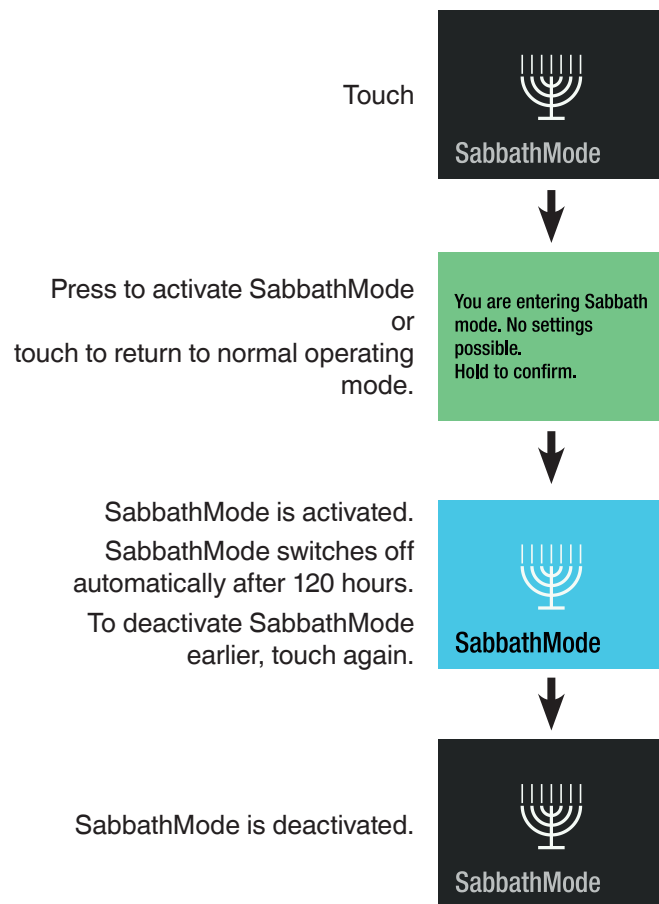

Switching the Appliance Off

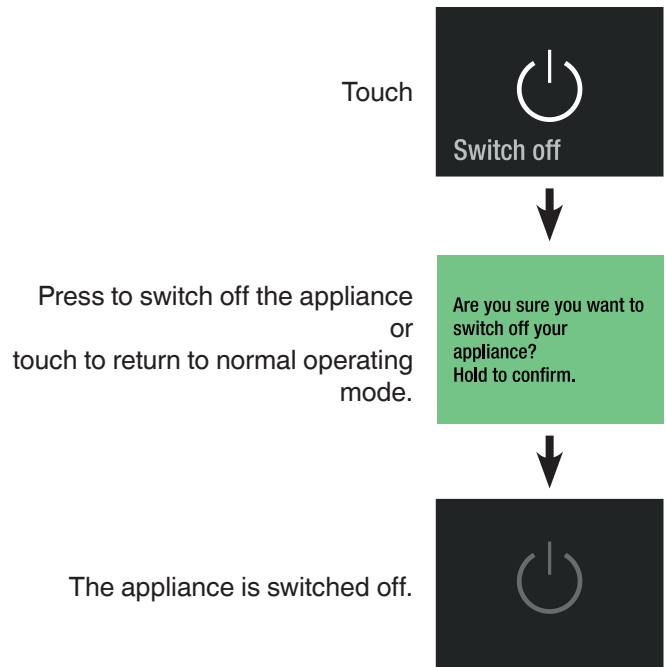

Maintenance Message

In regular intervals of operation of the appliance, the maintenance message comes on (6 months). Filters need to be changed. The water dispenser (if existing) needs to be flushed. The dust filter needs to be cleaned.

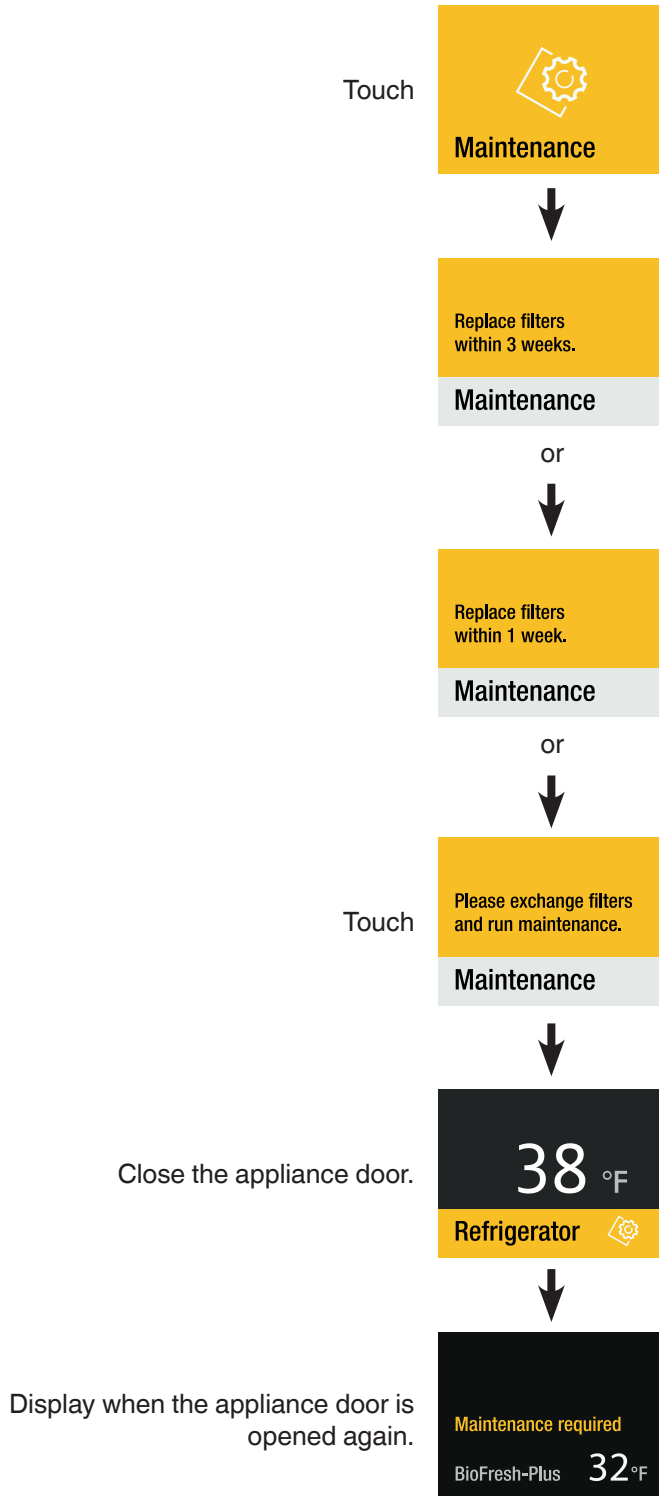

Obtain water filter and air filter from your dealer and complete the maintenance procedure.

Maintenance Confirmation

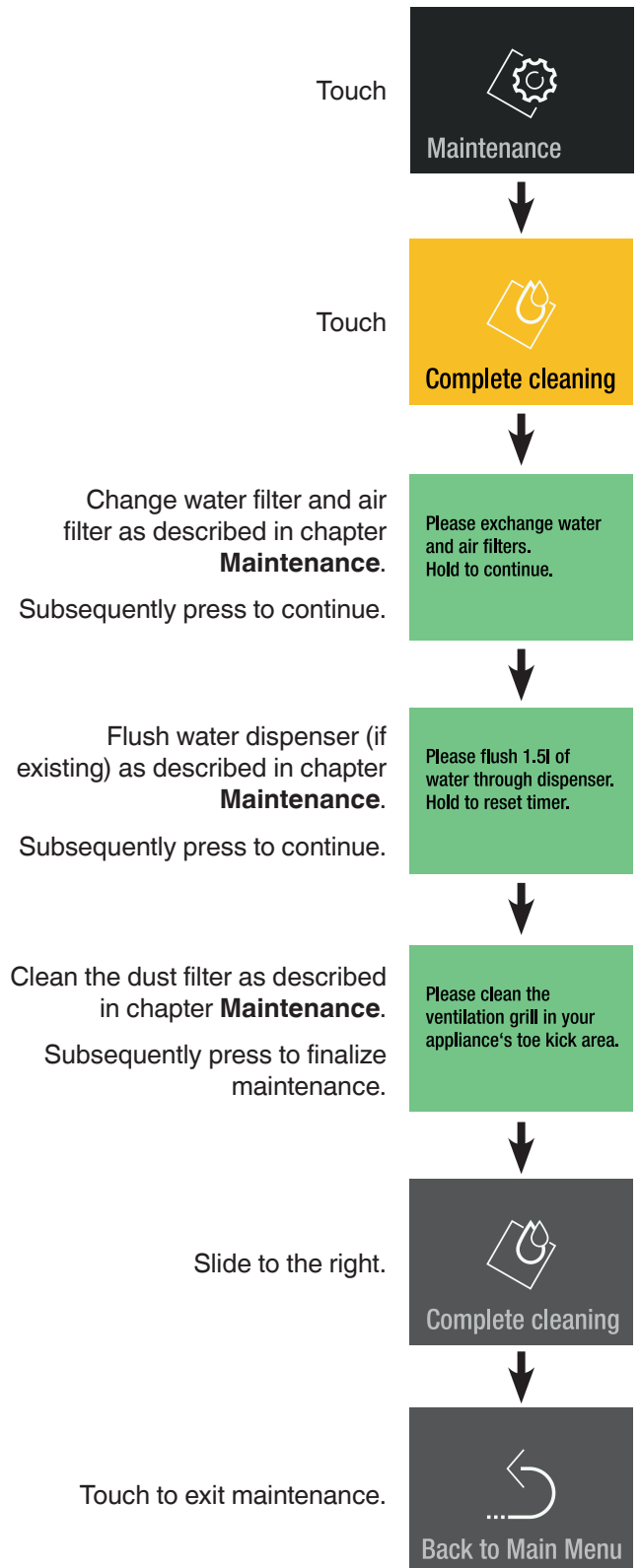

Setup Menu

Includes the adjustment for display brightness, language, units, activation of the SmartDeviceBox and the device information.

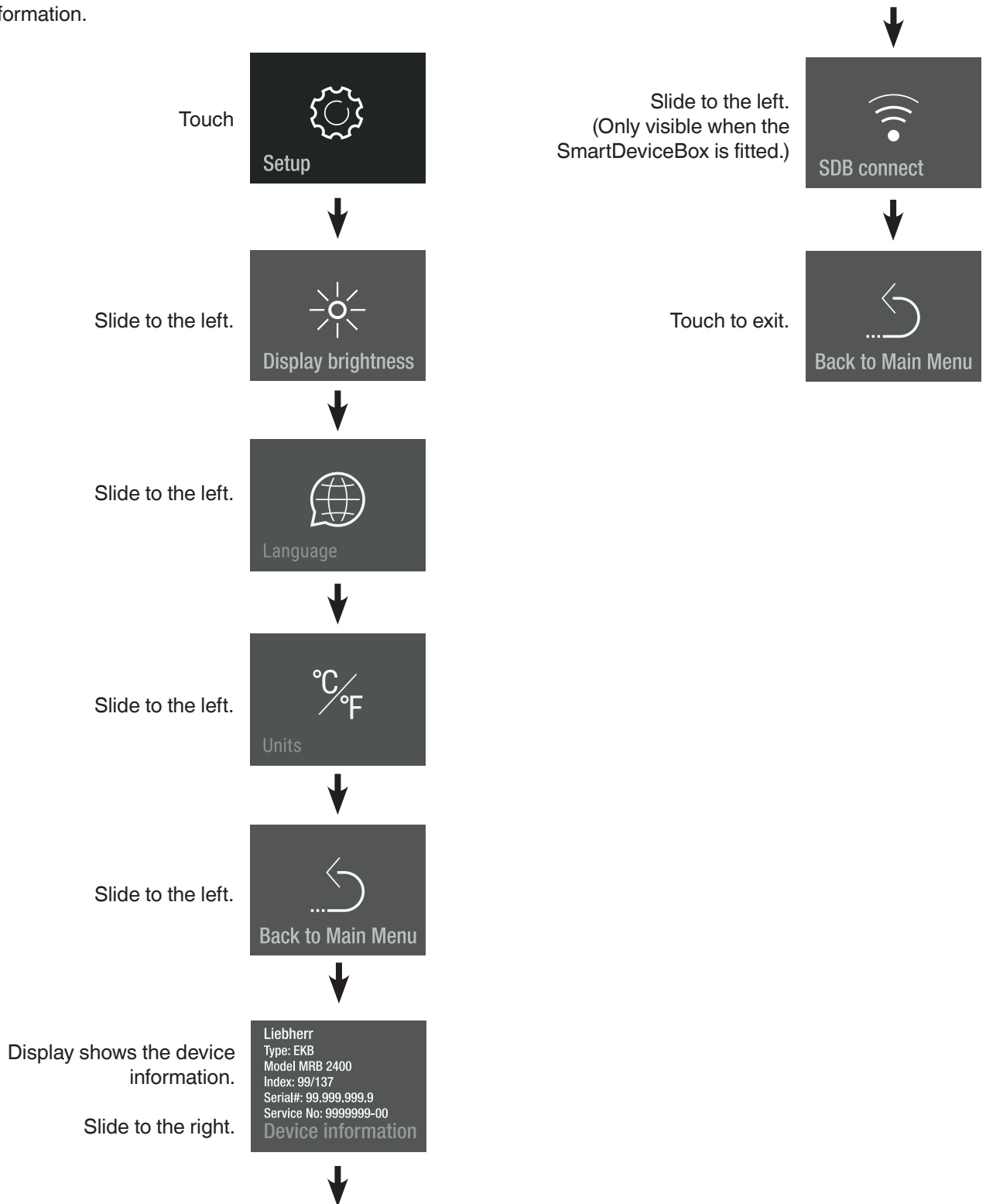

Display Brightness

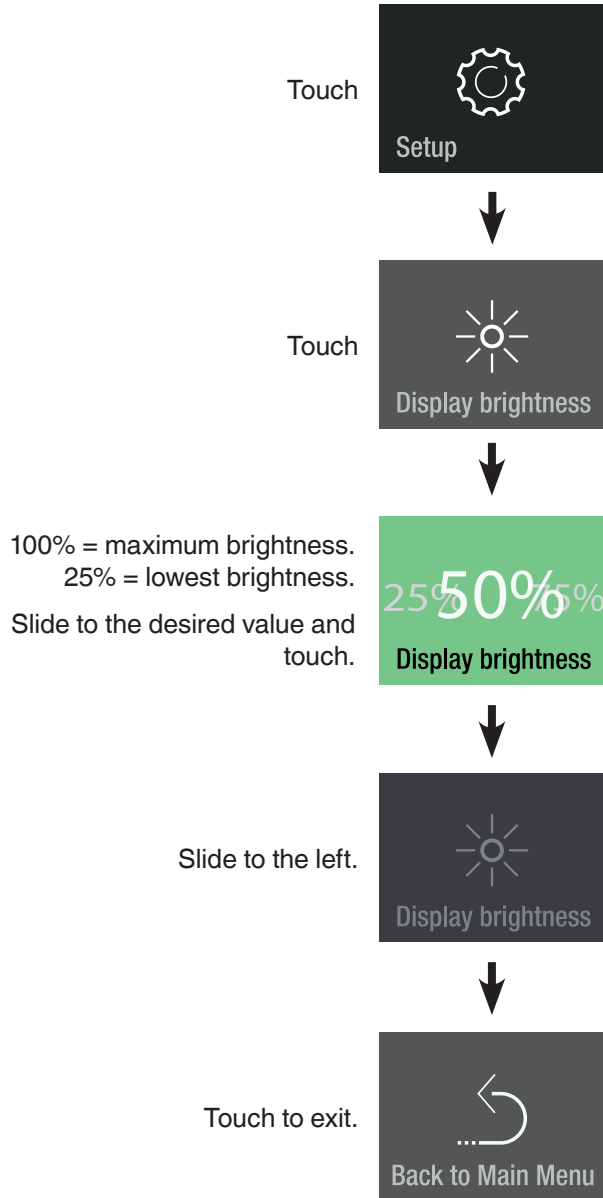

Language



Units

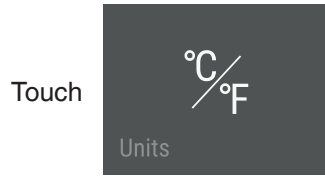

Slide to the desired temperature unit and touch

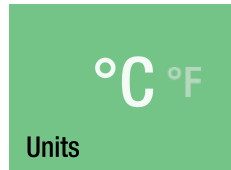

Slide to the left.

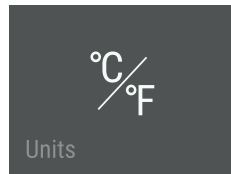

Touch to exit.

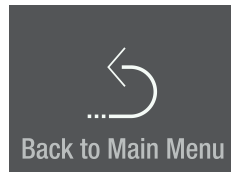

SmartDeviceBox (Not Supplied in All Countries)

The appliance is ready for integration into a smart home and for extended services.

Other options can be selected with a SmartDeviceBox.

This is activated via the MyLiebherr customer portal.



You will find more information about availability and prerequisites and the individual options on the website www.smartdevice.liebherr.com/info.

Download the "SmartDevice App" to your smartphone.

Start the app on your smartphone and follow the instructions.

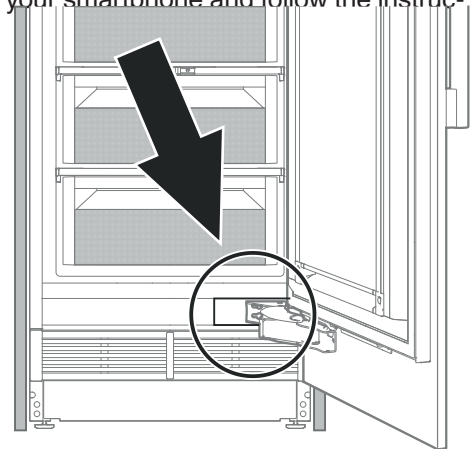

SmartDevice functions are not available in all countries.

Description of the SmartDevice Displays

SmartDeviceBox is inserted.

Hold to configure now.

SDB inserted

Display to start the WLAN connection.



SDB connect

The symbol flashes.
Connection to WLAN is in progress.



SDB connecting

The router credentials are displayed.

Router_0123456789
01234567890123456

Connecting to:

Appliance is connected to WLAN.



SDB Connected

Connection reset

Reset SDB connection?

This message informs you of any router or Internet problems.



No connection

Alarm Messages

Door Open Alarm

Door has been left open for longer than about 180 seconds.



Close the door

Action

Close the appliance door.

Electronic Fault Alarm

Electronic fault.



Device failure

Touch

Action

Contact service, stating the failure code displayed.

Failure XX0000
Please contact service

Touch

Device failure

Touch

Device failure

Press

Press for approx. 2 seconds to read failure number again.

38 °F

Refrigerator

Connection Failure

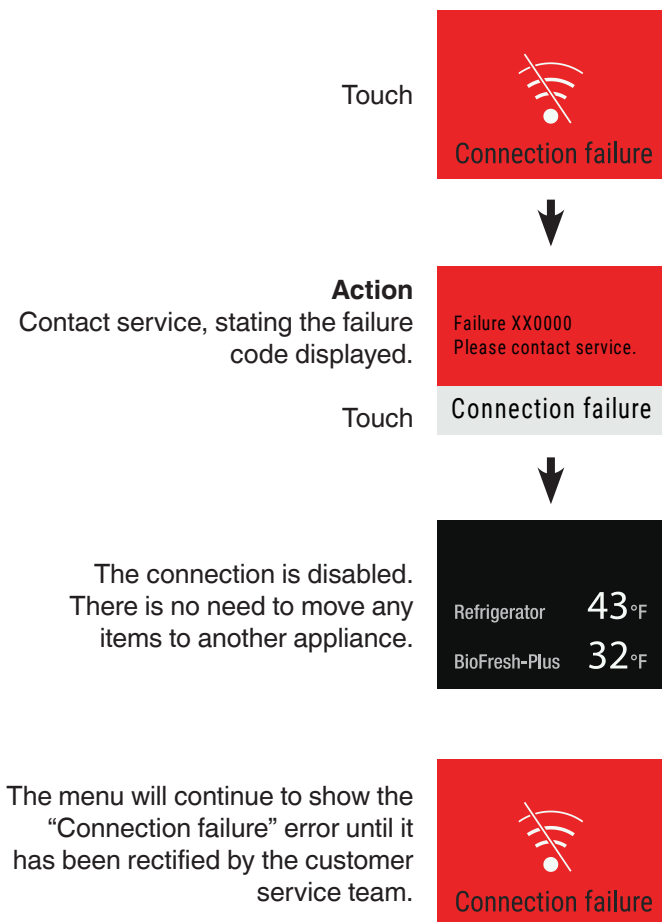

Interior Light

The interior light is located at the left and right in the refrigerator compartment and at the top of the BioFresh compartment. It turns on when the appliance door is opened.

The light intensity of the LED light corresponds to laser class 1/1M.

IMPORTANT

The light cover may only be removed by customer service staff.

⚠ CAUTION!

Risk of eye damage.

If the cover is removed, do not look directly at the light through optical lenses from a close distance.

Equipment

You can rearrange the height of the shelves and door racks as required.

⚠ CAUTION!

Risk of injury and damage.

Do not attempt to adjust a shelf or door rack with food on it.

Only adjust an empty shelf or door rack.

Repositioning the shelves

Removing

Lift the shelf up and move out toward you.

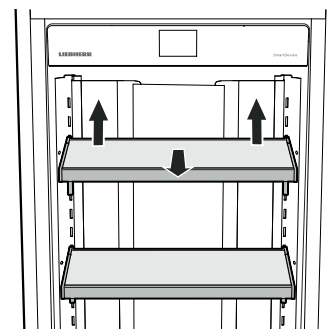

Installing

Insert the hooks of the shelf into the openings of the clip-in strip at the desired height and push down.

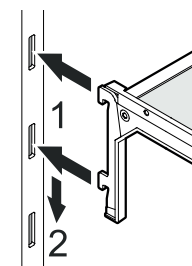

Repositioning the door racks

Removing

Lift the rack up and move out toward you.

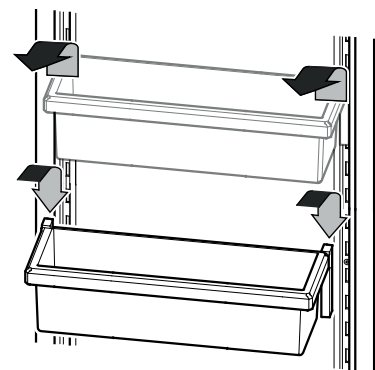

Installing

Insert the hooks of the rack into the openings of the clip-in strip at the desired height and push down.

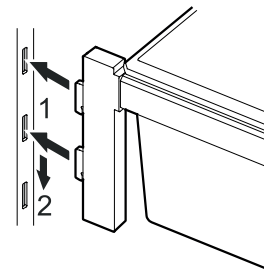

BioFRESH COMPARTMENT

Gallon rack bottle holder

You can protect the bottles from falling over when the door is opened and closed.

Move the bottle holder to the desired position. Always hold at the front when moving.

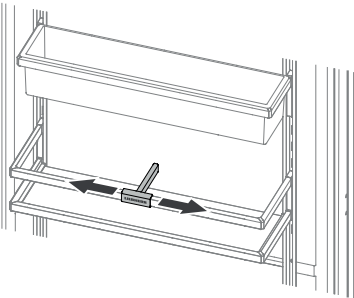

Bottle tray

The tray above the BioFresh compartment can be used for storing bottles horizontally.

Remove glass plate.

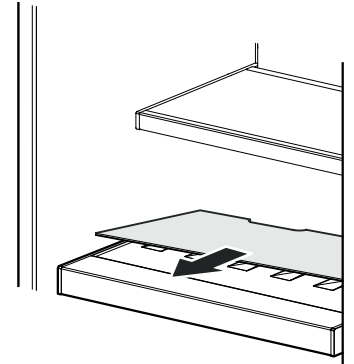

IMPORTANT

When storing tall bottles (higher than 9 inches), the gallon rack must be relocated to a higher position to avoid collision between the gallon rack and the bottles.

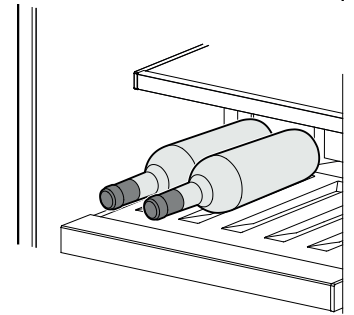

Water Dispenser

(models MRB 3000, MRB 3600 only)

Press a drinking glass against the bottom part of the dispenser. The top part moves out and the water flows into the glass.

(max. time 2 min → waiting time before reuse 4 min)

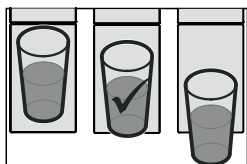
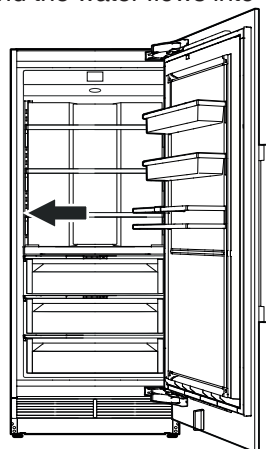
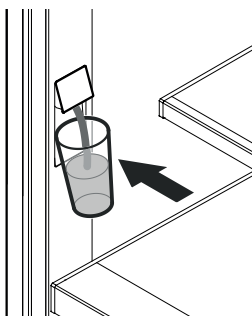

Note

The water temperature is determined by the appliance setting and the water intake temperature.

BioFresh Compartment

The BioFresh compartment maintains food freshness up to 3 times longer than in standard refrigerators. The temperature in the upper two drawers is kept constantly at approx. 32°F. These drawers are equipped with humidity control to provide ideal storage conditions for different types of food.



Slide control to right

(dry setting)

This setting is suitable for dry or wrapped food like dairy products, meat, cold cuts.



Slide control to left

(humid setting)

This setting is suitable for storing unwrapped food with a high moisture content such as salad, vegetables and fruit.

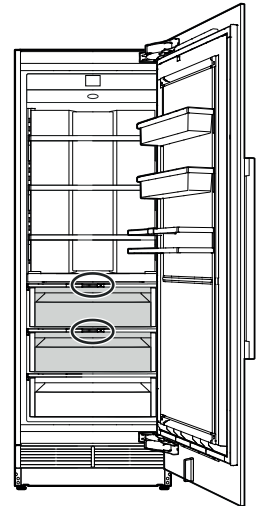

Notes

- The humidity in the compartment depends on the moisture content of the food and the frequency with which a drawer is opened.
- The fresher the product and the higher its quality, the longer the storage life.
- Unwrapped food should be stored separately. Wrap food if there is not enough space in the drawers. To avoid bacterial spoilage, different types of meat should not come into contact with each other. Keep meat packed separately.
- The following products should not be stored in the BioFresh compartment: hard cheese, potatoes, cold-sensitive vegetables such as cucumber, eggplant, avocados, semi-ripe tomatoes, zucchini, and all cold-sensitive tropical fruits.

BioFresh-Plus Compartment

Set the temperature of the BioFresh-Plus compartment in accordance with the type of stored food. See chapter "Changing the BioFresh-Plus Compartment Temperature".

Set to 32°F (factory setting) for storing wrapped food like meat, sausage or dairy products. These storing conditions are the same as in the BioFresh compartment at dry setting.

Set to 28°F for storing of fish or seafood. Storage time is 3 days at the most.

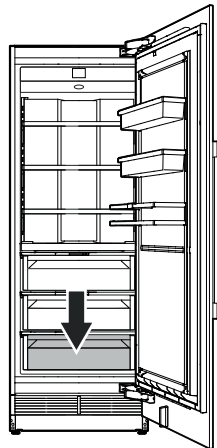

Storage Times (days) for food in the BioFresh compartment at dry setting or in the BioFresh-Plus compartment at 32°F temperature setting

poultry.....	up to	5
milk (fresh).....	up to	7
pork, beef, game, sausage, cold cuts.....	up to	7
butter, cheese.....	up to	30

Storage Times (days) for food in the BioFresh compartment at humid setting

green onions, mushrooms, spinach	up to	7
lettuce, peas	up to	10
asparagus, broccoli, Chinese cabbage curly kale, kohlrabi, radishes	up to	14
cauliflower, fennel, lamb's lettuce radicchio, iceberg lettuce, endives	up to	21
brussels sprouts, celery, chicory, herbs.....	up to	30
leeks, savoy cabbage.....	up to	60
carrots	up to	150
cabbage, garlic.....	up to	180

raspberries, strawberries.....	up to	5
blackberries, figs (fresh).....	up to	7
apricots, bilberries, cherries	up to	14
black and red currants, gooseberries plums, rhubarb	up to	21
peaches.....	up to	30
dates (fresh)	up to	60
grapes, quinces.....	up to	90
kiwi fruit, pears.....	up to	120
apples.....	up to	180

Cleaning



WARNING!

- To prevent possible injury due to an electric shock, be sure to disconnect the power cord or turn off the circuit breaker before cleaning the appliance.
- To avoid injury or damage, do not use steam cleaning equipment to clean the appliance.
- To avoid short-circuits, ensure no cleaning water penetrates into the electrical components when cleaning the appliance. Do not use a sponge or cloth that is overly wet.
- Remove all food from the refrigerator and BioFresh compartment and store in a cool place temporarily.
- Remove the glass shelves and door racks. Refer to chapter **Equipment**.

- Remove the Biofresh drawers.  Pull the drawer straight out, grip at the back and lift out.

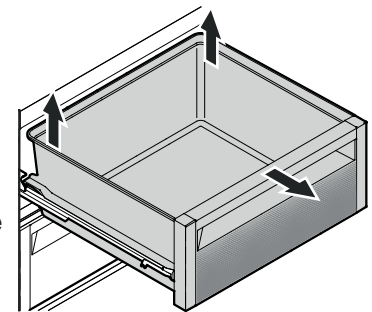

- Clean the inside of the appliance and equipment parts with lukewarm water and a little detergent.

IMPORTANT

Do not use abrasive or scouring pads or sponges. Do not use concentrated cleaning agents. Never use abrasive or acid-based cleaners or chemical solvents.

- Clean the pull-out rails with a slightly dampened cloth only. 

IMPORTANT

No cleaning water must be allowed to get into the pull-out rail guides.

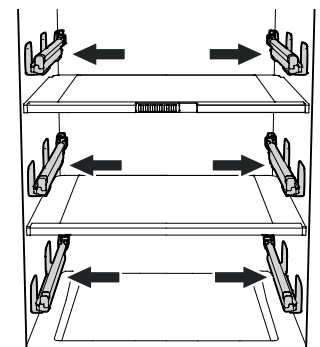

- Dry all parts well with a cloth.

CLEANING

- **Do not** damage or remove the model plate on the inside of the appliance. It is very important for servicing your appliance.

- Install the BioFresh drawers. Place the drawer on the rails. The rails must be fully extended and aligned with the front of the drawer. Slide the drawer in.

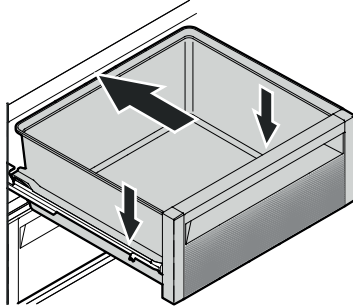

- Install all equipment parts and replace the food in the appliance. Refer to chapter **Equipment**.
- Turn the appliance on.

Maintenance Menu

Maintenance can be carried out independently of the specified regular intervals. The maintenance menu includes the following steps.

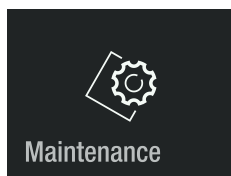

Complete cleaning
For complete maintenance of the appliance.

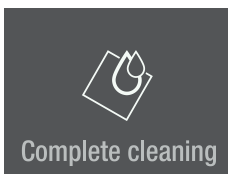

Please exchange water and air filters.
Hold to continue.

Please flush 1.5l of water through dispenser.
Hold to reset timer.

Please clean the ventilation grill in your appliance's toe kick area.

Dispenser cleaning
To interrupt the water supply for cleaning the dispenser outlet.

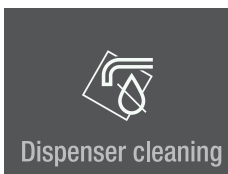

Please clean water dispenser.
Hold to activate water dispenser.

New water filter
To flush and reset maintenance timer.

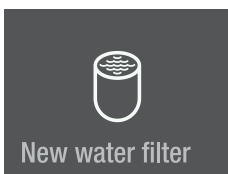

Please exchange water filter.
Hold to continue.

Please flush 1.5l of water through dispenser.
Hold to reset timer.

New air filter
To reset maintenance timer.

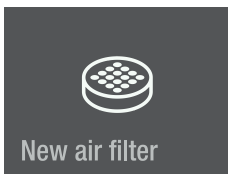

Please exchange air filter.
Hold to reset timer.

Flush cleaning
To flush the water dispenser when the dispenser has not been used for a longer period of time.

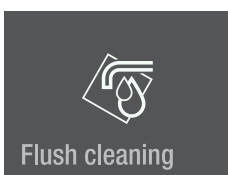

Please flush 1.5l of water through dispenser.
Hold to confirm.

To return to the main menu.

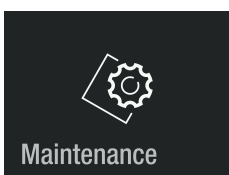
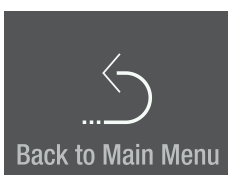

Maintenance

New water filter

(models MRB 3000, MRB 3600 only)

The inserted water filter absorbs deposits in the water and reduces the taste of chlorine.

IMPORTANT

To avoid reduction of the water flow rate of the dispenser, the water filter should be changed at least at the indicated maintenance intervals.

If noticeable water flow reduction occurs, the water filter should be changed sooner.

Note

It is not necessary to turn off the water supply when removing or inserting the filter.

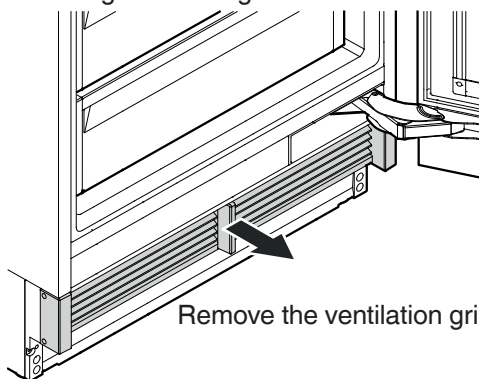

Remove the ventilation grille.

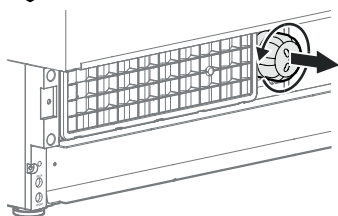

Turn the water filter counterclockwise and remove.

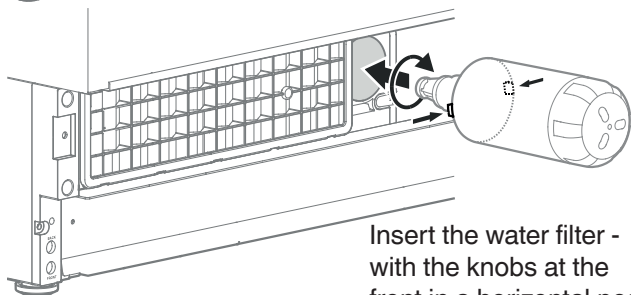

Insert the water filter - with the knobs at the front in a horizontal position - as far as it will go, and turn clockwise until it snaps in.

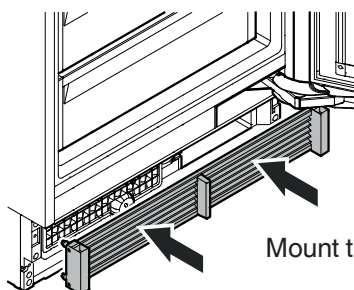

Mount the ventilation grille.

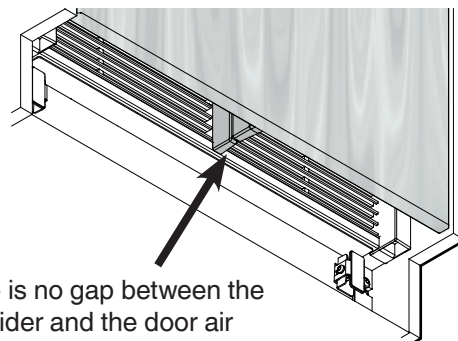

Check that there is no gap between the appliance air divider and the door air divider.

IMPORTANT

There will be a gap if the ventilation grille is fitted incorrectly.

Touch

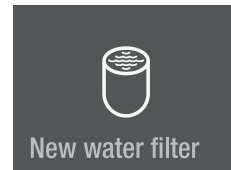

Press

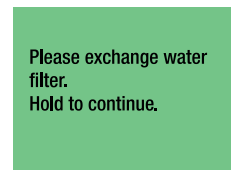

Press

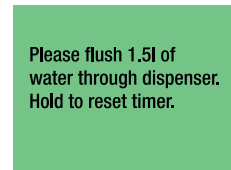

Flush approx. 1.5 quarts of water through the dispenser and discard.

The timer for water filter change is reset.

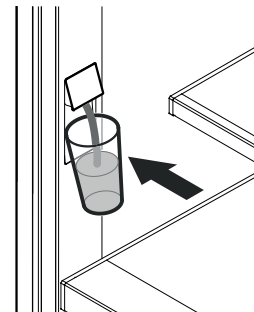

Slide 3 times to the left.

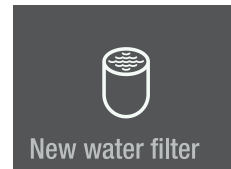

Touch to exit.

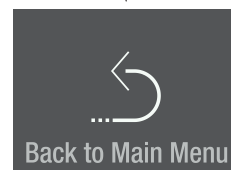

Dispenser cleaning

(models MRB 3000, MRB 3600 only)

The dispenser outlet and the surrounding area can be cleaned without disconnecting the appliance from the electrical power supply.

Touch



Message

Please clean water dispenser.
Hold to activate water dispenser.

The water supply is stopped now.

- Press in the bottom part of the dispenser so that the top part moves out.
- Clean the water outlet and the surrounding area.
- Release the bottom part of the dispenser.

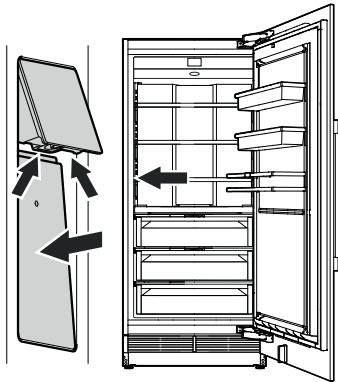

Press

Please clean water dispenser.
Hold to activate water dispenser.



The water dispenser is ready for use again.



If the water flow is no longer even, the aerator must be replaced (see contact details on the back of this manual).

New air filter

The air filter absorbs odors from the appliance interior. It should be changed at least at the indicated maintenance intervals.

Touch



Message

Please exchange air filter.
Hold to reset timer.

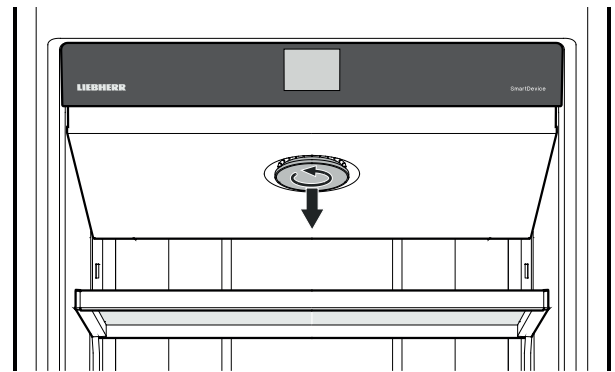

Turn the cover counterclockwise and remove.

Turn the air filter counterclockwise and remove.

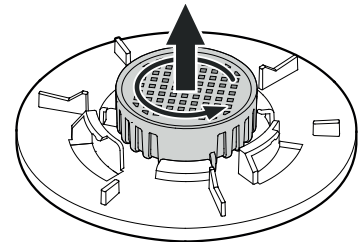

Insert the new air filter and turn clockwise until it snaps in.

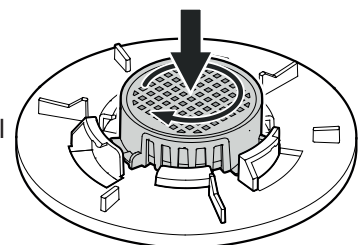

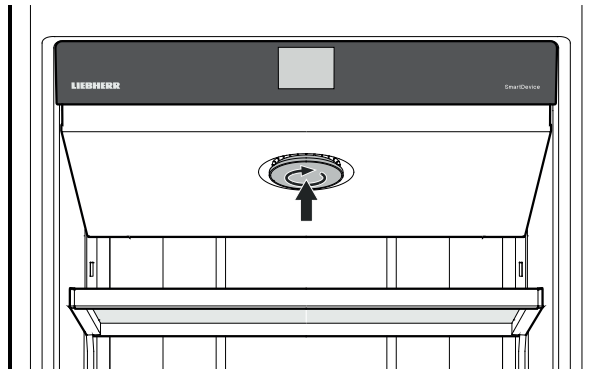

Insert the cover and turn clockwise until it snaps in.

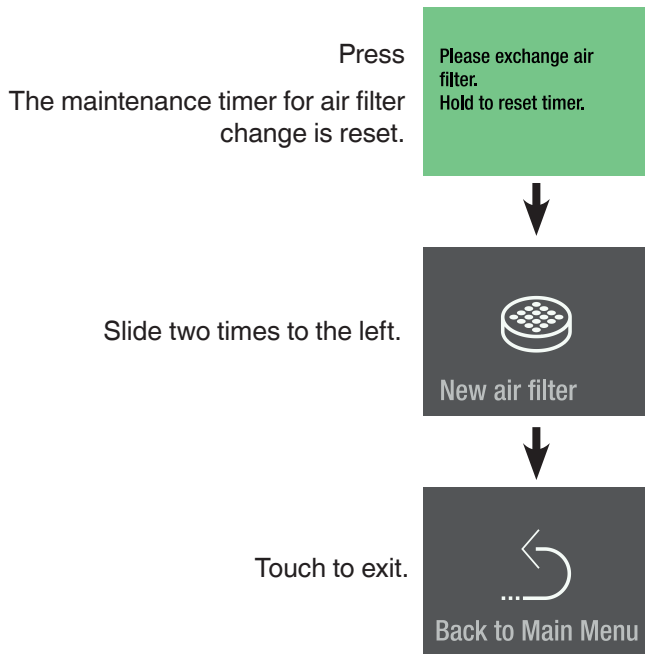

Flush cleaning

(models MRB 3000, MRB 3600 only)

When the water dispenser has not been used for one week or more, flush the pipeline.

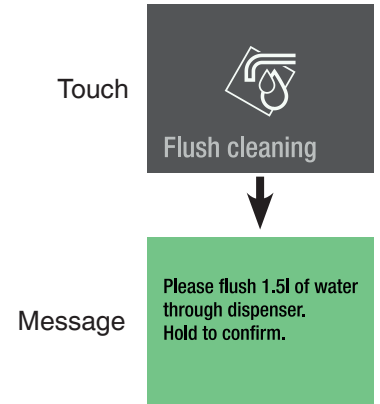

Flush approx. 1.5 quarts of water through the dispenser and discard.

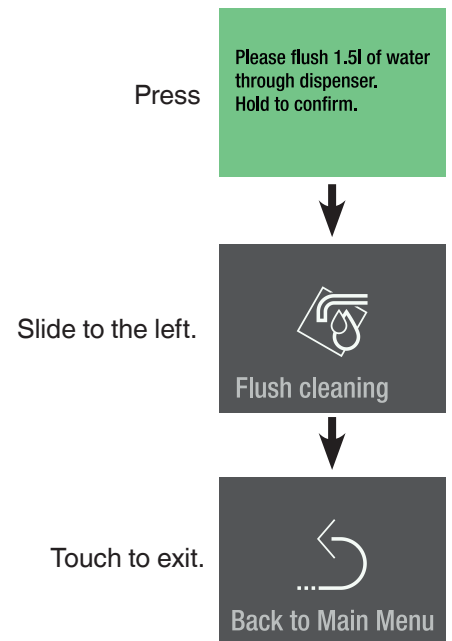
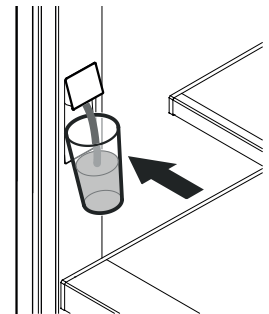

Cleaning the dust filter

Clean the dust filter in the toe kick area at least at the indicated maintenance intervals.

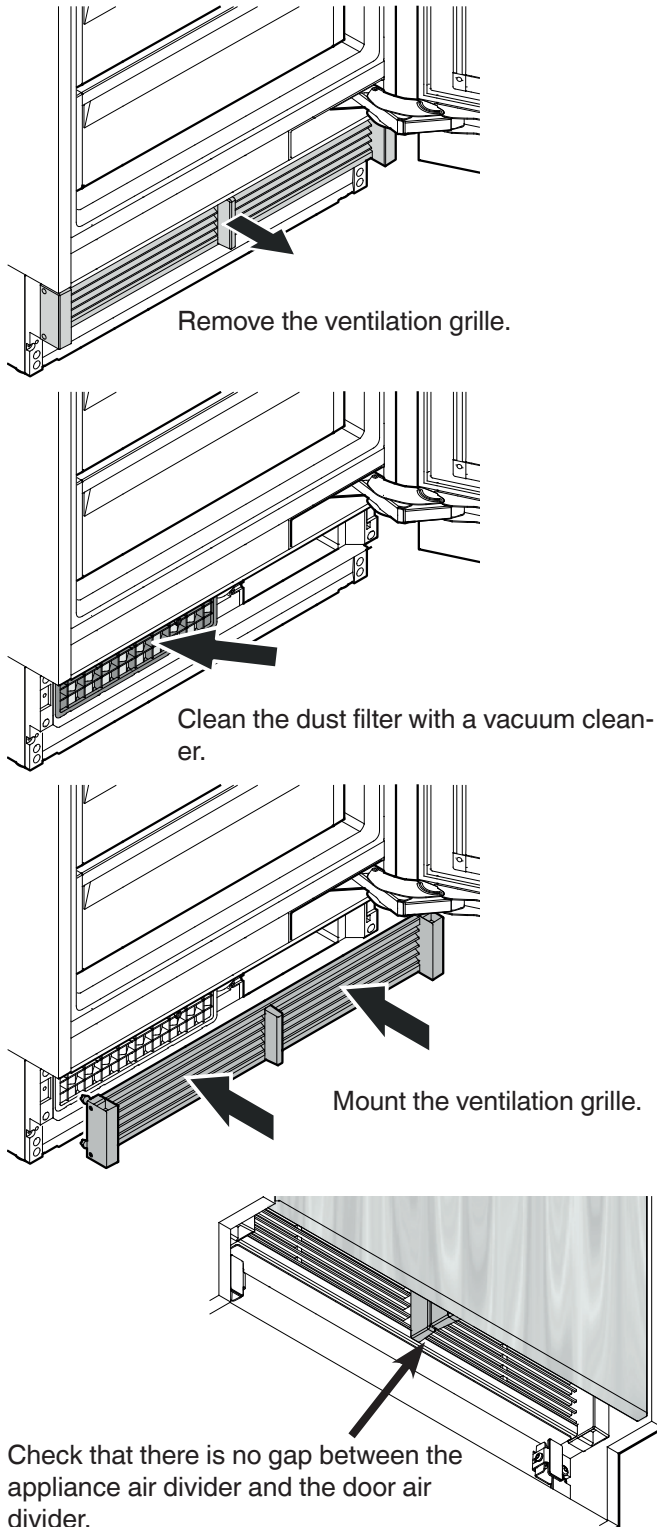

IMPORTANT

There will be a gap if the ventilation grille is fitted incorrectly.

Additional Functions

BioFresh temperature adjustment
 BioFresh-Plus temperature adjustment
 Activating the defrost function manually
 Reset to factory setting
 DemoMode

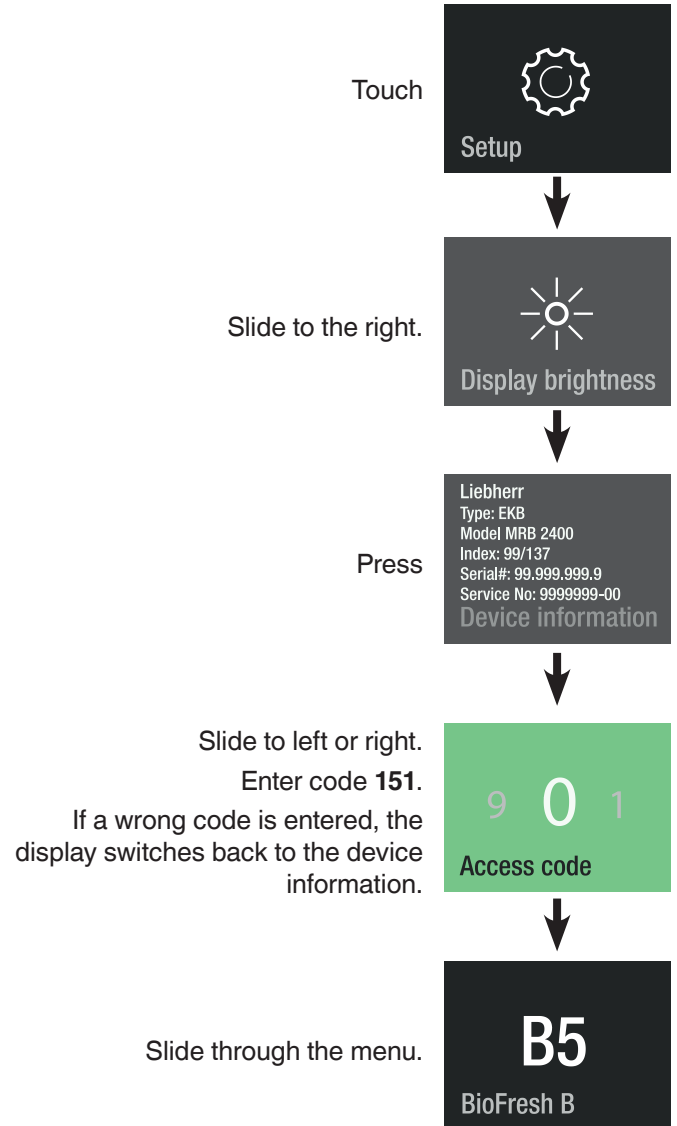

ADDITIONAL FUNCTIONS

BioFresh temperature adjustment

The temperature in the upper two drawers is kept constantly at approx. 32°F. It can be adjusted to slightly warmer or colder.

BioFresh-Plus temperature adjustment

The temperature in the bottom drawer is selectable between 32°F or 28°F. Both fixed temperature settings can be adjusted respectively to slightly warmer or colder.

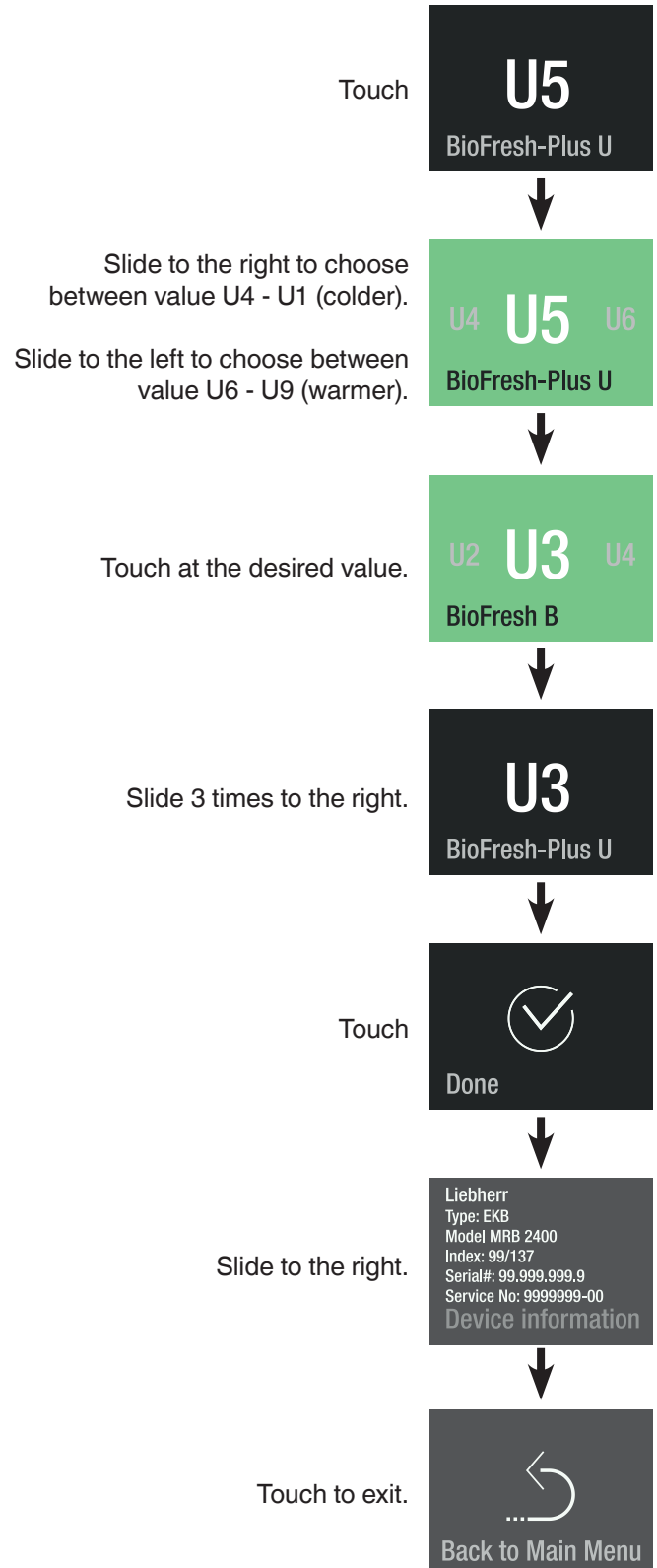
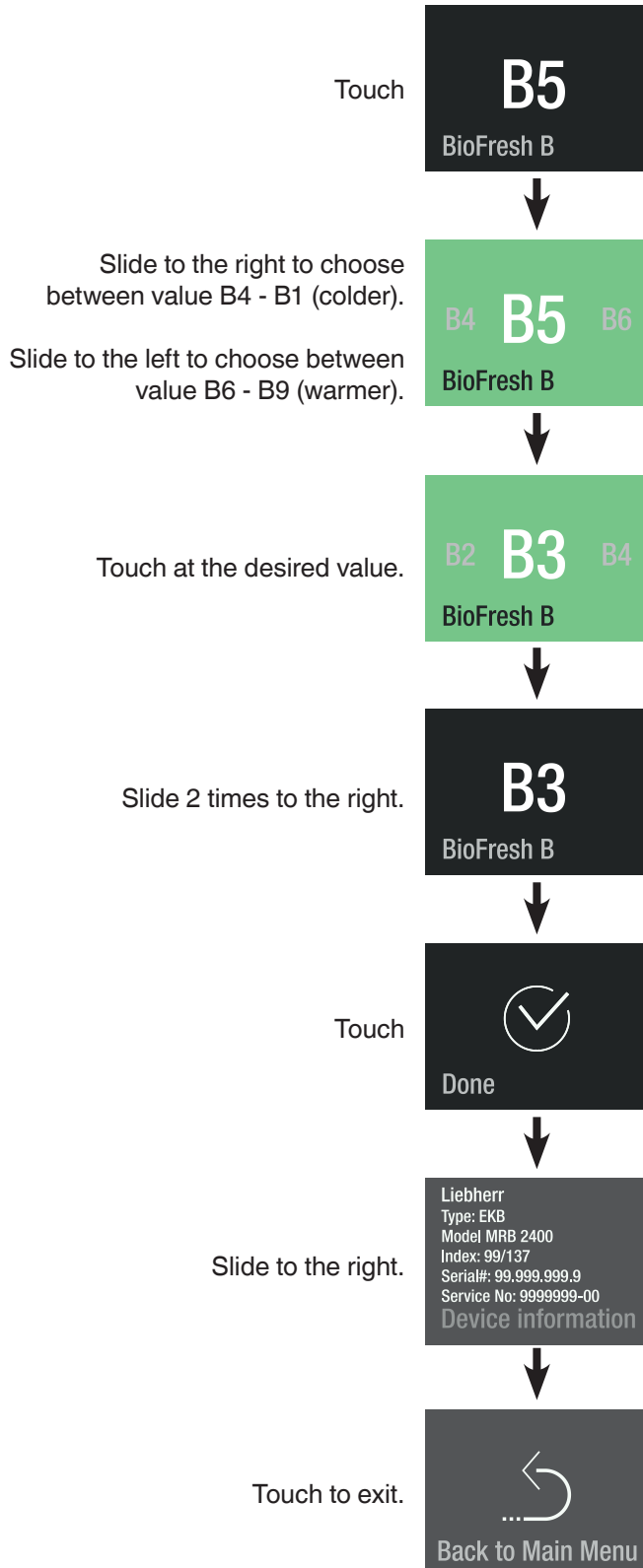

Manual defrost

The appliance defrosts automatically. The defrost function can be activated manually for service applications.

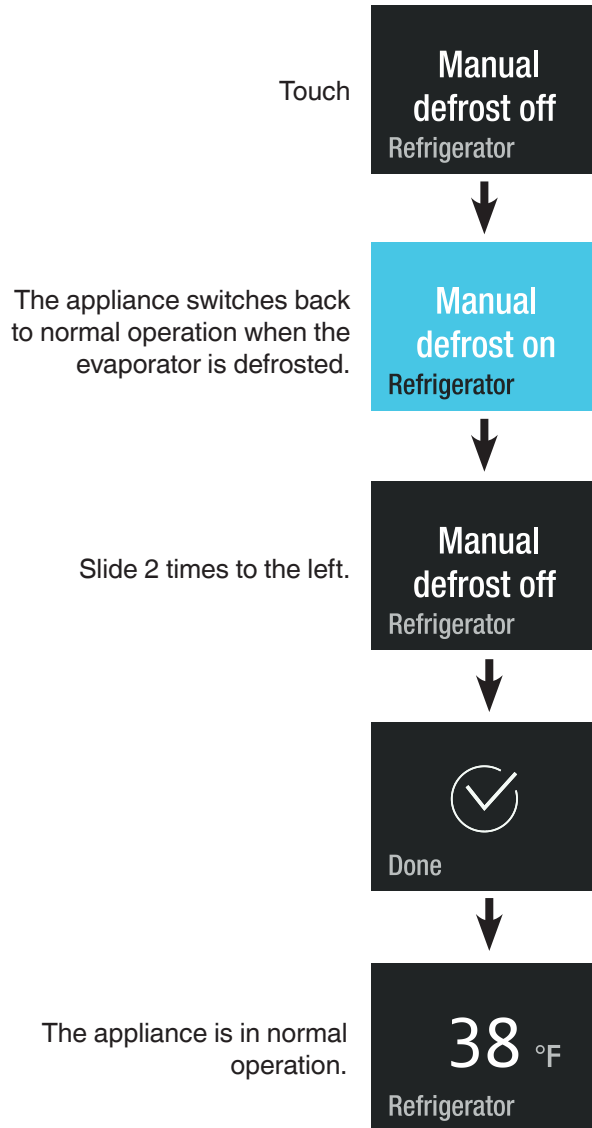

Reset

The electronic control can be reset to factory settings using this function.

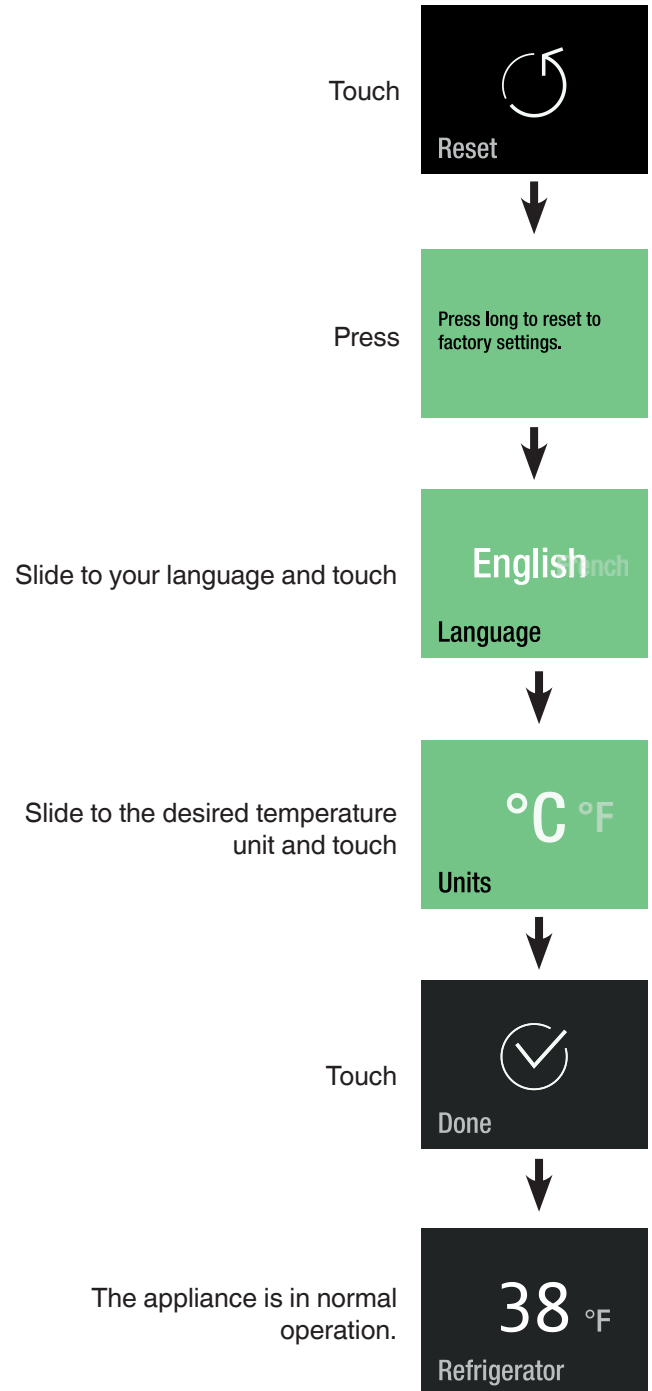

ADDITIONAL FUNCTIONS

DemoMode

DemoMode can be activated for presenting the appliance at exhibitions or in salesrooms as if it were in normal operating mode.

Activating DemoMode

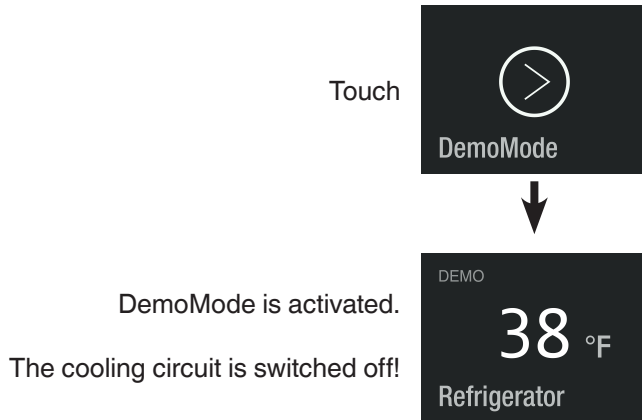

Deactivating DemoMode

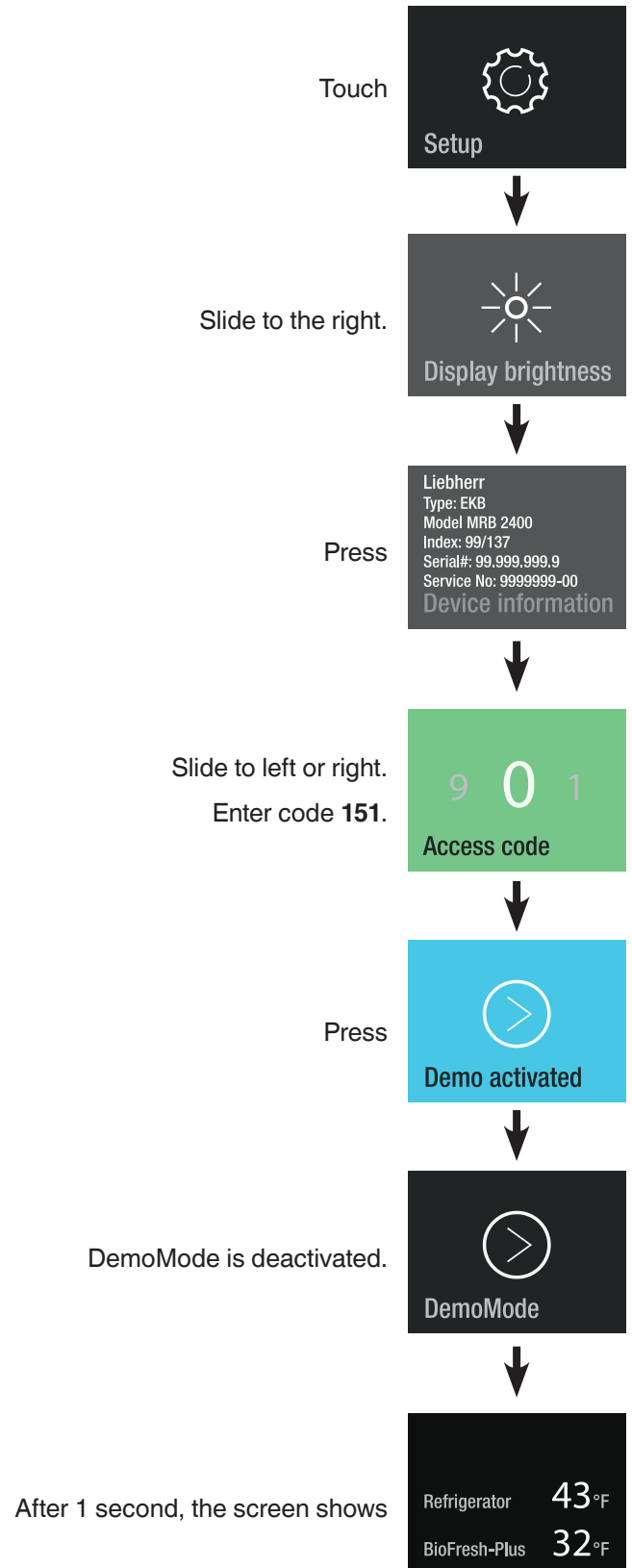

Troubleshooting

If a problem occurs during operation, check whether it is due to an operating error. Please note that even during the warranty period, some repair costs may be your responsibility.

You may be able to correct the following faults by checking the possible causes yourself:

Problem	Possible Cause and Remedy
Appliance does not work, display is off	<ul style="list-style-type: none"> - Is the appliance turned on properly? - Is the power cord properly inserted in the outlet? - Is the circuit breaker or fuse in operating condition?
The interior light does not come on	<ul style="list-style-type: none"> - Is the appliance turned on?
Motor seems to run too long	<ul style="list-style-type: none"> - Is the ambient temperature too high? See Safety Regulations. - Has the appliance been opened too often or left open too long? - A large amount of food has been added. - Unit is in SuperCool mode or PartyMode. Verify unit is in normal operating mode.
The temperature is not cold enough	<ul style="list-style-type: none"> - Is the temperature setting correct? See Setting the Refrigerator Compartment Temperature. - Has an excessive amount of fresh food been placed in the appliance? - Does a separately installed thermometer show the correct reading? - Is the ventilation system working properly? - Is the appliance set up too close to a heat source?

Customer Service

If none of the above possible causes apply, and you can not rectify the fault yourself, contact your nearest customer service representative.

Indicate the type **(1)** of appliance, service number **(2)** and the appliance / serial number **(3)** as indicated on the model plate or in the device information in the setup menu of the electronic control.

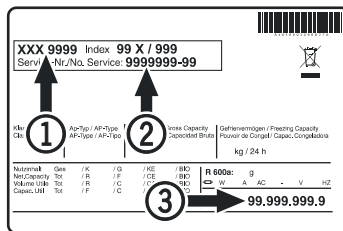

Appliance Information

Record this information when the appliance is installed.

Type Designation: _____

Service Number: _____

Appliance / Serial Number: _____

Date of Purchase: _____

Where Purchased: _____

The position of the model plate is shown in the section entitled **Description of the Appliance**.

For Service in the U.S.

Liebherr Service Center

Toll Free: **1-866-LIEBHER** or **1-866-543-2437**

Email: Service-appliances.us@liebherr.com

PlusOne Solutions, Inc.

3501 Quadrangle Blvd, Suite 120

Orlando, FL 32817

For Service in Canada

Liebherr Service Center

Toll Free: **1-888-LIEBHER** or **1-888-543-2437**

www.euro-parts.ca

EURO-PARTS CANADA

39822 Belgrave Road

Belgrave, Ontario, N0G 1E0

Phone: (519) 357-3320

Fax: (519) 357-1326



www.liebherr-appliances.com