

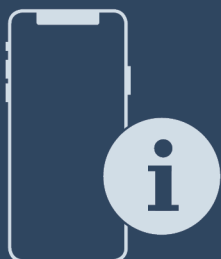

User Guide

Quality, Design and Innovation





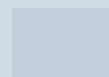



















[home.liebherr.com/fridge-manuals](http://home.liebherr.com/fridge-manuals)



# LIEBHERR

# Contents

<b>1</b>	<b>Appliance at a glance.....</b>	<b>3</b>
1.1	Scope of delivery.....	3
1.2	Overview of appliances and equipment.....	3
1.3	SmartDevice.....	3
1.4	Appliance range of use.....	4
1.5	Conformity.....	4
1.6	SVHC substances according to REACH regulation.....	4
1.7	EPREL database.....	4
<b>2</b>	<b>General safety instructions.....</b>	<b>4</b>
<b>3</b>	<b>Functionality of the Touch &amp; Swipe display.....</b>	<b>6</b>
3.1	Navigation and symbol explanation.....	6
3.2	Menus.....	6
3.3	Sleep mode.....	7
<b>4</b>	<b>Putting into operation.....</b>	<b>7</b>
4.1	Switching on appliance (first use).....	7
4.2	Starting the IceMaker for the first time.....	7
<b>5</b>	<b>Storage.....</b>	<b>7</b>
5.1	Information regarding storage.....	7
5.2	Freezer compartment.....	8
5.3	Storage times.....	8
<b>6</b>	<b>Saving energy.....</b>	<b>9</b>
<b>7</b>	<b>Controls.....</b>	<b>9</b>
7.1	Controls and displays.....	9
7.1.1	Status display.....	9
7.1.2	Display symbols.....	9
7.2	Appliance functions.....	9
7.2.1	Notes on the appliance functions.....	9
	Switching the appliance off and on.....	9
		
	WiFi.....	10
	Temperature.....	11
	Temperature unit.....	11
	SuperFrost.....	11
	Start defrosting cycle.....	12
	PartyMode .....	12
	SabbathMode.....	12
	EnergySaver .....	13
	IceMaker / MaxIce .....	13
	IceMaker water supply.....	15
	TubeClean .....	15
	Status light (status display)*.....	15
	Display brightness.....	16
	Door alarm.....	16
	Input lock.....	16

	Language.....	17
	Device information.....	17
	Software.....	17
	Reminder.....	18
	Demo mode.....	18
	Resetting to factory settings.....	19
7.3	Messages.....	19
7.3.1	Overview of warnings.....	19
7.3.2	Ending warnings.....	19
7.3.3	Overview of reminders.....	20
7.3.4	Ending reminders.....	20
<b>8</b>	<b>Features.....</b>	<b>21</b>
8.1	Drawers.....	21
8.2	Pull-out board with IceTower.....	22
8.3	Glass shelves.....	24
8.4	IceMaker.....	24
8.5	VarioSpace.....	24
8.6	Freezer pack.....	24
<b>9</b>	<b>Maintenance.....</b>	<b>25</b>
9.1	Disassembling / assembling pull-out systems.....	25
9.2	Defrosting the appliance.....	26
9.3	Cleaning the appliance.....	26
<b>10</b>	<b>Customer help.....</b>	<b>27</b>
10.1	Technical specifications.....	27
10.2	Operating noises.....	28
10.3	Technical fault.....	28
10.4	Customer Service.....	30
10.5	Model plate.....	30
<b>11</b>	<b>Shutting down.....</b>	<b>30</b>
<b>12</b>	<b>Disposal.....</b>	<b>30</b>
12.1	Preparing appliance for disposal.....	30
12.2	Disposing of the appliance in an environmentally friendly manner.....	30

The manufacturer is continually working on the further development of all types and models. Please be aware that we reserve the right to make changes to the shape, equipment and technology.

Symbol	Explanation
	<b>Read instructions</b> Please read the information in these instructions carefully to understand all of the benefits of your new appliance.

Symbol	Explanation
	<p><b>Additional information on the Internet</b></p> <p>The digital manual with additional information and in other languages can be found via the QR code on the front of the manual or by entering the service number at <a href="http://home.liebherr.com/fridge-manuals">home.liebherr.com/fridge-manuals</a>.</p> <p>The service number can be found on the serial tag:</p> <p style="text-align: center;"><i>Fig. Example illustration</i></p>
	<p><b>Check appliance</b></p> <p>Check all parts for transport damage. If you have any complaints, please contact your agent or customer service.</p>
	<p><b>Differences</b></p> <p>These instructions apply to a range of models, so differences are possible. Sections that apply to certain models only are marked with an asterisk (*).</p>
	<p><b>Instructions and results</b></p> <p>Instructions are marked with a ▶.</p> <p>Results are marked with a ▷.</p>
	<p><b>Videos</b></p> <p>Videos about the appliances are available on the YouTube channels of Liebherr-Hausgeräte.</p>

These operating instructions apply to:

FN..	52..i
SFN..	52..i

**Note**

If your appliance has an N in its appliance designation, it is a NoFrost appliance.

## 1 Appliance at a glance

### 1.1 Scope of delivery

Check all parts for transport damage. Contact your dealer or customer service in the event of complaints. (see 10.4 Customer Service)

Your new appliance comes with the following parts:

- Standalone appliance
- Features (depending on the model)
- Installation materials (depending on the model)
- "Quick Start Guide"
- "Installation Guide"
- Service Brochure

### 1.2 Overview of appliances and equipment

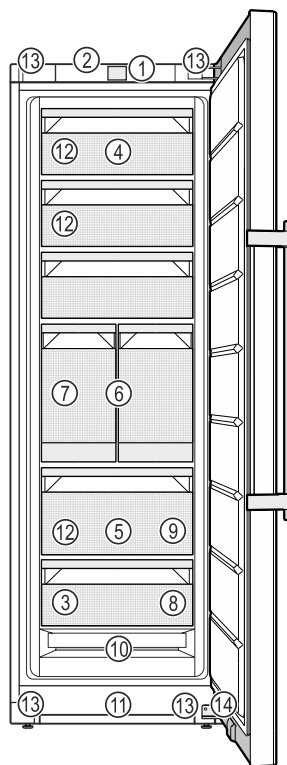

*Fig. 1 Example illustration*

- (1) Controls
- (2) Lighting, status light (status display)\*
- (3) Type plate
- (4) Tilting drawer
- (5) SpaceBox
- (6) IceTower
- (7) IceMaker
- (8) Freezer tray, cold storage accumulator
- (9) Ice cube scoop
- (10) NoFrost
- (11) Ventilation slit
- (12) VarioSpace
- (13) Adjustable feet (front), transport castors (rear), transport handles at the top (rear) and at the bottom (front)
- (14) Soft-closing mechanism\*

**Note**

▶ Shelves, drawers and baskets are arranged for optimum energy efficiency when the appliance is delivered. Changing how the shelves, for example, are inserted in the fridge compartment does not have any impact on energy consumption.

### 1.3 SmartDevice

SmartDevice is the networking solution for your freezer.

If your appliance SmartDevice-enabled or compatible, you can quickly and easily connect your appliance to your WiFi. With the SmartDevice app, you can operate your appliance from a mobile device. Additional functions and setting options are available in the SmartDevice SmartDevice app.

SmartDevice-enabled appliance: Your appliance is capable of being a SmartDevice. To be able to connect your device to WiFi, you need to download the SmartDevice app.

# General safety instructions



More information about SmartDevice: [smartdevice.liebherr.com](http://smartdevice.liebherr.com)

Downloading the SmartDevice app:



After installing and configuring the SmartDevice, you can connect your appliance to the WiFi using the SmartDevice app and the WiFi appliance function (see WiFi).

## Note

The SmartDevice function is not available in the following countries: Russia, Belarus, Kazakhstan.

## 1.4 Appliance range of use

### Intended use

The appliance is only suitable for cooling food products in a domestic or household-like environment. This includes, for example, use:

- in staff kitchens, bed and breakfast establishments,
- by guests in country houses, hotels, motels and other accommodation,
- for catering and similar services in the wholesale trade.

The appliance is not suitable as a built-in unit.

All other types of use are not permitted.

### Foreseeable misuse

The following applications are expressly forbidden:

- Storing and refrigerating medicines, blood plasma, laboratory preparations or similar substances and products based on the Medical Device Directive 2007/47/EC
- Use in areas at risk of explosions

Misusing the appliance may lead to damage to the goods stored or they may spoil.

### Climate classifications

Depending on the climate classification the appliance is designed to operate in restricted ambient temperatures. The climate classification applying to your appliance is printed on the rating plate.

## Note

► Keep to the specified ambient temperatures in order to guarantee that the appliance works properly.

Climate classification	for ambient temperatures of
SN	10 °C to 32 °C
N	16 °C to 32 °C
ST	16 °C to 38 °C
T	16 °C to 43 °C
SN-ST	10 °C to 38 °C
SN-T	10 °C to 43 °C

## 1.5 Conformity

The refrigerant circuit has been tested for leaks. The appliance complies with the applicable safety regulations and with the corresponding directives.

For the EU market: The appliance complies with directive 2014/53/EU.

For the GB market: The appliance complies with Radio Equipment Regulations 2017 SI 2017 No. 1206.

The full text of the EU Declaration of Conformity is available on the following website: [www.Liebherr.com](http://www.Liebherr.com)

## 1.6 SVHC substances according to REACH regulation

You can check whether your appliance contains SVHC substances according to REACH regulation at the following link: [home.liebherr.com/de/deu/de/liebherr-erleben/nachhaltigkeit/umwelt/scip/scip.html](http://home.liebherr.com/de/deu/de/liebherr-erleben/nachhaltigkeit/umwelt/scip/scip.html)

## 1.7 EPREL database

Details about energy labelling and ecodesign requirements will be available on the European product database (EPREL) from 1st March 2021. You can access the product database at the following link: <https://eprel.ec.europa.eu/> You will be asked to enter the model ID. You can find the model ID on the nameplate.

## 2 General safety instructions

Please keep these operating instructions in a safe place so you can refer back to them at any time.

If you pass the appliance on, please hand these operating instructions to the next user.

Read these operating instructions carefully before use to ensure safe and correct use of the appliance. Follow the instructions, safety instructions and warning messages included at all times. They are important for ensuring you can operate and install the appliance safely and without any problems.

## Danger for the user:

- This appliance can be used by children, as well as persons with limited mental, sensory and physical capabilities or with a lack of experience and knowledge, if supervised or following instruction regarding safe use of the appliance, and if they understand the dangers associated with it. Children must not play with the appliance. Cleaning and user maintenance shall not be made by children without supervision. Children aged from 3 to 8 years are allowed to load and unload refrigerating appliances. Children under 3 years of age must be kept away from the appliance unless constantly supervised.
- The socket must be easily accessible so that the appliance can be disconnected quickly from the electricity in an emergency. It must not be located in the area behind the appliance.
- When disconnecting the appliance from the supply, always take hold of the plug. Do not pull the cable.
- In the event of a fault pull out the mains plug or deactivate the fuse.
- Do not damage the mains power cable. Do not operate the appliance with a defective mains power cable.
- Only customer service or other specially trained staff may repair or perform other operations on the appliance.
- Only assemble, connect and dispose of the appliance according to the instructions.
- The manufacturer is not liable for damage caused by a faulty fixed water connection.

## Fire hazard:

- The coolant used (information on the model plate) is ecofriendly but also flammable. Any leaking coolant may ignite.
  - Do not damage the refrigerant circuit pipes.
  - Do not handle ignition sources inside the appliance.
  - Do not use electrical appliances inside the appliance (e.g. steam cleaners, heaters, ice cream makers, etc.).
  - If the refrigerant leaks: remove any naked flames or ignition sources from the vicinity of the leakage point. Properly air the room. Inform customer services.
- Do not store explosives or sprays using combustible propellants such as butane, propane, pentane, etc. in the appliance. To identify these spray cans, look for the list of contents printed on the can, or a flame

symbol. Gases possibly escaping may ignite due to electrical components.

- Keep burning candles, lamps and other items with naked flames away from the appliance so that they do not set the appliance on fire.
- Please be sure to store alcoholic drinks or other packaging containing alcohol in tightly closed containers. Any alcohol that leaks out may be ignited by electrical components.

## Danger of tipping and falling:

- Do not misuse the plinth, drawers, doors etc. as a step or for support. This applies particularly to children.

## Danger of food poisoning:

- Do not consume food which has been stored too long.

## Danger of frostbite, numbness and pain:

- Avoid prolonged skin contact with cold surfaces or refrigerated/frozen goods or take protective measures, e.g wear gloves.

## Danger of injury and damage:

- Hot steam can lead to injury. Do not use electrical heating or steam cleaning equipment, open flames or defrosting sprays to defrost.
- Do not use sharp implements to remove the ice.

## Risk of crushing:

- Do not hold the hinge when opening and closing the door. Fingers may get caught.

## Symbols on the appliance:



This symbol may be located on the compressor. It relates to the oil in the compressor and makes reference to the risk that: Swallowing or inhaling can be fatal. This advice is only relevant to recycling. There is no danger in normal operation.



This symbol is located on the compressor and indicates the danger of flammable materials. Do not remove the sticker.



This or a similar sticker may be located on the rear of the appliance. This sticker indicates that there are vacuum insulation panels (VIP) or perlite panels in the door and/or housing. This advice is only relevant to recycling. Do not remove the sticker.

## Please note the warning messages and other specific advice in the other chapters:

# Functionality of the Touch & Swipe display

	DANGER	indicates an immediately hazardous situation which will lead to death or serious injuries if it is not avoided.
	WARNING	indicates a hazardous situation which may lead to death or serious injuries if it is not avoided.
	CAUTION	indicates a hazardous situation which may lead to minor or moderate injuries if it is not avoided.
	NOTICE	indicates a hazardous situation which may lead to damage to property if it is not avoided.
	Note	indicates useful instructions and tips.

## 3 Functionality of the Touch & Swipe display

You operate your appliance using the Touch & Swipe display. You select appliance functions in the Touch & Swipe display (hereafter referred to as display) by tapping them. If you do not perform any action on the display for 10 seconds, the display either jumps back to the higher-level menu or directly to the status display.

### 3.1 Navigation and symbol explanation

In the illustrations, different symbols are used to navigate the display. The following table describes these symbols.

Symbol	Description
	<b>Briefly touch the display:</b> Activates/deactivates function. Confirms selection. Opens submenu.
	<b>Touch the display for a specified time (e.g. 3 seconds):</b> Activates/deactivates function or value.
	<b>Swipe left or right:</b> Navigate in the menu.
	<b>Briefly touch the Back symbol:</b> Jumps back one menu level.
	<b>Press and hold the Back symbol for 3 seconds:</b> Jumps back to the status display.
	<b>Arrow with clock:</b> It takes more than 10 seconds for the following message to appear in the display.

Symbol	Description
	<b>Arrow with a time indication:</b> It takes the specified amount of time until the following message appears in the display.
	<b>“Open Settings menu” symbol:</b> Navigates to the Settings menu and opens the settings menu. If necessary: Navigate to the desired function in the Settings menu. (see 3.2.1 Opening the Settings menu)
	<b>“Open Advanced menu” symbol:</b> Navigates to the Advanced menu and opens the advanced menu. If necessary: Navigate to the desired function in the Advanced menu. (see 3.2.2 Opening the expanded menu)
No action for 10 seconds	If you do not perform any action on the display for 10 seconds, the display either jumps back to the higher-level menu or directly to the status display.
Open door and close it again.	If you open the door and immediately close it again, the display jumps directly back to the status display.

Note: Illustrations of the display are shown in the English version.

### 3.2 Menus

The appliance functions are distributed over various menus:

Menu	Description
Main menu	When you switch the appliance on, you are automatically in the main menu. From here you can navigate to the most important appliance functions, to the Settings menu and to the Advanced menu.
Settings menu	The Settings menu contains additional appliance functions for setting up your appliance.
Advanced menu	The advanced menu contains special appliance functions for setting up your appliance. Access to the Advanced menu is protected by the numerical code <b>1 5 1</b> .

#### 3.2.1 Opening the Settings menu

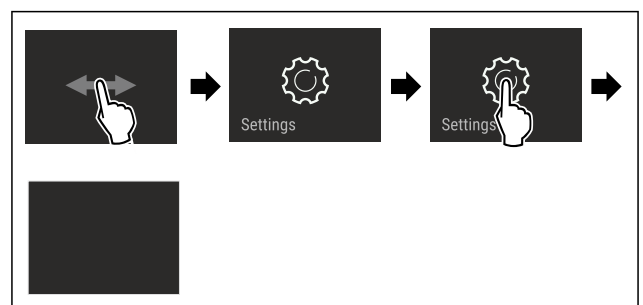

Fig. 2 Example illustration

- ▶ Carry out action steps according to the illustration.
- ▷ Settings menu is open.
- ▶ If necessary: Navigate to the desired function.

## 3.2.2 Opening the expanded menu



Fig. 3

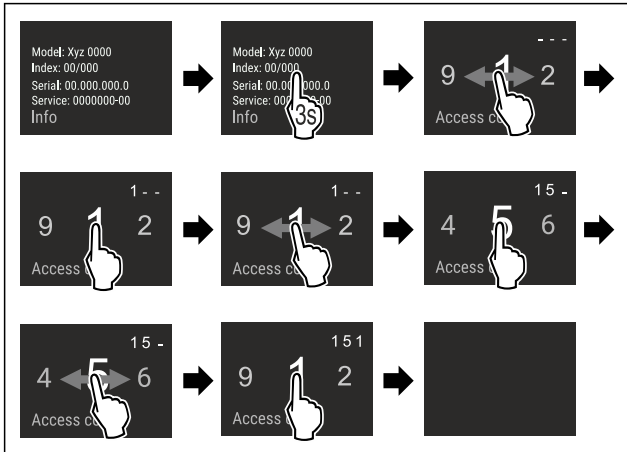

Fig. 4 Example illustration, access with numerical code 151

- ▶ Carry out action steps according to the illustration.
- ▷ The expanded menu is open.
- ▶ If necessary: Navigate to the desired function.

## 3.3 Sleep mode

If you do not touch the display for 1 minute, the display switches to sleep mode. In sleep mode, the display brightness is dimmed.

### 3.3.1 Ending sleep mode

- ▶ Touch the display briefly with your finger.
- ▷ Sleep mode is ended.

## 4 Putting into operation

### 4.1 Switching on appliance (first use)

Make sure that the following requirements are fulfilled:

- The appliance has been installed and connected in accordance with the installation instructions.
- All adhesive strips, adhesive and protective films and transport locks are removed from inside and on the appliance.
- All marketing leaflets are removed from the drawers.
- You are familiar with the functionality of the Touch & Swipe display. (see 3 Functionality of the Touch & Swipe display)

**Switch on the appliance using the Touch & Swipe display:**

- ▶ If the display is in sleep mode: Briefly touch the display.
- ▶ Carry out action steps according to the illustration.

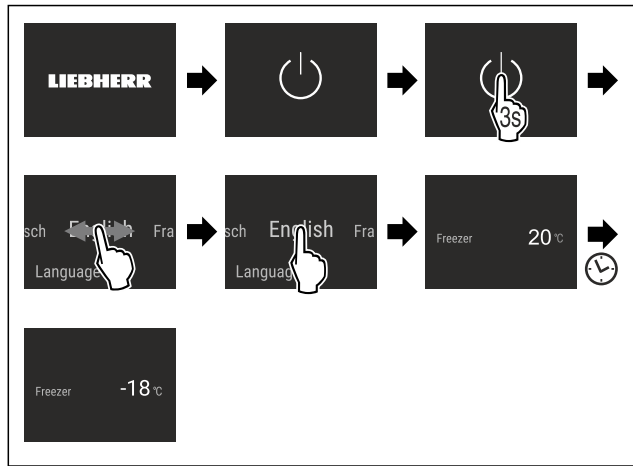

Fig. 5 Example illustration

- ▷ The status display appears.
- ▷ The appliance cools to the temperature set at the factory.
- ▷ The appliance starts in demo mode (status display with DEMO appears): If the appliance starts in demo mode, you can deactivate demo mode within the next 5 minutes. (see Demo mode)

#### More information:

- When you start up the appliance, the **status light** (status display) is deactivated by default. Activate the status light. (see Status light (status display)\*) \*
- Start the IceMaker for the first time. (see 4.2 Starting the IceMaker for the first time)
- Start the SmartDevice for the first time. (see 1.3 Smart-Device) and (see WiFi)

#### Note

The manufacturer recommends:

- ▶ **Store frozen foods** at -18 °C or colder.
- ▶ Observe the notes on storing food. (see 5.1 Information regarding storage)

#### Note

Accessories can be purchased from the Liebherr-Hausgeräte store at [home.liebherr.com/shop/de/deu/zubehor.html](http://home.liebherr.com/shop/de/deu/zubehor.html).

### 4.2 Starting the IceMaker for the first time

If your appliance is equipped with IceMaker, you must clean the IceMaker **before using it for the first time**.

Make sure that the following requirements are fulfilled:

- The water supply has been connected. See Installation Guide or mounting instructions.
- The appliance is properly connected.
- ▶ Clean the IceMaker. (see 9.3.5 Cleaning the IceMaker)

## 5 Storage

### 5.1 Information regarding storage



#### WARNING

Risk of fire

- ▶ Do not use any electrical appliances in the food area of the appliance unless recommended by the manufacturer.

# Storage

## Note

The energy consumption increases and the cooling power goes down if ventilation is not sufficient.

- ▶ Always keep air slots clear.

Observe the following specifications for storage:

- Package food properly.
- Package raw meat or fish in clean, closed containers. This will prevent meat or fish from touching or dripping onto other food.
- Leave space between goods to ensure good air circulation.
- Store food according to the instructions on the packaging.
- Always observe the best-before date indicated on the packaging.

## Note

Failure to follow these guidelines can lead to foodstuffs spoiling.

## 5.2 Freezer compartment

Here, a dry, frosty storage climate is created at -18 °C. The frosty storage climate is suitable for storing frozen food for several months, for making ice cubes or freezing fresh food.

### 5.2.1 Freezing food

#### Freezing quantity

The maximum amount of fresh food that you can freeze within 24 hours is specified on the type plate (see 10.5 Model plate) under "Freezing capacity ... kg/24h".

To ensure that food quickly freezes through, adhere to the following quantities per package:

- Fruit and vegetables up to 1 kg
- Meat up to 2.5 kg

#### Freezing food using SuperFrost

Depending on the quantity to be frozen, you can activate SuperFrost before freezing in order to achieve lower freezing temperatures. (see SuperFrost)

- ▶ Activate SuperFrost if the amount of food you have to freeze is more than approx. 2 kg.

The time at which you activate SuperFrost depends on the amount of food you have to freeze:

Freezing quantity	Time at which you should activate SuperFrost
Small amount of food to freeze	Activate SuperFrost about 6 hours before freezing. You can place the food in the freezer as soon as the appliance automatically deactivates SuperFrost.
Maximum amount of food to freeze	Activate SuperFrost about 24 hours before freezing. You can place the food in the freezer as soon as the appliance automatically deactivates SuperFrost.

## Arranging your food properly



### CAUTION

Risk of injury from broken glass!

Bottles and cans with beverages can burst during freezing. This applies in particular to carbonated beverages.

- ▶ Only freeze bottles and cans with beverages if you have activated the BottleTimer function in the SmartDevice app.

Freezing quantity	Arranging your food properly
Small amount of food to freeze	Place packaged food in the top drawer. If possible, place groceries at the back of the drawer near the rear wall.
Maximum amount of food to freeze	Distribute packaged groceries throughout all drawers, but only place frozen food in the bottom drawer. If possible, place groceries at the back of the drawer near the rear wall.

### 5.2.2 Defrosting food



### WARNING

Risk of food poisoning!

- ▶ Do not re-freeze thawed food.
- ▶ Use defrosted foodstuff as soon as possible.

You can defrost food in several ways:

- In the fridge compartment
- In the microwave
- In the oven/fan-assisted oven
- At room temperature
- ▶ Take out only as much food as necessary.

### 5.2.3 Freezer tray

You can freeze berries, herbs, vegetables and other small frozen food in the freezer tray without it all freezing together. The frozen food is less likely to get squashed and subsequent portioning is easier.

In addition, you can store the cold storage accumulators in the freezer tray to save space.

- ▶ Distribute food on the freezer tray without packaging and well spaced out.

## 5.3 Storage times

Refer to the specified storage times as a guide.

In the case of foods with a minimum shelf life, the date indicated on the packaging still applies.

Recommended storage period for various types of food		
Ice cream	at -18 °C	2 to 6 months
Sausages, ham	at -18 °C	2 to 3 months
Bread, baked goods	at -18 °C	2 to 6 months
Game, pork	at -18 °C	6 to 9 months
Fatty fish	at -18 °C	2 to 6 months
Lean fish	at -18 °C	6 to 8 months
Cheese	at -18 °C	2 to 6 months
Poultry, beef	at -18 °C	6 to 12 months



Recommended storage period for various types of food		
Vegetables, fruit	at -18 °C	6 to 12 months

## 6 Saving energy

- Pay attention to good ventilation. Do not cover ventilation holes or grids.
- Always keep the fan air slits clear.
- Do not place the appliance in direct sunlight or near radiators or similar sources of heat.
- If the appliance is placed directly next to an oven, the energy consumption may increase slightly. This is dependent on the service life and usage intensity of the oven.
- Energy consumption depends on the installation conditions, e.g. the ambient temperature (see 1.4 Appliance range of use) . A warmer ambient temperature can increase the energy consumption.
- Open the appliance for as short a time as possible.
- The lower the temperature is set the higher the energy consumption.
- Keep all food properly packed and covered. This prevents frost from forming.
- Inserting warm food: allow to cool down to room temperature first.

Dust deposits increase energy consumption:

- For refrigerators with heat exchangers dust the metal grid on the back of the appliance once a year.



## 7 Controls

### 7.1 Controls and displays

#### 7.1.1 Status display

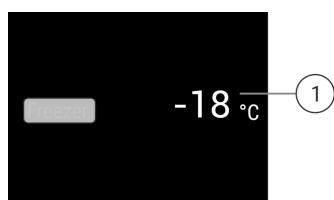

Fig. 6

**(1)** Temperature display

The Status display shows the set temperatures and is the home display. From there, you can navigate to the options and settings.

#### 7.1.2 Display symbols

Display symbols provide information on the current appliance status:

Symbol	Appliance status
	<b>Standby</b> The appliance or temperature zone is switched off.
	<b>Flashing number</b> Appliance is working. Temperature flashes until the set temperature is reached.

Symbol	Appliance status
	<b>Flashing symbol</b> Appliance is working. Setting is made.

## 7.2 Appliance functions

### 7.2.1 Notes on the appliance functions

The appliance functions are set at the factory so that your appliance is fully functional.

Before you alter, activate or deactivate the device functions, make sure that the following requirements are met:

- You have read and understood the descriptions of how the display works. (see 3 Functionality of the Touch & Swipe display)
- You have familiarised yourself with the operating and display elements of your appliance.

### Switching the appliance off and on

Use this function to switch the entire appliance off and on.

#### Switching off the appliance

When you switch the appliance off, then the previously saved settings are saved.

Make sure that the following requirements are fulfilled:

- Handling instructions (see 11 Shutting down) are carried out.



Fig. 7

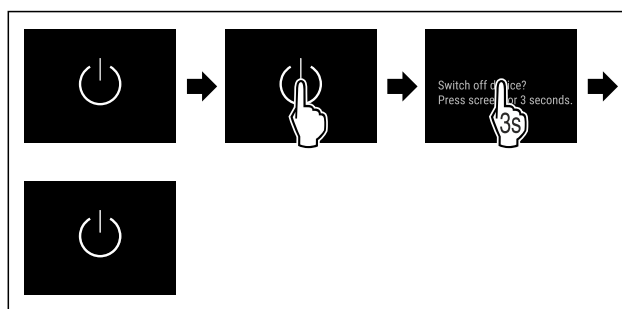

Fig. 8

- ▶ Carry out action steps according to the illustration.
- ▷ Appliance is switched off.
- ▷ The standby symbol appears in the display.
- ▷ Display turns black.

#### Switching on the appliance

- ▶ If the display is in sleep mode:
- ▶ Briefly touch the display.

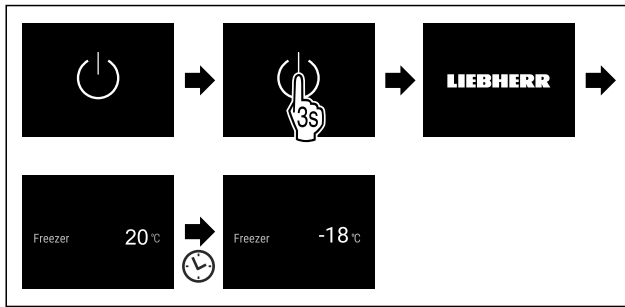

Fig. 9 Example illustration

- ▶ Carry out action steps according to the illustration. When the appliance starts in demo mode:
- ▶ Deactivating demo mode. (see Deactivating demo mode)
- ▶ The appliance is switched on.
- ▷ Previous settings are restored.
- ▷ The appliance cools to the target temperature set.



## WiFi

Use this function to connect your appliance to WiFi. You can then operate it via the SmartDevice app on a mobile device. You can also use this function to disconnect or reset the WiFi connection.

More information on the SmartDevice: (see 1.3 SmartDevice)

### Note

The SmartDevice function is not available in the following countries: Russia, Belarus, Kazakhstan.

### Establishing the WiFi connection for the first time

Make sure that the following requirements are fulfilled:

- You have installed the SmartDevice app (see [apps.home.liebherr.com](https://apps.home.liebherr.com)).
- Registration in the SmartDevice app is completed.



Fig. 10

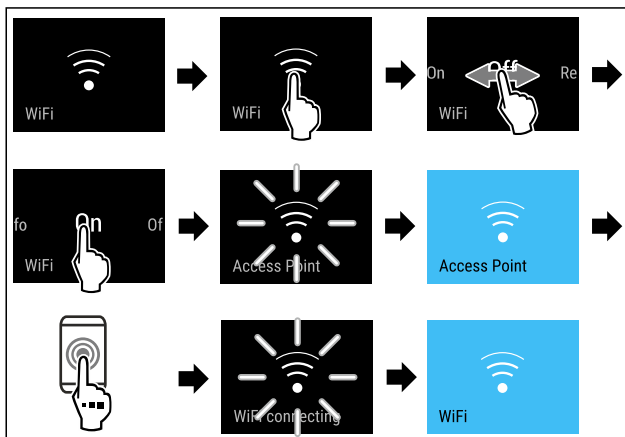

Fig. 11

- ▶ Carry out action steps according to the illustration.
- ▷ Connection is established.

### Disconnecting from the WiFi

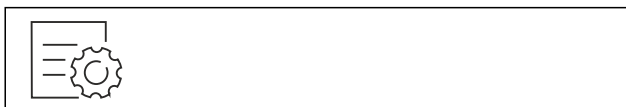

Fig. 12

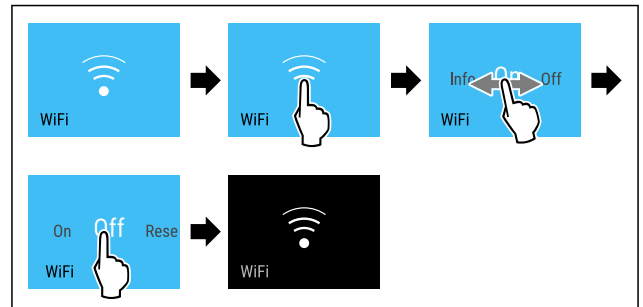

Fig. 13

- ▶ Carry out action steps according to the illustration.
- ▷ There is no connection.

### Resetting the WiFi connection



Fig. 14

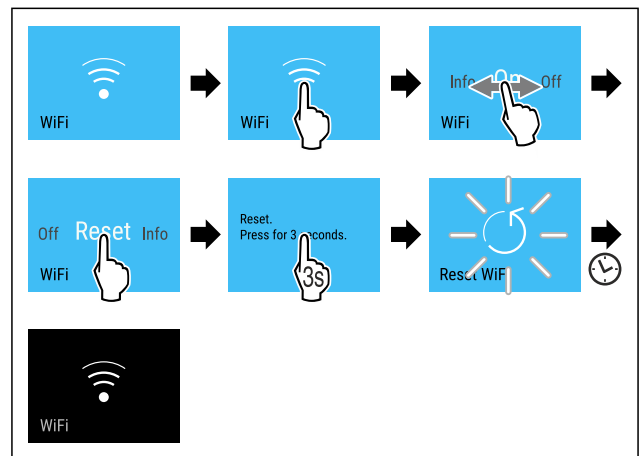

Fig. 15

- ▶ Carry out action steps according to the illustration.
- ▷ WiFi connection and other WiFi settings are reset to factory settings.

### Showing information about the WiFi connection



Fig. 16

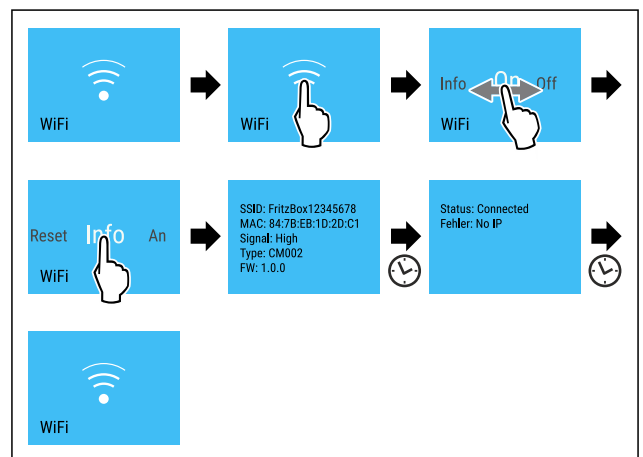

Fig. 17

- ▶ Carry out action steps according to the illustration.

## **-18°C** Temperature

Use this function to set the temperature.

The temperature depends on the following factors:

- Frequency of door opening
- Duration of door opening
- Room temperature of the installation site
- Type, temperature and quantity of food

Freezer compartment	Factory-set temperature	Recommended setting
<b>-18°C</b>	-18 °C	-18 °C

### Setting the temperature

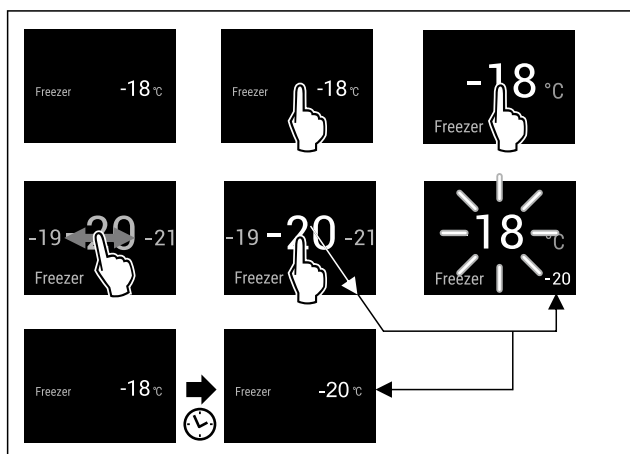

Fig. 18 Example illustration

- ▶ Carry out action steps according to the illustration.
- ▷ Temperature is set.

## **°C/°F** Temperature unit

Use this function to set the temperature unit. You can set degrees Celsius or degrees Fahrenheit as the temperature unit.

### Setting the temperature unit



Fig. 19

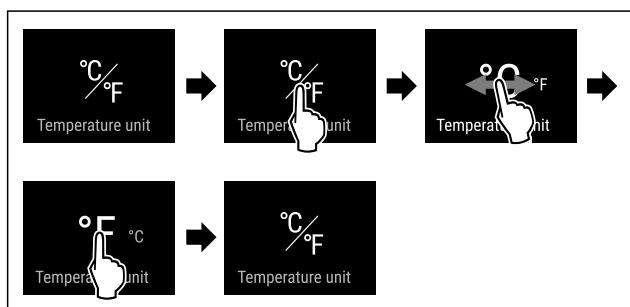

Fig. 20 Example illustration: Switch from degrees Celsius to degrees Fahrenheit.

- ▶ Carry out action steps according to the illustration.
- ▷ The temperature unit is set.

## **\*\*** SuperFrost

You can use this function to activate or deactivate SuperFrost. If SuperFrost is activated, then the appliance increases the freezing capacity. It allows you to achieve lower freezing temperatures.

Application:

- Quickly freeze fresh food through to the core. This ensures that the nutrition, appearance and taste of frozen food is maintained.
- Increase the cold reserve in stored frozen food before defrosting the appliance.

If the function is active, the appliance operates at higher power. As a result, the appliance's operating noise may be temporarily louder and energy consumption will increase.

### Activating SuperFrost

Make sure that the following requirements are fulfilled:

- Freezing quantity and time for activation of SuperFrost are taken into account. (see Freezing food using SuperFrost)

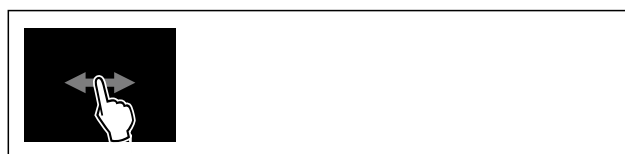

Fig. 21

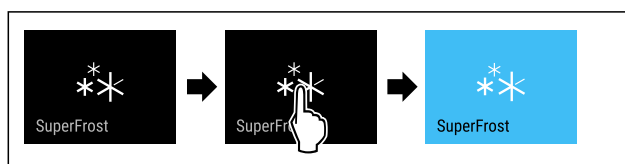

Fig. 22

- ▶ Carry out action steps according to the illustration.
- or-
- ▶ Activate with the SmartDevice app.
- ▷ SuperFrost is activated.
- ▷ The temperature display turns blue.

### Deactivating SuperFrost

SuperFrost is automatically deactivated after 56 to 72 hours depending on the quantity of the food inserted. However, you can also deactivate SuperFrost manually at any time:



Fig. 23



Fig. 24

- ▶ Carry out action steps according to the illustration.
- or-
- ▶ Deactivate with the SmartDevice app.
- ▷ SuperFrost is deactivated.
- ▷ The appliance continues to run in normal mode.
- ▷ The appliance cools to the temperature set previously.

# Controls



## Start defrosting cycle

Use this function to start the automatic defrosting cycle manually if it does not start automatically in the event of a fault.

### Starting defrosting cycle



Fig. 25

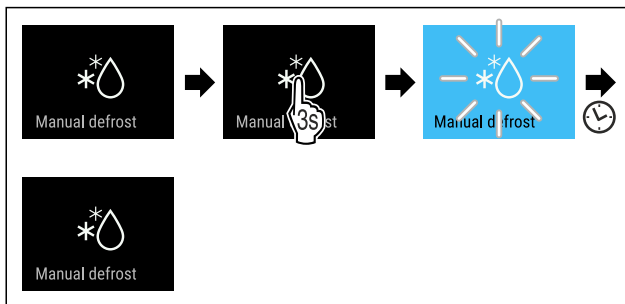

Fig. 26

- ▶ Carry out action steps according to the illustration.
- ▷ Defrosting cycle has started: Icon flashes until defrosting cycle is automatically completed.
- ▷ When defrosting cycle is finished: The device continues to run in normal mode.

### Cancelling defrosting cycle

The defrosting cycle will be stopped automatically. However, you can also cancel the defrosting cycle at any time during the defrosting process:

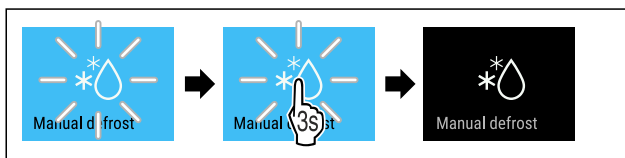

Fig. 27

- ▶ Carry out action steps according to the illustration.
- ▷ Defrosting cycle is cancelled.
- ▷ The device continues to run in normal mode.



## PartyMode

You can use this function to activate or deactivate PartyMode. PartyMode activates various functions that are useful for a party.

PartyMode activates the following functions:

- SuperFrost
- IceMaker with MaxIce (see IceMaker / MaxIce)

You can adjust all listed functions individually and flexibly. When you deactivate PartyMode, all changes are discarded.

If the function is active, the device operates at higher power. As a result, the device's operating noise may be temporarily louder and energy consumption will increase.

### Activating PartyMode

Make sure that the following requirements are fulfilled:

- The IceMaker has been started. (see 4.2 Starting the IceMaker for the first time)



Fig. 28

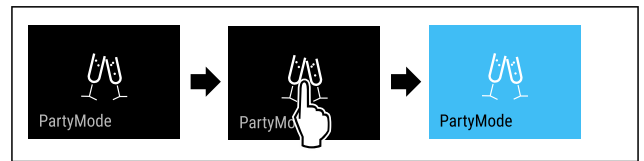

Fig. 29

- ▶ Carry out action steps according to the illustration.
- ▷ PartyMode and the associated functions are activated.
- ▷ The temperature display turns blue.
- ▷ The current temperature flashes until the target temperature is reached.

### Deactivating PartyMode

The PartyMode is automatically deactivated after 24 seconds. However, you can also deactivate PartyMode manually at any time:



Fig. 30

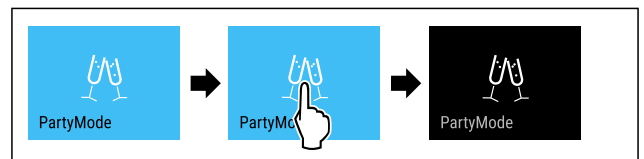

Fig. 31

- ▶ Carry out action steps according to the illustration.
- ▷ PartyMode is deactivated.
- ▷ The appliance cools to the temperature set previously: The current temperature flashes until the target temperature is reached.



## SabbathMode

You can use this function to activate or deactivate SabbathMode. If you activate this function, some electronic functions are switched off. As a result, your device meets the religious requirements for Jewish holidays such as Sabbath and complies with STAR-K Kosher certification.

Device status when SabbathMode is active
The status display shows SabbathMode permanently.
All functions on the display are locked except for the <b>Deactivate SabbathMode function</b> .
Active functions remain active.
The display remains bright when you close the door.
The interior lighting is deactivated.
Reminders are not implemented. The set time interval stops.
Reminders and warnings are not displayed.
There is no door alarm.

Device status when SabbathMode is active
There is no temperature alarm.
The IceMaker is switched off.
The defrosting cycle operates only for the specified time, without considering the device consumption.
After a power failure, the device returns to SabbathMode.

### Device status

#### Note

This appliance has certification from the "Institute for Science and Halacha". ([www.machonhalacha.co.il](http://www.machonhalacha.co.il))

You can find a list of STAR-K-certified appliances at [www.star-k.org/appliances](http://www.star-k.org/appliances).

### Activating SabbathMode



#### WARNING

Danger of food poisoning from spoiled food!

If you have SabbathMode activated and a power failure occurs, no message appears in the status display about the power failure. Once the power is restored, the appliance continues to operate in SabbathMode. The power failure may mean that food spoils and the consumption of this food could lead to food poisoning.

After a power failure:

- ▶ Do not consume food that was frozen and has thawed out.

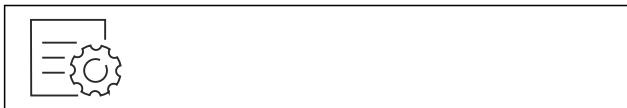

Fig. 32

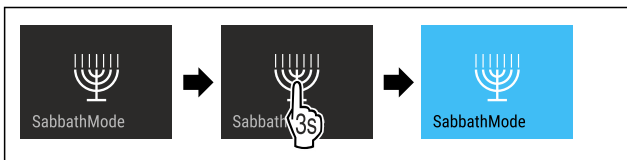

Fig. 33

- ▶ Carry out action steps according to the illustration.
- ▷ SabbathMode is activated.
- ▷ The status display shows SabbathMode permanently.

### Deactivating SabbathMode

The SabbathMode is automatically deactivated after 80 hours. However, you can also deactivate SabbathMode manually at any time:

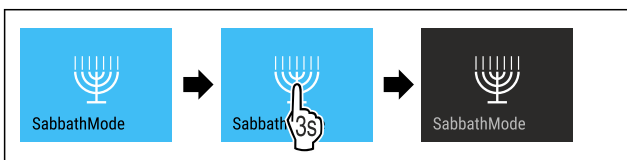

Fig. 34

- ▶ Carry out action steps according to the illustration.
- ▷ SabbathMode is deactivated.



### EnergySaver

You can use this function to activate or deactivate Energy saving mode. If energy saving mode is activated, the energy consumption decreases and the temperature in the device increases. The food remains fresh, but the shelf life is shortened.

Temperature zone	Recommended setting (see Setting the temperature)	Temperature with active EnergySaver
-18 °C	-18 °C	-16 °C

### Temperatures

### Activating EnergySaver



Fig. 35

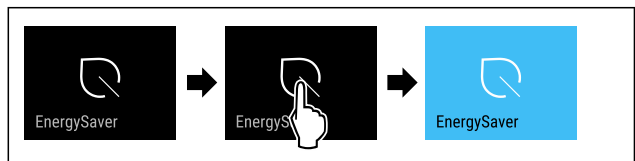

Fig. 36

- ▶ Carry out action steps according to the illustration.
- ▷ Energy saving mode is activated.

### Deactivating EnergySaver



Fig. 37

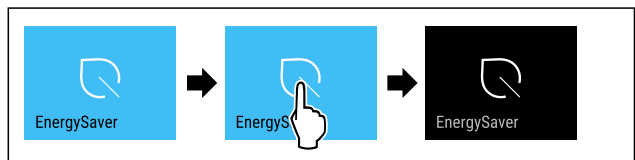

Fig. 38

- ▶ Carry out action steps according to the illustration.
- ▷ Energy saving mode is deactivated.



### IceMaker / MaxIce

You can activate or deactivate ice cube production with the IceMaker function. Use the MaxIce function to increase the number of ice cubes in the IceMaker.

More information on the number of ice cubes:	(see 10.1 Technical specifications)
Further information on the IceMaker water supply:	(see IceMaker water supply)
More information on cleaning the lines of the IceMaker:	(see TubeClean)

If the function is active, the device operates at higher power. As a result, the device's operating noise may be temporarily louder and energy consumption will increase.

### Activating IceMaker

Make sure that the following requirements are fulfilled:

- The water supply is established at the fixed water connection. See installation instructions.
- IceMaker is put into operation. (see 8.4 IceMaker)

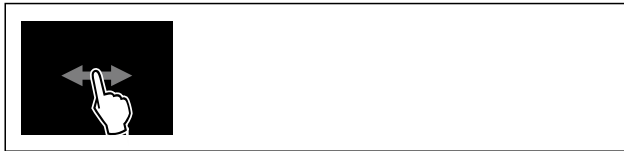

Fig. 39

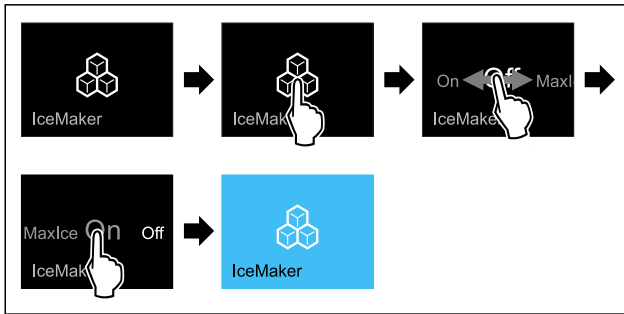

Fig. 40

- ▶ Carry out action steps according to the illustration.
- or-
- ▶ Activate with the SmartDevice app.
- ▷ IceMaker is activated. It can take up to 24 hours for the IceMaker to produce the first ice cubes.

### Activating the IceMaker with MaxIce

If you have not activated the IceMaker function before, make sure that the following requirements are met:

- The water supply is established at the fixed water connection. See installation instructions.
- IceMaker is put into operation. (see 8.4 IceMaker)



Fig. 41

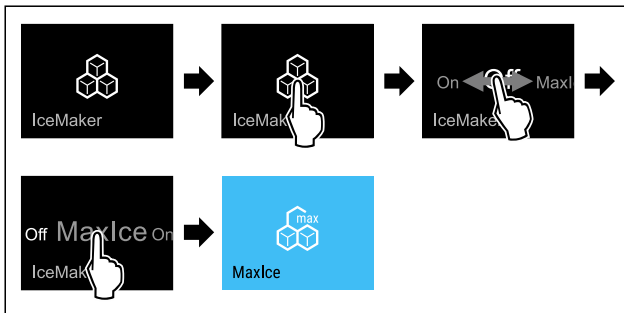

Fig. 42

- ▶ Carry out action steps according to the illustration.
- or-
- ▶ Activate with the SmartDevice app.
- ▷ The IceMaker is activated with MaxIce.

### Changing between the IceMaker and MaxIce

If you have activated the IceMaker and would like to change to MaxIce:



Fig. 43

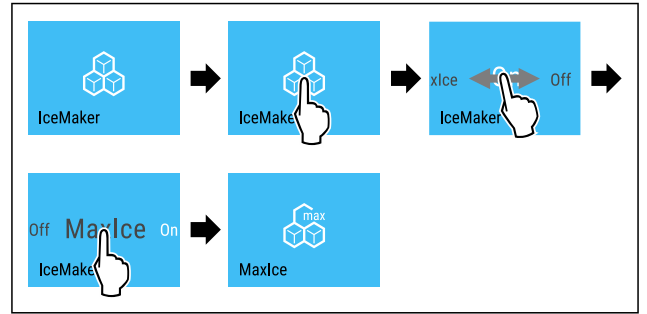

Fig. 44

- ▶ Carry out action steps according to the illustration.
- ▷ The IceMaker is activated with MaxIce.

If you have activated MaxIce and would like to change to the IceMaker:



Fig. 45

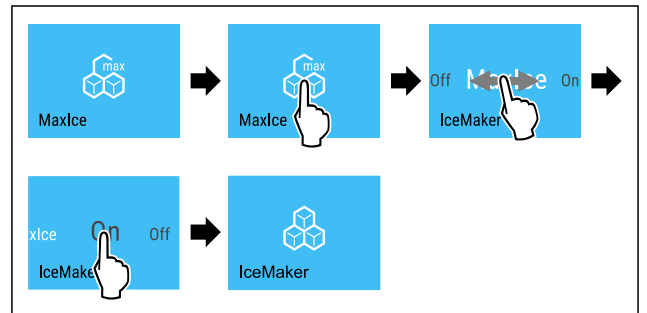

Fig. 46

- ▶ Carry out action steps according to the illustration.
- ▷ IceMaker is activated.
- ▷ MaxIce is deactivated.

### Deactivating the IceMaker / MaxIce



Fig. 47

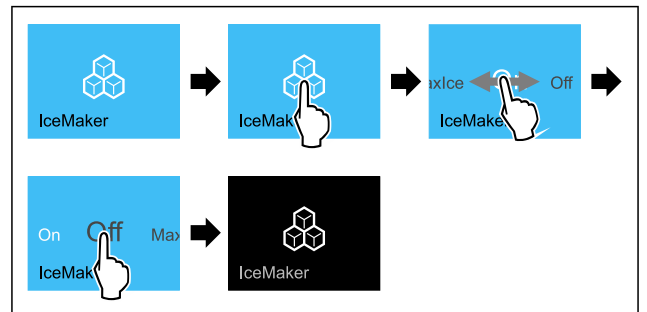

Fig. 48 Example illustration of the active IceMaker function

- ▶ Carry out action steps according to the illustration.

-or-

- ▶ Deactivate with the SmartDevice app.
- ▷ IceMaker and MaxIce are deactivated.
- ▷ If ice cubes are currently being made, the system completes the process.
- ▷ The IceMaker goes off automatically.

5

## IceMaker water supply

Use this function to set the IceMaker water supply. The IceMaker water supply regulates the amount of water supplied. The IceMaker water supply can be changed if the water supply does not match the water pressure and the ice cube size dispensed.

The IceMaker water supply is pre-set to value 5 as delivered. A value from 1 (smallest inflow volume) to 8 (largest inflow volume) can be selected.

### Setting the IceMaker water supply

Make sure that the following requirements are fulfilled:

- The IceMaker has been started. (see 4.2 Starting the IceMaker for the first time)
- IceMaker is activated. (see IceMaker / MaxIce )



Fig. 49

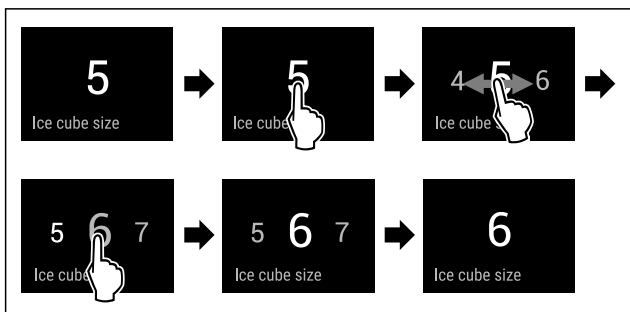

Fig. 50 Example illustration: Switch from value 5 to value 6.

- ▶ Carry out action steps according to the illustration.
- ▷ IceMaker water supply is set.

## TubeClean

You can use this function to activate or deactivate TubeClean. If TubeClean is activated, it cleans the IceMaker lines.

### Activating TubeClean

Make sure that the following requirements are fulfilled:

- IceMaker cleaning is prepared. (see 9.3.5 Cleaning the IceMaker)
  - Empty container with a capacity of 1.5 l and with a maximum height of 10 cm is ready.
- ▶ Place the container in the drawer under the IceMaker.

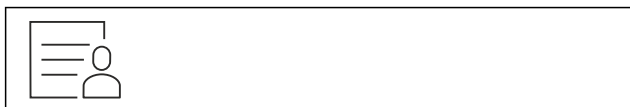

Fig. 51

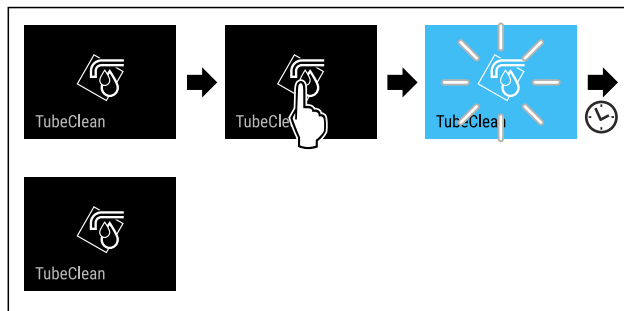

Fig. 52

- ▶ Carry out action steps according to the illustration.
- ▷ TubeClean is activated.
- ▷ The cleaning process has started: Icon flashes until the cleaning process is automatically completed after 60 minutes.
- ▷ When the cleaning process is complete: The device continues to run in normal mode.

### Deactivating TubeClean

TubeClean is automatically ended after 60 minutes. However, TubeClean can also be deactivated at any time during the cleaning process:

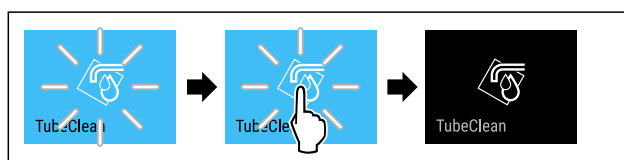

Fig. 53

- ▶ Carry out action steps according to the illustration.
- ▷ TubeClean is deactivated: Cleaning process is aborted.
- ▷ The device continues to run in normal mode.

## Status light (status display)\*

This function activates and deactivates the status light (status display). When you start up the appliance, the status light is deactivated by default. After you have activated the status light, the colour of the light indicates the status of the appliance when the door is closed. When the door is open, the status light is inactive.

Status light	Status of the appliance
Blue light	The appliance is working perfectly.
Red, pulsating light Audible signal	Power failure (see 7.3.1 Overview of warnings) Temperature alarm (see 7.3.1 Overview of warnings) Error (see 7.3.1 Overview of warnings)

Meaning of the colour of the status light

### Activating the status light



Fig. 54

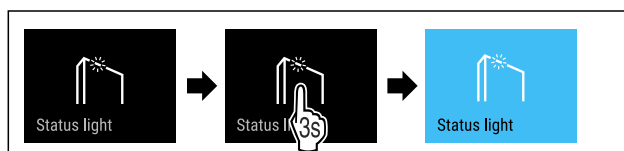

Fig. 55

# Controls

- ▶ Carry out action steps according to the illustration.

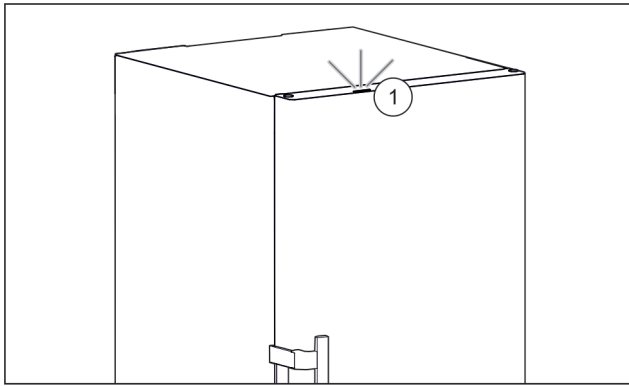

Fig. 56 Active status light when the door is closed

- ▷ Status light Fig. 56 (1) is activated.
- ▷ The status light lights up blue or red when the door is closed.

## Deactivating the status light



Fig. 57

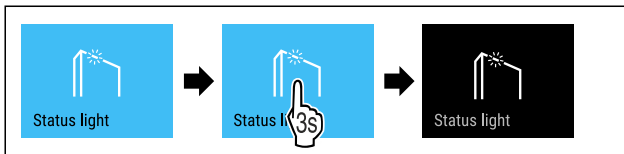

Fig. 58

- ▶ Carry out action steps according to the illustration.
- ▷ Status light is deactivated.

## Display brightness

Use this function to set the display brightness in stages.

You can select the following brightness levels:

- 40 %
- 60 %
- 80 %
- 100 % (pre-setting)

## Setting the brightness

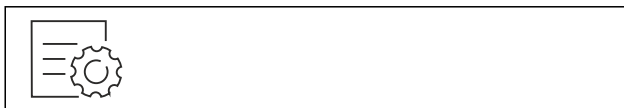

Fig. 59

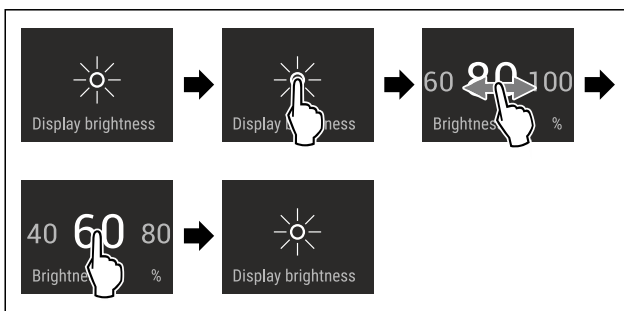

Fig. 60 Example illustration: Switch from 80 % to 60 %.

- ▶ Carry out action steps according to the illustration.
- ▷ The brightness is set.

## Door alarm

Use this function to activate or deactivate the door alarm. The door alarm sounds if the door is open for too long. The door alarm is activated on delivery. You can set how long the door may be open before the door alarm sounds.

The following values can be set:

- 1 minute
- 2 minutes
- 3 minutes
- Off

## Setting the door alarm



Fig. 61

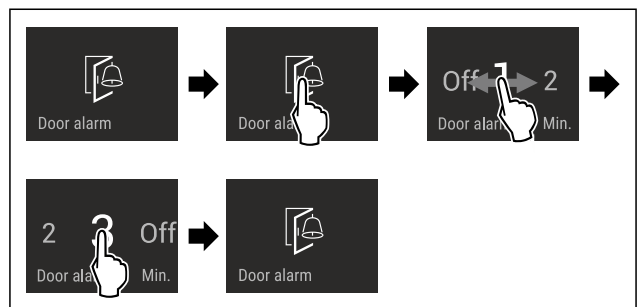

Fig. 62 Example illustration: Change door alarm from 1 minute to 3 minutes.

- ▶ Carry out action steps according to the illustration.
- ▷ The door alarm is set.

## Deactivating the door alarm

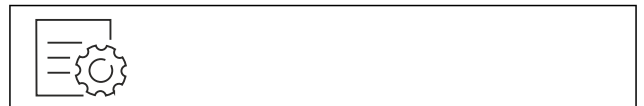

Fig. 64

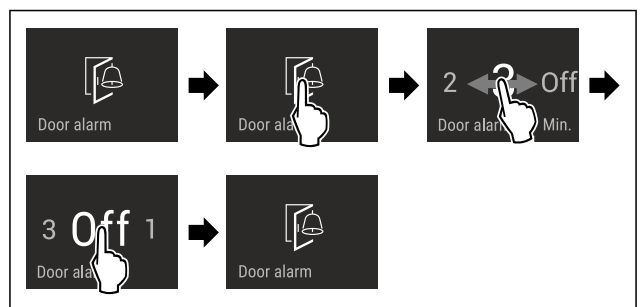

Fig. 65

- ▶ Carry out action steps according to the illustration.
- ▷ The door alarm is deactivated.

## Input lock

You can use this function to activate or deactivate the input lock. The input lock prevents the appliance being operated accidentally, e.g. by children.

Application:

- Avoid unintentional modification of functions.
- Avoid unintentional switching off of the device.
- Avoid unintentional temperature setting.



## Activating the input lock

If you activate the input lock, you can continue to navigate in the menus but you cannot select or change other functions.



Fig. 66

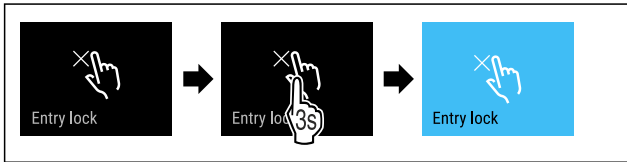

Fig. 67

- ▶ Carry out action steps according to the illustration.
- ▷ Input lock is activated.

## Deactivating the input lock

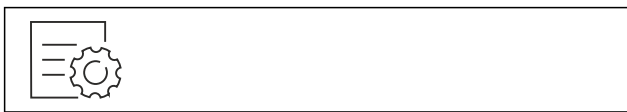

Fig. 68

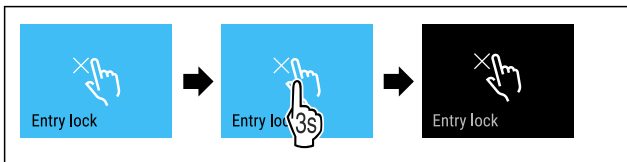

Fig. 69

- ▶ Carry out action steps according to the illustration.
- ▷ Input lock is deactivated.

## Language

Use this function to set the display language.

You can select the following languages:

- Deutsch
- English
- Français
- Español
- Italiano
- Nederlands
- Čeština
- Polski
- Português
- Bulgarian
- Русский
- 温度单位

## Setting the language

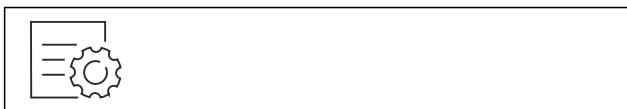

Fig. 70

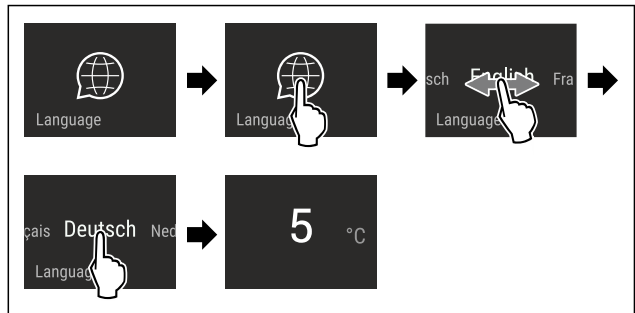

Fig. 71 Example illustration depending on the language and temperature

- ▶ Carry out action steps according to the illustration.
- ▷ The language is set.
- ▷ The display returns to the status display.



## Device information

Use this function to indicate the model name, index, serial number and service number of your device. You will need the device information when you contact customer service. (see 10.4 Customer Service)

This function also opens the Advanced menu. (see 3 Functionality of the Touch & Swipe display)

## Indicating the device information



Fig. 72



Fig. 73

- ▶ Carry out action steps according to the illustration.
- ▷ Display indicates device information.



## Software

Use this function to indicate the software version of your device.

## Indicating the software version



Fig. 74

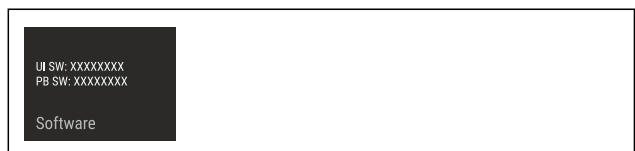

Fig. 75

- ▶ Carry out action steps according to the illustration.
- ▷ Display indicates software version.

# Controls



## Reminder

Use this function to activate or deactivate the reminders. The function is activated on delivery.

### Activating the reminder



Fig. 76

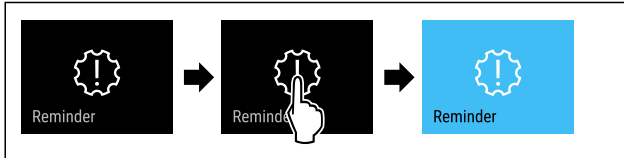

Fig. 77

- ▶ Carry out action steps according to the illustration.
- ▷ Reminder is activated.

### Deactivating the reminder



Fig. 78

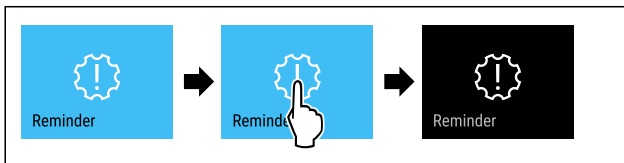

Fig. 79

- ▶ Carry out action steps according to the illustration.
- ▷ Reminder is deactivated.



## Demo mode

Demo mode is a special feature for dealers who want to demonstrate appliance features. If you activate demo mode, all refrigeration functions are deactivated.

If you switch on your appliance and “Demo” appears in the status display, then demo mode is already activated.

If you activate and then deactivate demo mode, the appliance will be reset to factory defaults. (see Resetting to factory settings)

### Activating demo mode



Fig. 80

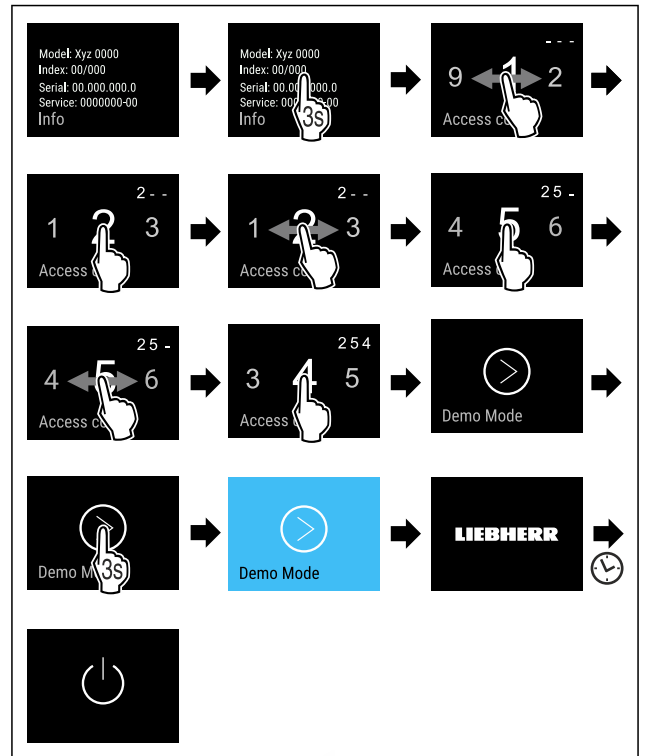

Fig. 81

- ▶ Carry out action steps according to the illustration.
- ▷ Demo mode is activated.
- ▷ Appliance is switched off.
- ▶ Switch on the appliance. (see 4.1 Switching on appliance (first use))
- ▷ “DEMO” appears in the status display.

### Deactivating demo mode

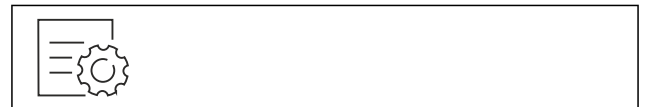

Fig. 82

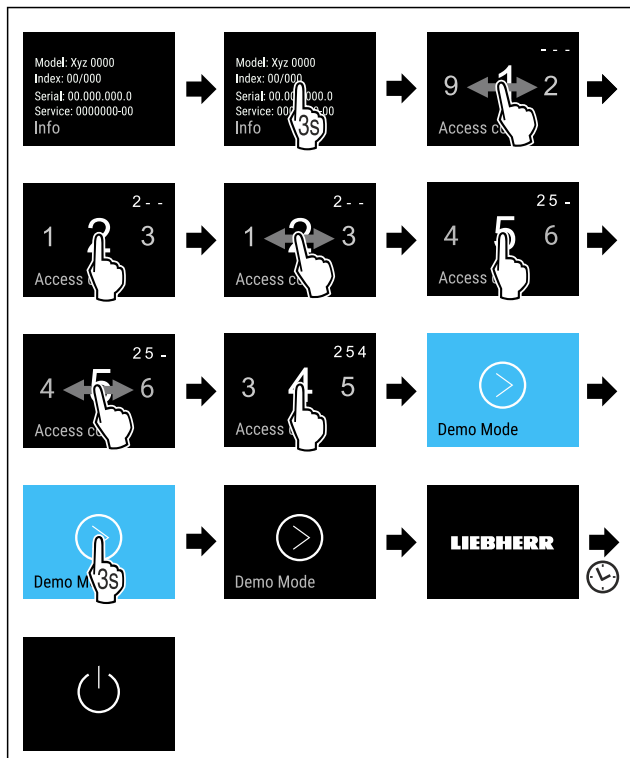

Fig. 83

- ▶ Carry out action steps according to the illustration.
- ▷ Demo mode is deactivated.
- ▷ Appliance is switched off.
- ▶ Switch on the appliance. (see 4.1 Switching on appliance (first use))
- ▷ Appliance is reset to factory settings.

## Resetting to factory settings

Use this function to reset all settings to factory defaults. All settings you have made so far are reset to their original settings.

### Performing a reset



Fig. 84

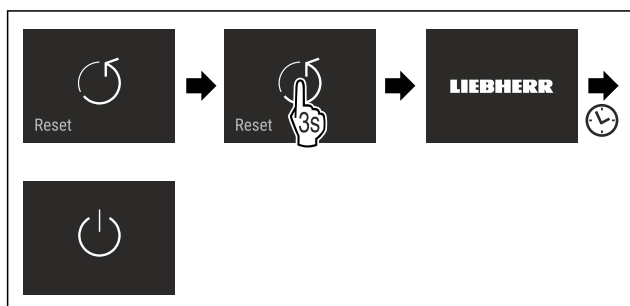

Fig. 85

- ▶ Carry out action steps according to the illustration.
- ▷ Device is reset.
- ▷ Device is switched off.
- ▶ Restart the device. (see 4.1 Switching on appliance (first use))

## 7.3 Messages



There are two categories of messages:

Category	Importance
Warning	Warnings appear in the event of a door alarm or malfunction. Simple warnings can be cancelled by yourself. In the event of serious malfunctions, you must contact customer service. (see 10.4 Customer Service)
Reminder	Reminders remind you of general processes. You can carry out these operations to end the message.

### 7.3.1 Overview of warnings

Behaviour of the appliance in the event of warnings:

- Warning appears in red on the display.
- The alarm tone sounds at an ever-increasing volume.
- The interior lighting pulsates for some warnings.

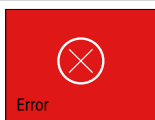
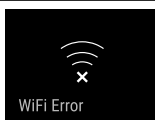
Message	Cause	Exit the message
 Close the door. <b>Door alarm</b>	The message appears if the door is open for too long.	Carry out action steps (see Door alarm) .
 Power failure <b>Power outage alarm</b>	The message appears if the freezing temperature has risen due to a power failure.	Carry out action steps (see Power outage alarm) .
 Temperature alarm <b>Temperature alarm</b>	The message appears if the freezing temperature does not correspond to the set temperature.	Carry out action steps (see Temperature alarm) .
 Error <b>Error</b>	The message appears if there is an appliance error. A component of the appliance has a fault.	Carry out action steps (see Error) .
 WiFi Error <b>WLAN error</b>	The message appears if the appliance could not be connected to the WLAN. (see Establishing the WiFi connection for the first time)	Carry out action steps (see WLAN error) .

### 7.3.2 Ending warnings

#### Door alarm

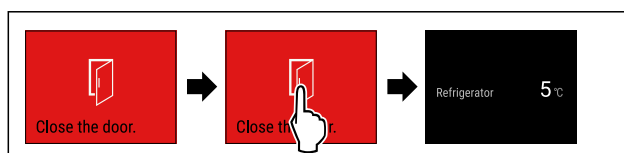

Fig. 86 Example illustration

# Controls

► Carry out action steps according to the illustration.

-or-

► Close the door.

▷ The display returns to the status indicator.

You can set how long the door may be open before the door alarm sounds. (see Setting the door alarm)

## Power outage alarm

When the power failure has ended, the appliance cools down to the previously set target temperature.

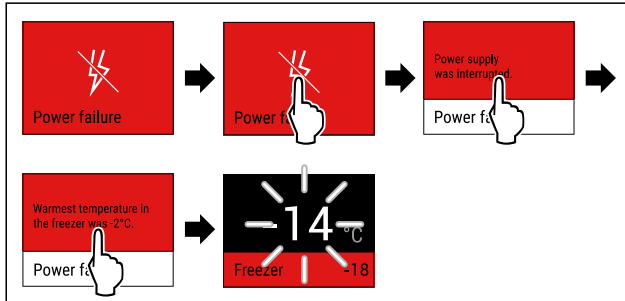

Fig. 87 Example illustration

- Briefly touch the display.
- ▷ Display shows information about the warning.
- Briefly touch the display.
- ▷ Warmest freezing temperature is displayed.
- ▷ If the freezing temperature was below -9 °C: Food can still be consumed.
- ▷ If the freezing temperature has risen above -9 °C:
- Check the food.
- Briefly touch the display.
- ▷ The display returns to the status indicator: Current temperature and target temperature are displayed.

## Temperature alarm

Temperature differences can be caused by:

- You have put in warm, fresh food.
- Too much warm air has got in while you were sorting out the freezer or removing items.
- There has been a longer power failure.
- The appliance is faulty.
- Eliminate causes.
- ▷ The appliance cools to the target temperature set previously.

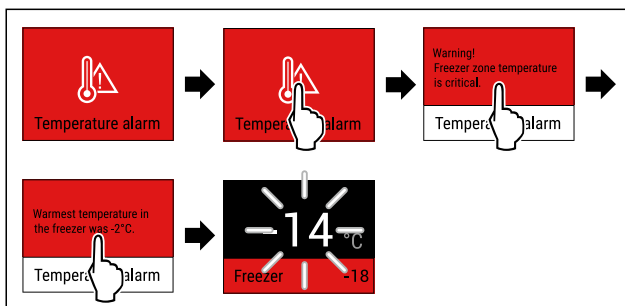

Fig. 88 Example illustration

- Briefly touch the display.
- ▷ Display shows information about the warning.
- Briefly touch the display.
- ▷ Warmest freezing temperature is displayed.
- ▷ If the freezing temperature was below -9 °C: Food can still be consumed.
- ▷ If the freezing temperature has risen above -9 °C:
- Check the food.
- Briefly touch the display.
- ▷ The display returns to the status indicator: Current temperature and target temperature are displayed.

## Error

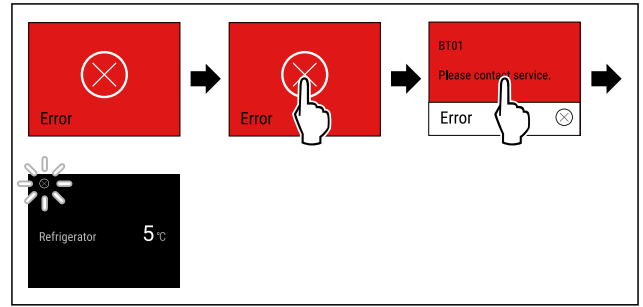

Fig. 89 Example illustration

- Briefly touch the display.
- ▷ Error code is displayed.
- Note the error code.
- Briefly touch the display.
- ▷ The display returns to the status indicator.
- Contact Customer Service. (see 10.4 Customer Service)

## WLAN error

- Check WLAN connection.
- Reconnect the appliance to the WLAN. (see WiFi)

## 7.3.3 Overview of reminders

Behaviour of the appliance during reminders:

- Reminder appears yellow on the display.
- Alarm tone sounds.
- The interior lighting pulsates for some reminders.

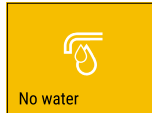
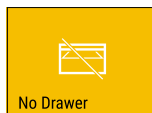
Message	Cause	Exit the message
 <b>No water</b> <b>Check the water connection</b>	The message appears if the IceMaker is activated but the IceMaker is not being supplied with water via the fixed water connection.	Carry out action steps (see Check the water connection).
 <b>No Drawer</b> <b>Insert the IceMaker drawer</b>	The message appears if the IceMaker is activated but the IceMaker drawer is open.	Carry out action steps (see Insert the IceMaker drawer).

## 7.3.4 Ending reminders

### Check the water connection

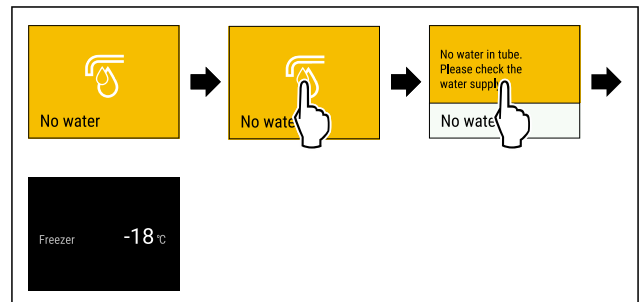

Fig. 90 Example illustration

- Briefly touch the display
- ▷ Display shows reminder information.
- Briefly touch the display
- Check the water connection.

-or-

- ▶ Deactivate IceMaker. (see Deactivating the IceMaker / MaxIce )

If water connection is checked and IceMaker is activated:

- ▶ Clean the IceMaker. (see 9.3.5 Cleaning the IceMaker)
- ▷ IceMaker produces ice cubes.

## Insert the IceMaker drawer

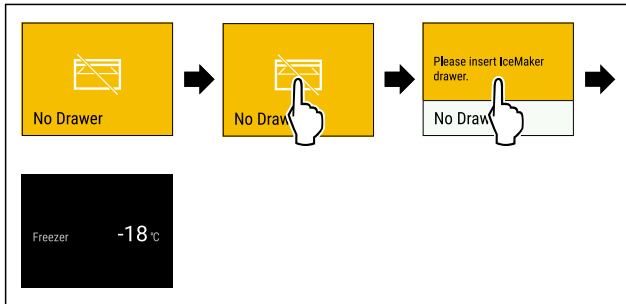

Fig. 91 Example illustration

- ▶ Briefly touch the display.
- ▷ Display shows reminder information.
- ▶ Briefly touch the display.
- ▶ Insert the IceMaker drawer.

-or-

- ▶ Deactivate IceMaker. (see IceMaker / MaxIce )
- ▷ If IceMaker drawer is inserted and IceMaker is activated: IceMaker produces ice cubes.

## 8 Features

### 8.1 Drawers

You can remove the drawers for cleaning.

You can remove the drawers to use VarioSpace.

The way to remove/insert the drawers varies depending on the pull-out system. Your appliance can contain various pull-out systems.

#### Note

The energy consumption increases and the cooling power goes down if ventilation is not sufficient.

- ▶ Leave the bottom drawer in the appliance!
- ▶ Always leave the fan air vents clear on the back wall!

#### 8.1.1 Drawer on telescopic rails

The drawer runs on extendible rails (telescopic rails). There are fully extendible telescopic rails and telescopic rails with partial pull-out. Drawers which are fully extendible can be pulled out fully from the appliance. Drawers with partial pull-out cannot be removed fully from the appliance. The system in your appliance depends on the type of appliance.

#### Drawer on glass shelf

The drawer guided on a glass shelf is a partial pull-out.

#### Removing drawer

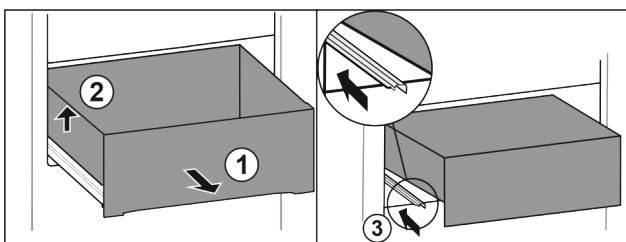

Fig. 92

- ▶ Pull out drawer as far as it will go. Fig. 92 (1)
- ▶ Lift drawer on the left. Fig. 92 (2)

- ▶ Insert left rail. Fig. 92 (3)

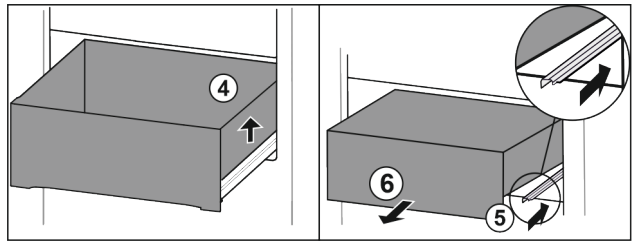

Fig. 93

- ▶ Lift drawer on the right. Fig. 93 (4)
- ▶ Insert right rail. Fig. 93 (5)
- ▶ Remove drawer to the front. Fig. 93 (6)

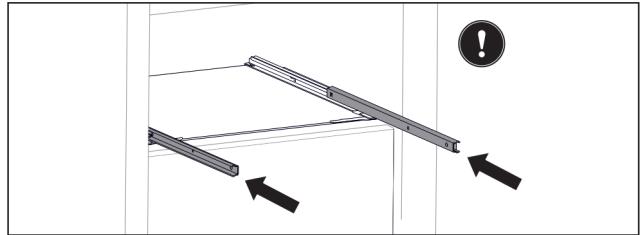

Fig. 94

If the rails are not yet fully inserted after removing the drawer:

- ▶ Push rails in completely.

#### Inserting drawer

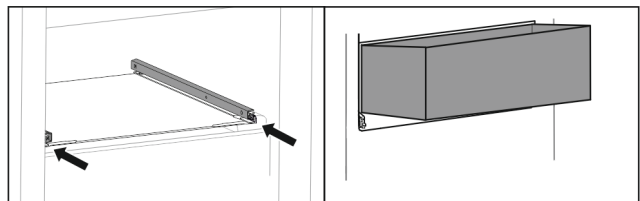

Fig. 95

- ▶ Slide rails in.
- ▶ Place drawer on rails at an angle.

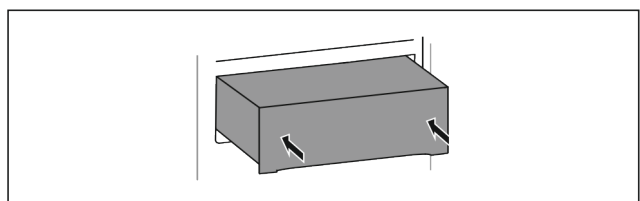

Fig. 96

- ▶ Lower drawer.
- ▶ Slide in drawer to the back.

#### 8.1.2 Top tilting drawer

When you pull out the top drawer, it tilts forward. This gives you a better view into the drawer. The function depends on the height of the appliance.

#### Removing drawer

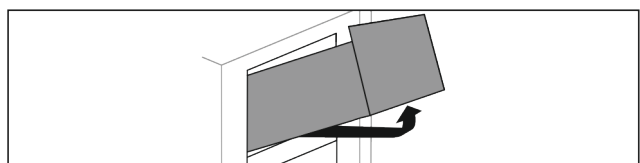

Fig. 97

- ▶ Pull out drawer as far as it will go.
- ▶ Lift drawer at the front.
- ▶ Lift drawer from below.
- ▶ Remove drawer to the front.

# Features

## Inserting drawer

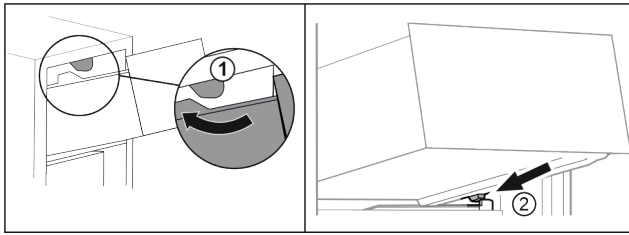

Fig. 98

- ▶ Guide drawer around the upper stoppers. Fig. 98 (1)
- ▶ Place drawer at an angle behind the lower stoppers onto moulded rib. Fig. 98 (2)
- ▶ Lower drawer.
- ▶ Slide to the back.

### 8.1.3 Drawer on moulded rib\*

The drawer runs directly on the moulded rib. There are no rails.

#### Removing drawer

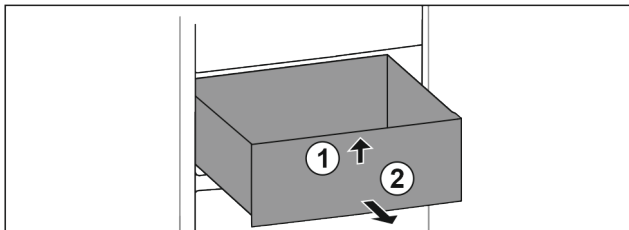

Fig. 99

- ▶ Pull out drawer as far as it will go.
- ▶ Lift up drawer at the front. Fig. 99 (1)
- ▶ Remove drawer to the front. Fig. 99 (2)

#### Inserting drawer

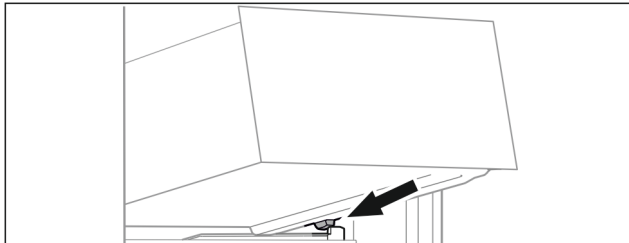

Fig. 100

- ▶ Place drawer at an angle behind the stoppers on the moulded rib. (see Fig. 100)
- ▶ Lower drawer.
- ▶ Slide in drawer to the back.

### 8.1.4 Bottom drawer

The drawer is the lowest drawer in the appliance. It runs directly on the moulded rib. There are no rails.

#### Removing drawer

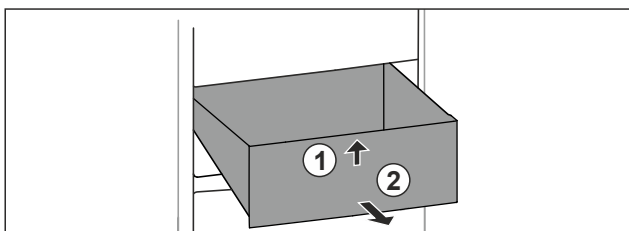

Fig. 101

- ▶ Pull out drawer as far as it will go.
- ▶ Lift up drawer at the front. Fig. 101 (1).
- ▶ Remove drawer to the front. Fig. 101 (2).

## Inserting drawer

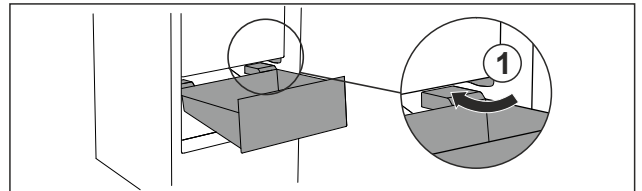

Fig. 102

- ▶ Guide drawer in at an angle around the stoppers Fig. 102 (1).
- ▶ Lower drawer.
- ▶ Slide in drawer to the back.

## 8.2 Pull-out board with IceTower

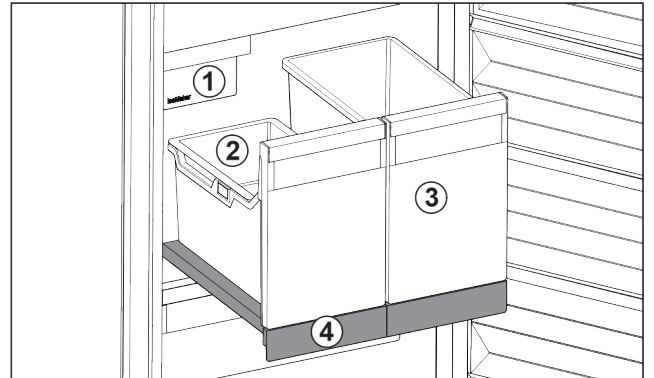

Fig. 103 Pull-out board with IceTower

- (1) IceMaker
- (2) Hang-on tray for ice cubes
- (3) Container for pizza or alcoholic beverages, for example
- (4) Pull-out board

There are two high (IceTower) containers on the pull-out board. Ice cubes from the IceMaker are collected and stored in the Fig. 103 (2) container. The container Fig. 103 (3) is suitable for storing tall foodstuffs or beverages such as pizzas or alcoholic drinks.

The pull-out board with IceTower is mounted on a glass shelf with pull-out rails. You can dismantle the pull-out board for cleaning.

### 8.2.1 Dismantling the pull-out board with IceTower

#### Removing the container

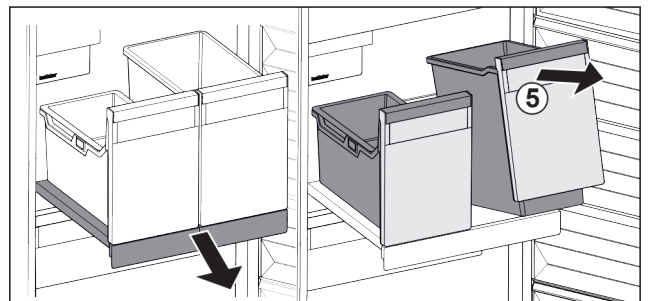

Fig. 104

- ▶ Pull out the pull-out board.
- ▶ Lift the container Fig. 104 (5) at the front.
- ▶ Remove the container.

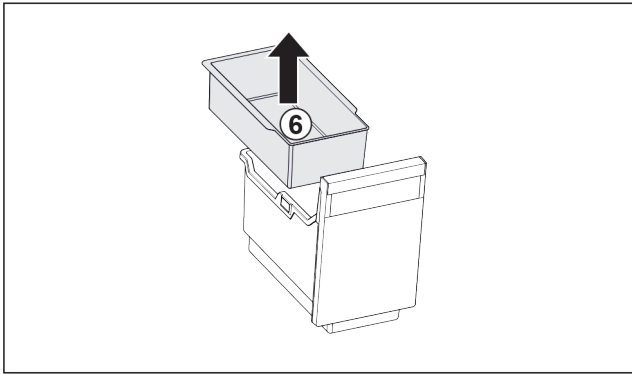

Fig. 105

- ▶ Remove the hang-on tray Fig. 105 (6).
- ▶ If there are ice cubes in the hang-on tray: Empty the hang-on tray.
- ▷ The container and hang-on tray have been removed and you can clean them. (see 9.3.4 Clean the components)

### Removing the pull-out board

Ensure that the following conditions are met:

- Containers have been removed. (see Removing the container)

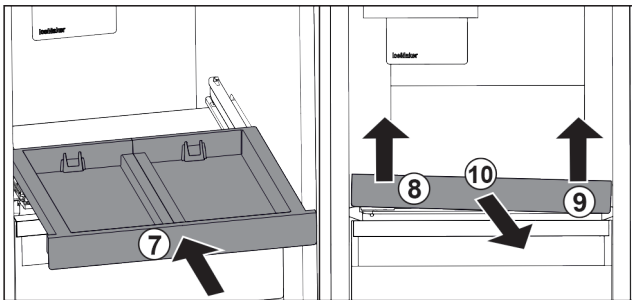

Fig. 106

- ▶ Slide in the pull-out board. Fig. 106 (7)
- ▶ Lift the pull-out board on the front left. Fig. 106 (8)
- ▶ Lift the pull-out board on the front right. Fig. 106 (9)
- ▷ Pull-out board is detached from the attachment at the front.
- ▶ Take out the pull-out board to the front. Fig. 106 (10)
- ▷ The pull-out board has been removed and you can clean it. (see 9.3.4 Clean the components)

### Removing the glass shelf from under the pull-out board

(see 8.3 Glass shelves)

## 8.2.2 Inserting the pull-out board with IceTower

### Inserting the glass shelf from under the pull-out board

(see 8.3 Glass shelves)

### Inserting the pull-out board

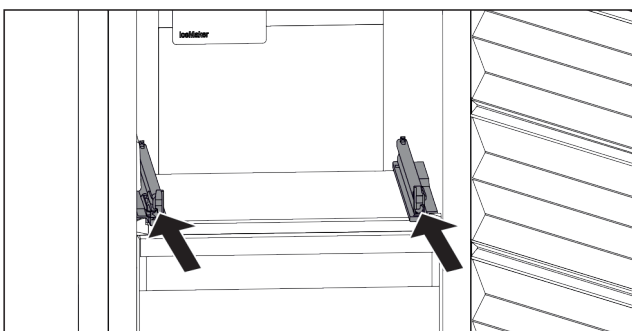

Fig. 107

- ▶ Slide the rails in.

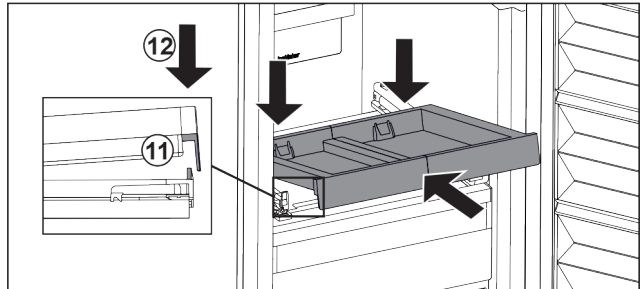

Fig. 108

- ▶ Place the pull-out board in at an angle behind the front lug.
- ▶ Slide in at an angle. Make sure that the stop is behind the lug on both sides. Fig. 108 (11)
- ▶ Lower the pull-out board at the front. Fig. 108 (12)

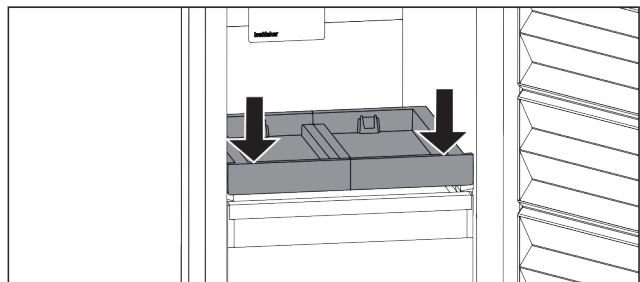

Fig. 109

- ▶ Push the pull-out board down at the front.
- ▷ Pull-out board clicks into place.

### Inserting the container

Ensure that the following conditions are met:

- The pull-out board is inserted. (see Inserting the pull-out board)

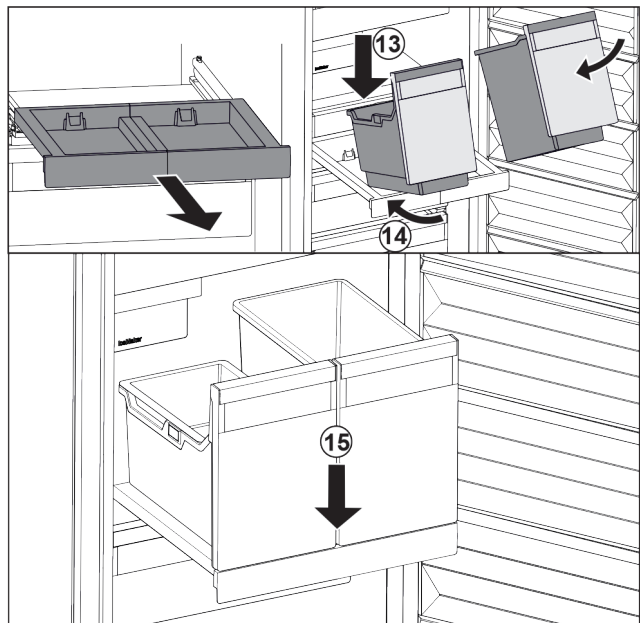

Fig. 110

- ▶ Pull out the pull-out board.
- ▶ Hold the pull-out board with one hand.

### Note

The containers are shaped in a way that they cannot be interchanged.

- ▶ Place the container at an angle on the pull-out board. Fig. 110 (13)
- ▶ Slide the container to the back at an angle. Fig. 110 (14)
- ▶ Place container in the front. Fig. 110 (15)

# Features

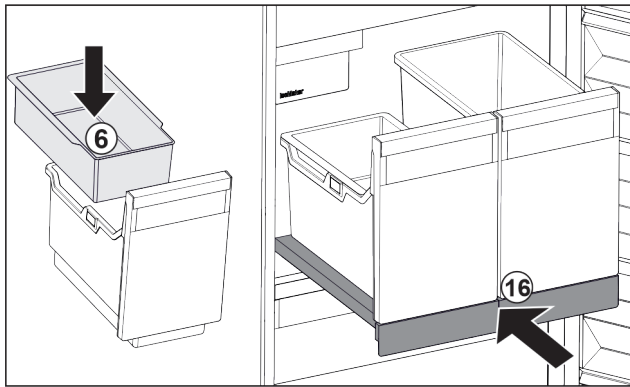

Fig. 111

- ▶ Insert hang-on tray Fig. 111 (6) for ice cubes.
- ▶ Slide in the pull-out board with (IceTower) container. Fig. 111 (16)
- ▷ Pull-out shelf with IceTower is fully inserted.

## 8.3 Glass shelves

### NOTICE

Impermissible removal of the glass panel above the IceTower!  
Damage to the IceMaker. The IceMaker is attached to the glass panel above the IceTower.

- ▶ Do not remove the glass panel above the IceTower.

You can remove the glass shelves under the drawers for cleaning.

You can remove the glass shelves under the drawers to use VarioSpace.

### 8.3.1 Removing / inserting the glass shelf

Make sure that the following requirements are fulfilled:

- Glass shelf under the drawer: The drawer has been removed. (see 8.1 Drawers)
- Pull-out board under IceTower: IceTower has been removed. (see 8.2 Pull-out board with IceTower)

#### Removing glass shelf

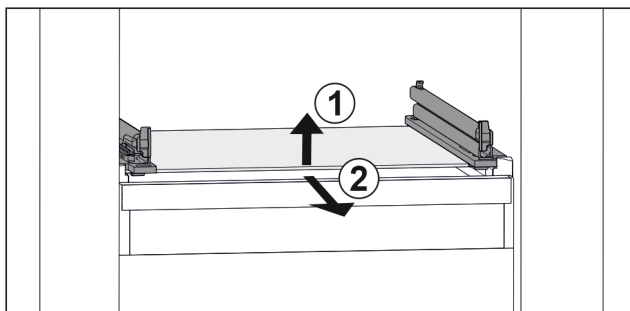

Fig. 112 Example illustration of glass shelf

- ▶ Lift glass shelf at the front. Fig. 112 (1)
- ▶ Take out glass shelf to the front. Fig. 112 (2)

#### Inserting glass shelf

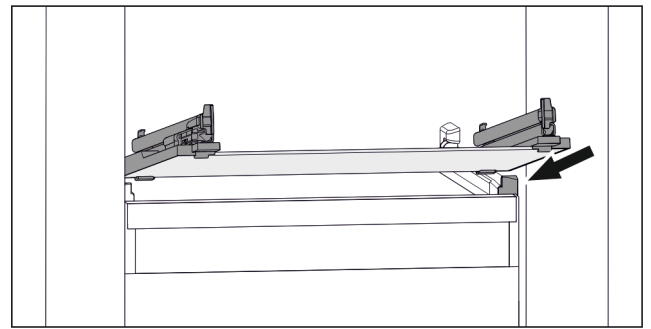

Fig. 113 Example illustration of glass shelf

- ▶ Position glass shelf at an angle behind the stoppers. (see Fig. 113)
- ▶ Lower glass shelf.
- ▶ Slide in glass shelf to the back.

## 8.4 IceMaker

The IceMaker will produce ice cubes for household use only.

Ensure that the following conditions are met:

- IceMaker is cleaned (see 9 Maintenance) .
- IceMaker drawer is cleaned.
- IceMaker drawer is fully inserted.

### 8.4.1 Producing ice cubes

The volume depends on the freezing temperature. The colder the temperature, the more ice cubes the system can produce in a certain time period.

After the IceMaker is turned on for the first time, it can take up to 24 hours for the first ice cubes to be made.

- ▶ Activate the IceMaker function .
- ▶ To make a high number of ice cubes: Activate the MaxIce function .
- ▶ Distribute the ice cubes evenly in the drawer to increase the capacity.
- ▶ Closing the drawer: IceMaker starts making ice cubes again automatically.

#### Note

When a certain level is reached in the IceMaker drawer, it stops producing ice cubes. The IceMaker does not fill the drawer all the way to the top.

## 8.5 VarioSpace

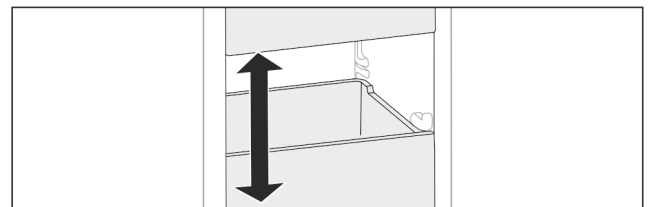

Fig. 114

You can remove drawers and glass panels from your appliance. This provides more room for large food items such as poultry, joints of meat, large game, and tall baked products. You can then freeze these items whole for later preparation.

- ▶ Note the weight limits on the drawers and glass panels (see 10.1 Technical specifications) .

## 8.6 Freezer pack

Freezer packs prevent the temperature rising too quickly should there be a power cut.



The freezer packs are in the drawer.  
You can store the freezer packs in the freezer tray.

## 8.6.1 Using the freezer pack

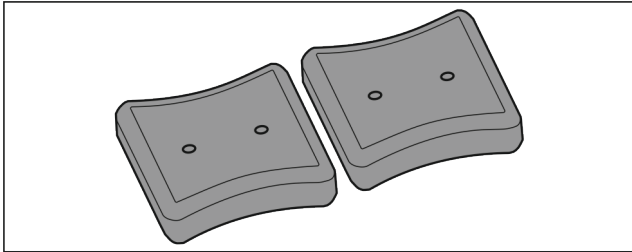

Fig. 115

When the freezer packs are fully frozen:

- ▶ Place on the frozen goods in the top, front part of the freezer.

## 9 Maintenance

### 9.1 Disassembling / assembling pull-out systems

#### 9.1.1 Notes on disassembly

You can disassemble some of the pull-out systems for cleaning. Your appliance can contain a variety of pull-out systems.

The following pull-out systems can be disassembled or cannot be disassembled:

Pull-out system	can be disassembled / cannot be disassembled
Drawer on glass shelf	can be disassembled (see Drawer on glass shelf)
Top tilting drawer	cannot be disassembled
Drawer on moulded rib*	can be disassembled (see 9.1.3 Drawer on moulded rib*) *
Bottom drawer	cannot be disassembled
IceTower	can be disassembled (see 9.1.4 IceTower)

#### 9.1.2 Drawer on telescopic rails

##### Drawer on glass shelf

##### Disassembling pull-out system

Make sure the following prerequisites are met:

- Drawer has been removed.
- Glass shelf has been removed. (see 8.3 Glass shelves)

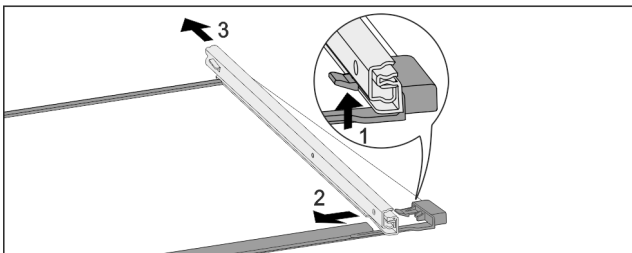

Fig. 116 Glass shelf with rails

- ▶ Push up front click-in hooks. (1)
- ▶ Move pull-out rails to the side (2) and to the rear (3).

#### Installing pull-out system

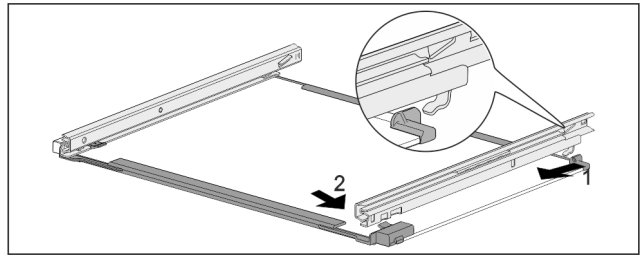

Fig. 117 Glass shelf with rails

- ▶ Hook in rail at the back. (1)
- ▶ Hook in rail at the front. (2)

#### 9.1.3 Drawer on moulded rib\*

##### Disassembling pull-out system

Make sure the following prerequisites are met:

- Drawer has been removed. (see 8.1.3 Drawer on moulded rib\*)

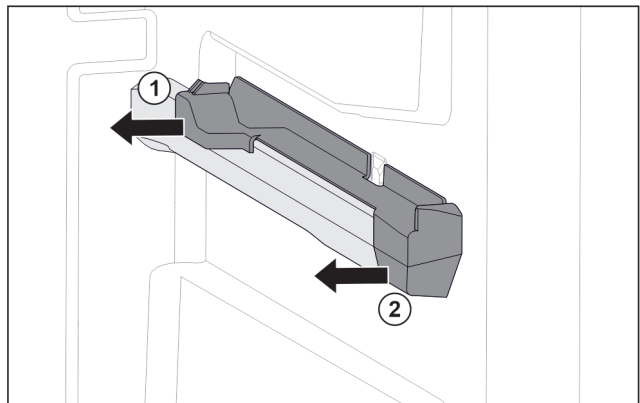

Fig. 118 Attachment on the right moulded rib

- ▶ Grab attachment at the back from below.
- ▶ Pull off attachment at the back sideways. Fig. 118 (1)
- ▶ Pull off attachment at the front sideways. Fig. 118 (2)

##### Installing pull-out system

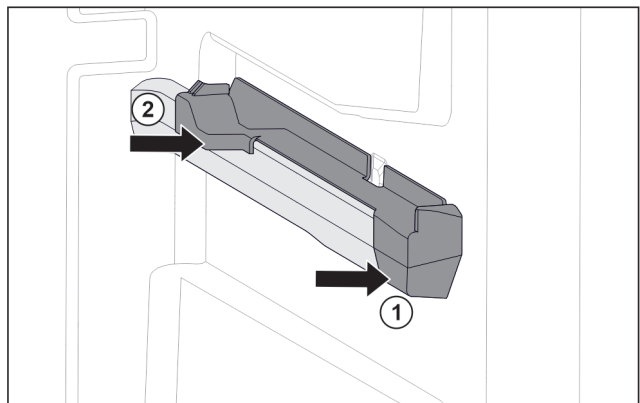

Fig. 119 Attachment on the right moulded rib

- ▶ Position attachment on moulded rib at the front. Fig. 119 (1)
- ▶ Press on attachment at the back. Fig. 119 (2)

#### 9.1.4 IceTower

##### Disassembling pull-out system

Make sure the following prerequisites are met:

- IceTower has been removed. (see 8.2 Pull-out board with IceTower)
- Glass shelf has been removed. (see 8.3 Glass shelves)
- ▶ Place pull-out board on a table.

# Maintenance

- ▷ You are able to remove the rails more easily from the glass shelf.

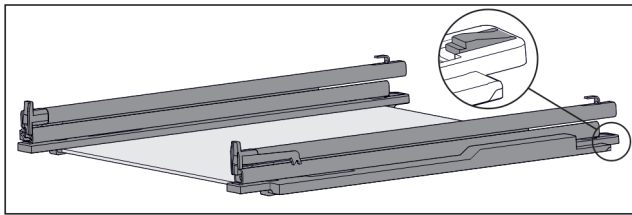

Fig. 120 Glass shelf with rails and retaining parts

- ▶ Press down retaining part at the rear (see Fig. 120) and at the same time push the rail back.

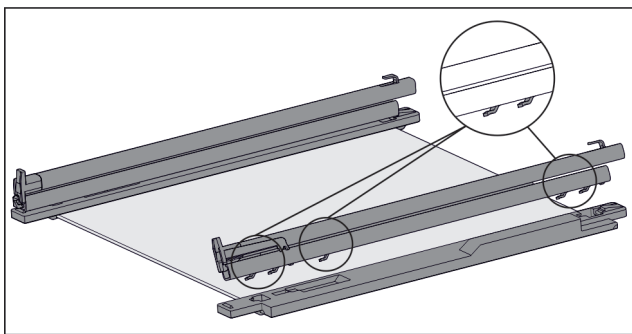

Fig. 121 Glass shelf with rails and retaining parts

- ▷ The rail hooks are released from the retaining part.
- ▶ Remove rail from retaining part.

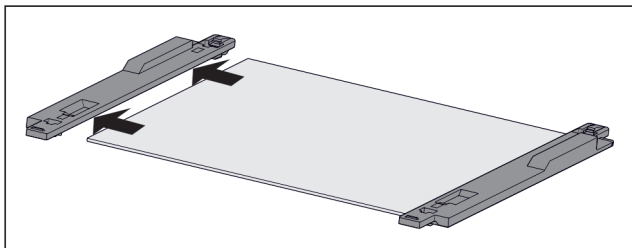

Fig. 122 Glass shelf with retaining part

- ▶ Remove retaining part from glass shelf sideways.

## Installing pull-out system

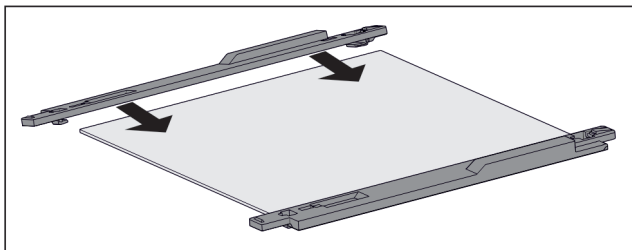

Fig. 123 Glass shelf with retaining part

- ▶ Fit retaining part on glass shelf.
- ▶ Push retaining part onto glass shelf as far as it will go.

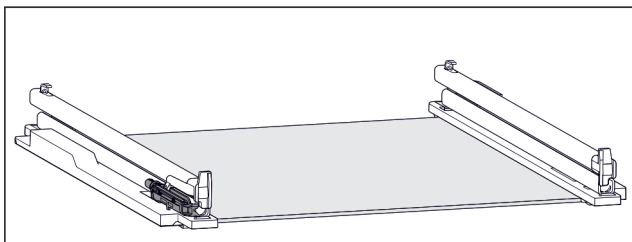

Fig. 124 Damping mechanism

The damping mechanism is attached to the left rail. (see Fig. 124) There is no damping mechanism attached to the right rail.

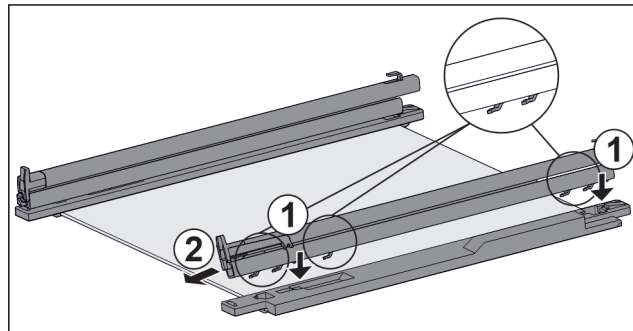

Fig. 125 Glass shelf with rails and retaining parts

Install rail **with** damping mechanism:

- ▶ Place rail hooks onto the openings of the **left** retaining part. Fig. 125 (1)
- ▶ Push rail forwards. Fig. 125 (2)

- ▷ Rail latches in audibly.

Install rail **without** damping mechanism:

- ▶ Place rail hooks onto the openings of the **right** retaining part. Fig. 125 (1)
- ▶ Push rail forwards. Fig. 125 (2)
- ▷ Rail latches in audibly.

## 9.2 Defrosting the appliance

### 9.2.1 Defrosting with NoFrost

Defrosting is performed automatically with the NoFrost system. The moisture is deposited on the evaporator, is periodically defrosted and evaporates.

The appliance does not need to be defrosted.

#### Note

Water droplets may collect on the bottom of the appliance. When you take the appliance out of operation:

- ▶ Place a towel in front of the appliance to catch any drops of water that may run out. (see 11 Shutting down)

## 9.3 Cleaning the appliance

### 9.3.1 Ready



#### WARNING

Danger of electric shock!

- ▶ Remove the refrigerator connector or interrupt the power supply.



#### WARNING

Risk of fire

- ▶ Do not damage the refrigeration circuit.

- ▶ Empty the appliance.
- ▶ Remove mains connector.

### 9.3.2 Clean the housing

#### NOTICE

Improper cleaning!

Damage to the appliance.

- ▶ Only use soft cleaning cloths and ph-neutral all-purpose cleaners.
- ▶ Do not use abrasive sponges or steel wool which may cause scratches.
- ▶ Do not use any sharp or abrasive cleaning agents, nor any that contain sand, chloride or acid.



## WARNING

Risk of injury and damage as a result of hot steam!  
Hot steam can lead to burns and can damage the surfaces.

▶ Do not use any steam cleaners!

▶ Wipe the housing down with soft, clean cloth. If very dirty, use lukewarm water with a neutral cleaner. Glass surfaces can also be cleaned with glass cleaner.

### 9.3.3 Cleaning the interior

#### NOTICE

Improper cleaning!  
Damage to the appliance.

- ▶ Only use soft cleaning cloths and ph-neutral all-purpose cleaners.
- ▶ Do not use abrasive sponges or steel wool which may cause scratches.
- ▶ Do not use any sharp or abrasive cleaning agents, nor any that contain sand, chloride or acid.

- ▶ Plastic surfaces: clean by hand with a soft clean cloth, lukewarm water and a little detergent.
- ▶ Metal surfaces: clean by hand with a soft clean cloth, lukewarm water and a little detergent.

### 9.3.4 Clean the components

#### NOTICE

Improper cleaning!  
Damage to the appliance.

- ▶ Only use soft cleaning cloths and ph-neutral all-purpose cleaners.
- ▶ Do not use abrasive sponges or steel wool which may cause scratches.
- ▶ Do not use any sharp or abrasive cleaning agents, nor any that contain sand, chloride or acid.

**Clean with a soft, clean cloth, lukewarm water and some detergent:**

- IceTower pull-out board
- Drawer  
Please note: Do not remove the magnet on the drawer. The magnet ensures the functionality of the IceMaker.
- Freezer tray

**Clean with a damp cloth:**

- Retractable rails  
Please note: The grease in the tracks is used for lubrication and must not be removed!

**Wash in the dishwasher up to 60 °C:**

- Ice cube scoop
- ▶ To disassemble components: see the relevant section.
- ▶ Clean the components.

### 9.3.5 Cleaning the IceMaker

There are various options for cleaning the IceMaker.

Cleaning is required in the following cases:

- Initial operation
- With mains connection:  
If out of use for more than 5 days.

Ensure that the following conditions are met:

- IceMaker drawer is emptied.
- IceMaker drawer is in place.
- The IceMaker is activated.

**First use or after a long period of non-use**

Clean the IceMaker with the TubeClean function.

- ▶ Put an empty 1.5 l vessel (max. height 10 cm) in the drawer under the IceMaker.
- ▶ Activate the TubeClean function.
  - ▷ The rinse process is prepared (max. 60 min.): Symbol flashes.
  - ▷ Water pipes are rinsed: Symbol flashes.
  - ▷ Rinsing process is complete: Function turns off automatically.
- ▶ Remove the IceMaker drawer and remove the container.
- ▶ Clean the IceMaker drawer with warm water and a little detergent.
- ▶ Push the IceMaker drawer in.
  - ▷ The system starts making ice cubes automatically.
- ▶ Dispose of any ice cubes that were made 24 hours after the first ice cubes.

#### If cleaning is required

Clean the IceMaker by hand.

- ▶ Remove the IceMaker drawer and clean with warm water and a little detergent.
- ▶ Push the IceMaker drawer in.
  - ▷ The system starts making ice cubes automatically.

### 9.3.6 After cleaning

- ▶ Wipe the appliance and the components dry.
- ▶ Connect and switch on the appliance.
- ▶ Activate SuperFrost (see 7.2 Appliance functions) .  
The temperature is cold enough:
- ▶ Place the food inside.
- ▶ Repeat cleaning regularly.

## 10 Customer help

### 10.1 Technical specifications

Temperature range	
Freeze	-28 °C to -15 °C

Maximum freezing quantity/24 h	
Freezer compartment	See "Freezing capacity .../24 h" on the type plate

Maximum component capacity			
Features	Appliance width 550 mm (see installation instructions, appliance dimensions)	Appliance width 600 mm (see installation instructions, appliance dimensions)	Appliance width 700 mm (see installation instructions, appliance dimensions)
Drawer on moulded rib* (see 8.1.3 Drawer on moulded rib*) *	14 kg*	19 kg*	19 kg*
Drawer on glass shelf (see 8.1.1 Drawer on telescopic rails)	12 kg	15 kg	22 kg
Bottom drawer (see 8.1.4 Bottom drawer)	--	11 kg	19 kg

Maximum component capacity			
Features	Appliance width 550 mm (see installation instructions, appliance dimensions)	Appliance width 600 mm (see installation instructions, appliance dimensions)	Appliance width 700 mm (see installation instructions, appliance dimensions)
Top tilting drawer (see 8.1.2 Top tilting drawer)	--	19 kg	19 kg

Ice cube production with IceMaker	
Ice cube production/24 h	At a temperature of -18 °C: 0.8 kg of ice cubes
Maximum ice cube production/24 h	With the MaxIce function on: 1.2 kg of ice cubes

Lighting	
Class <sup>1</sup>	Light source
This product contains one or more energy efficiency class G light sources.	LED

<sup>1</sup> The appliance may contain light sources with different energy efficiency classes. The lowest energy efficiency class is indicated.

For appliances with a WiFi connection:

Frequency specification	
Frequency band	2.4 GHz
Maximum radiated power	< 100 mW
Purpose of the wireless equipment	Integration in the local WiFi network for data communication

## 10.2 Operating noises

The appliance makes different noises when it is on.

- At **higher temperatures** the appliance uses less energy but works for longer. It is **quieter**.
- At **lower temperatures** the food is cooled faster. It is **louder**.

Examples:

- Functions on (see 7.2 Appliance functions)
- Fan running
- Food recently added
- High ambient temperature
- Door open for a while

Defect	Cause	Remedy
<b>The appliance is not working.</b>	→ The appliance is not switched on.	▶ Switch the appliance on.
	→ The power plug is not properly plugged into the socket.	▶ Check the power plug.

Noise	Possible cause	Type of noise
Bubbling and splashing	Coolant flowing into the cooling circuit.	Normal operating noise
Hissing	Coolant sprays into the cooling circuit.	Normal operating noise
Humming	The appliance is cooling. The volume depends on the cooling output.	Normal operating noise
Suction noises*	Soft-closing door is being opened and closed.*	Normal operating noise*
Humming and rustling	The fan is running.	Normal operating noise
Clicking	Components are switched on and off.	Normal switching noise
Rattling or humming	Valves or flaps are working.	Normal switching noise
Faint knocking, humming or buzzing*	The valve is active.	Normal operating noise

Noise	Possible cause	Type of noise	Lifting
Vibration	Improper setup	Defective noise	Level the appliance using the adjustable feet.
Rattling	Components, items inside the appliance	Defective noise	Secure components. Leave enough space between the items.

## 10.3 Technical fault

Your appliance is designed and built to ensure it works reliably and has a long service life. In the unlikely event that a fault occurs during operation, please check whether it is due to an operating error. If so, you will be charged for the callout and repair costs even if it falls within the warranty period.

You can fix the following faults yourself.

### 10.3.1 Appliance function

Defect	Cause	Remedy
	→ There is something wrong with the power outlet fuse.	▶ Check the fuse.
	→ Power cut	▶ Keep the appliance closed. ▶ Protecting food: Lay freezer packs on top of the food or use another freezer if the power is off for a prolonged period. ▶ Do not re-freeze defrosted food,
	→ The appliance plug does not fit the appliance properly.	▶ Check the appliance plug.
<b>Temperature is not cold enough.</b>	→ The appliance door is not closed properly.	▶ Close the appliance door.
	→ Not enough ventilation.	▶ Keep ventilation grille clear, and clean it.
	→ The ambient temperature is too high.	▶ Problem solution: (see 1.4 Appliance range of use)
	→ The appliance was opened too many times or for too long.	▶ Wait to see if the required temperature corrects itself. If not, contact Customer Service. (see 10.4 Customer Service)
	→ Too much fresh food was placed inside without SuperFrost.	▶ Solution: (see SuperFrost)
	→ The temperature is set incorrectly.	▶ Turn down the temperature and check after 24 hours.
	→ The appliance is too close to a heat source (oven, radiator, etc).	▶ Move the appliance or the heat source.
<b>The status display does not light up.*</b>	→ The status display is switched off.	▶ Switch on the status display. (see Status light (status display)*)
	→ The door is open.	▶ Close the door.
	→ The appliance is switched off.	▶ Switch the appliance on.
	→ LED is faulty.	▶ Contact Customer Service. (see 9 Maintenance)
<b>The door seal is defective or needs to be replaced for another reason.</b>	→ The door seal can be replaced. It can be replaced without the need for special tools.	▶ Contact Customer Service. (see 10.4 Customer Service)
<b>The appliance builds up too much ice or condensation.</b>	→ The door seal may have slipped out of its groove.	▶ Check that the door seal is well fitted in the groove.
<b>The appliance is hot to touch on the outside*.</b>	→ The heat of the refrigeration circuit is used to avoid condensation.	▶ This is normal.

## 10.3.2 Features

Defect	Cause	Remedy
<b>You cannot activate the IceMaker.</b>	→ The appliance and therefore the IceMaker are not connected.	▶ Connect the appliance (see the Installation Guide).
<b>The IceMaker is not producing ice cubes.</b>	→ The IceMaker is not on.	▶ Activate the IceMaker.
	→ The drawer of the IceMakers is not connected properly.	▶ Push the drawer in correctly.
	→ The water connection is not open.	▶ Open the water connection.
<b>The internal light does not come on.</b>	→ The appliance is not switched on.	▶ Switch the appliance on.

# Shutting down

Defect	Cause	Remedy
	→ The door was open for longer than 15 minutes.	▶ Interior lighting turns off automatically after approx. 15 min. with the door open.
	→ The LED interior light is faulty or the lid is damaged.	▶ Contact Customer Service. (see 10.4 Customer Service)

## 10.4 Customer Service

First check whether you can rectify the fault yourself (see 10 Customer help) . If you cannot rectify the problem, contact Customer Service.

You can find the address in the enclosed brochure “Liebherr-Service” or at [home.liebherr.com/service](http://home.liebherr.com/service).



### WARNING

Unprofessional repair!  
Injuries.

- ▶ Have any repairs and action - not expressly specified - on the appliance and mains cable carried out by service personnel only. (see 9 Maintenance)
- ▶ A damaged mains cable may only be replaced by the manufacturer, the manufacturer’s Customer Service or a similarly qualified person.
- ▶ In the case of appliances with an IEC connector, the change may be made by the customer.

### 10.4.1 Contacting Customer Service

Make sure that the following appliance information is available:

- Appliance name (model and index)
  - Service no. (Service)
  - Serial no. (S no.)
  - ▶ Call up the appliance information via the display. (see Device information)
- or-**
- ▶ Refer to the type plate for appliance information. (see 10.5 Model plate)
  - ▶ Note down the appliance information.
  - ▶ Notify customer service: Report errors and the appliance information.
  - ▷ This will help us to provide you with a faster, more accurate service.
  - ▶ Follow further instructions from Customer Service.

## 10.5 Model plate

The model plate is behind the drawers on the inside of the appliance.

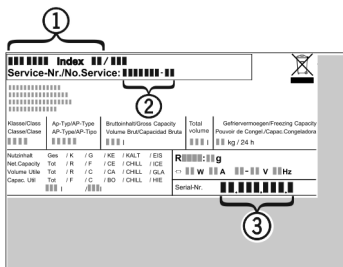

Fig. 126

- (1)** Appliance description      **(3)** Serial no.
- (2)** Service no.
- ▶ Note the data on the model plate.

## 11 Shutting down

- ▶ Empty the appliance.
- ▶ Deactivate IceMaker. (see Deactivating the IceMaker / MaxIce )
- ▶ Switch off appliance. (see Switching the appliance off and on)
- ▶ Remove mains connector.
- ▶ Remove appliance connector if required: Remove and move from left to right at the same time.
- ▶ Place a towel in front of the appliance to catch any drops of water that may run out.
- ▶ Clean appliance. (see 9.3 Cleaning the appliance)
- ▶ Leave the door open, so that no unpleasant odours arise.

## 12 Disposal

### 12.1 Preparing appliance for disposal



Liebherr uses batteries in some of its appliances. In the EU, for environmental reasons, legislation obliges the end user to remove these batteries before disposing of old appliances. If your appliance contains batteries, a corresponding notice is attached.

**Lamps** If you can remove the lamps yourself without destroying them, also remove these before disposal.

- ▶ Take the appliance out of operation.
- ▶ Appliances with batteries: remove the batteries. For description, see **Maintenance** chapter.
- ▶ If possible: remove lamps without destroying them.

### 12.2 Disposing of the appliance in an environmentally friendly manner



The appliance still contains valuable materials and must be disposed of separately from unsorted municipal waste.



Dispose of batteries separately from the old appliance. To do this, you can return the batteries free of charge to retailers as well as recycling centres and collection centres for recyclable materials.

**Lamps**

Dispose of removed lamps via the respective collection systems.

For Germany:

You can dispose of the appliance free of charge via the class 1 collection containers at the local recycling and recyclable material collection centres. When purchasing a new fridge/freezer, if the sales area > 400 m<sup>2</sup>, retailers will also take back the old appliance free of charge.



## **WARNING**

Leaking coolant and oil!

Fire. The coolant contained in the appliance is eco-friendly, but also flammable. The oil contained in the appliance is flammable. Escaping coolant and oil can ignite if the concentration is high enough and in contact with an external heat source.

- ▶ Do not damage the pipelines of the coolant circuit and the compressor.
- 
- ▶ Observe the notes on transporting the appliance.
  - ▶ Transport the appliance without damaging it.
  - ▶ Dispose of batteries, lamps and the appliance according to the above specifications.



[home.liebherr.com/fridge-manuals](https://home.liebherr.com/fridge-manuals)

**EN** freezer

Issue date: 20240526

**Part number index: 7088534-00**

Liebherr-Hausgeräte GmbH  
Memminger Straße 77-79  
88416 Ochsenhausen  
Deutschland





User Guide

Quality, Design and Innovation



[home.liebherr.com/fridge-manuals](http://home.liebherr.com/fridge-manuals)



# LIEBHERR

# Contents

<b>1</b>	<b>Appliance at a glance.....</b>	<b>3</b>
1.1	Scope of delivery.....	3
1.2	Overview of the appliance and equipment.....	3
1.3	SmartDevice.....	3
1.4	Appliance range of use.....	4
1.5	Conformity.....	4
1.6	SVHC substances according to REACH regulation.....	4
1.7	EPREL database.....	4
<b>2</b>	<b>General safety instructions.....</b>	<b>4</b>
<b>3</b>	<b>Functionality of the Touch &amp; Swipe display.....</b>	<b>6</b>
3.1	Navigation and symbol explanation.....	6
3.2	Menus.....	6
3.3	Sleep mode.....	7
<b>4</b>	<b>Putting into operation.....</b>	<b>7</b>
4.1	Switching on appliance (first use).....	7
<b>5</b>	<b>Storage.....</b>	<b>7</b>
5.1	Information regarding storage.....	7
5.2	Fridge compartment.....	8
5.3	EasyFresh .....	8
5.4	Storage times.....	8
<b>6</b>	<b>Saving energy.....</b>	<b>8</b>
<b>7</b>	<b>Controls.....</b>	<b>8</b>
7.1	Controls and displays.....	8
7.1.1	Status display.....	8
7.1.2	Display symbols.....	8
7.2	Appliance functions.....	8
7.2.1	Notes on the appliance functions.....	8
	Turn off appliance.....	8
	WiFi.....	9
	Temperature.....	10
	Temperature unit.....	10
	D-Value.....	10
	SuperCool.....	10
	PowerCool .....	10
	HolidayMode.....	11
	SabbathMode.....	11
	EnergySaver .....	12
	CleaningMode.....	12
	Display brightness.....	12
	Door alarm.....	13
	Input lock.....	13
	Language.....	13
	Info.....	13



	Reminder.....	14
	Demo mode.....	14
	Resetting to factory settings.....	14
7.3	Fault messages.....	15
7.3.1	Warnings.....	15
<b>8</b>	<b>Features.....</b>	<b>15</b>
8.1	Shelves.....	15
8.2	Dividing shelf.....	15
8.3	VarioSafe .....	16
8.4	Drawers.....	18
8.5	EasyFresh-Safe cover.....	19
8.6	Adjusting the moisture levels.....	19
8.7	Glass shelves.....	19
8.8	Butter dish.....	20
8.9	Egg rack.....	20
8.10	Bottle holder.....	20
<b>9</b>	<b>Maintenance.....</b>	<b>20</b>
9.1	FreshAir carbon filter.....	20
9.2	Disassembling / assembling pull-out systems.....	21
9.3	Defrosting the appliance.....	21
9.4	Cleaning the appliance.....	21
<b>10</b>	<b>Customer help.....</b>	<b>22</b>
10.1	Technical specifications.....	22
10.2	Operating noises.....	22
10.3	Technical fault.....	23
10.4	Customer Service.....	24
10.5	Model plate.....	24
<b>11</b>	<b>Shutting down.....</b>	<b>24</b>
<b>12</b>	<b>Disposal.....</b>	<b>24</b>
12.1	Preparing appliance for disposal.....	24
12.2	Disposing of the appliance in an environmentally friendly manner.....	24

The manufacturer is continually working on the further development of all types and models. Please be aware that we reserve the right to make changes to the shape, equipment and technology.

Symbol	Explanation
	<p><b>Read instructions</b></p> <p>Please read the information in these instructions carefully to understand all of the benefits of your new appliance.</p>
	<p><b>Full instructions on the internet</b></p> <p>You can find detailed instructions on the internet using the QR code on the front of these instruction or by entering the service number at <a href="http://home.liebherr.com/fridge-manuals">home.liebherr.com/fridge-manuals</a>.</p> <p>The service number can be found on the serial tag:</p> <div style="text-align: center;"> </div> <p style="text-align: right;"><i>Fig. Example illustration</i></p>

Symbol	Explanation
	<b>Check appliance</b> Check all parts for transport damage. If you have any complaints, please contact your agent or customer service.
	<b>Differences</b> These instructions apply to a range of models, so differences are possible. Sections that apply to certain models only are marked with an asterisk (*).
	<b>Instructions and results</b> Instructions are marked with a ▶. Results are marked with a ▷.
	<b>Videos</b> Videos about the appliances are available on the YouTube channels of Liebherr-Hausgeräte.

These operating instructions apply to:

SR ... 52..i

## 1 Appliance at a glance

### 1.1 Scope of delivery

Check all parts for transport damage. Contact your dealer or customer service in the event of complaints. (see 10.4 Customer Service)

Your new appliance comes with the following parts:

- Standalone appliance
- Features (depending on the model)
- Installation materials (depending on the model)
- "Quick Start Guide"
- "Installation Guide"
- Service Brochure

### 1.2 Overview of the appliance and equipment

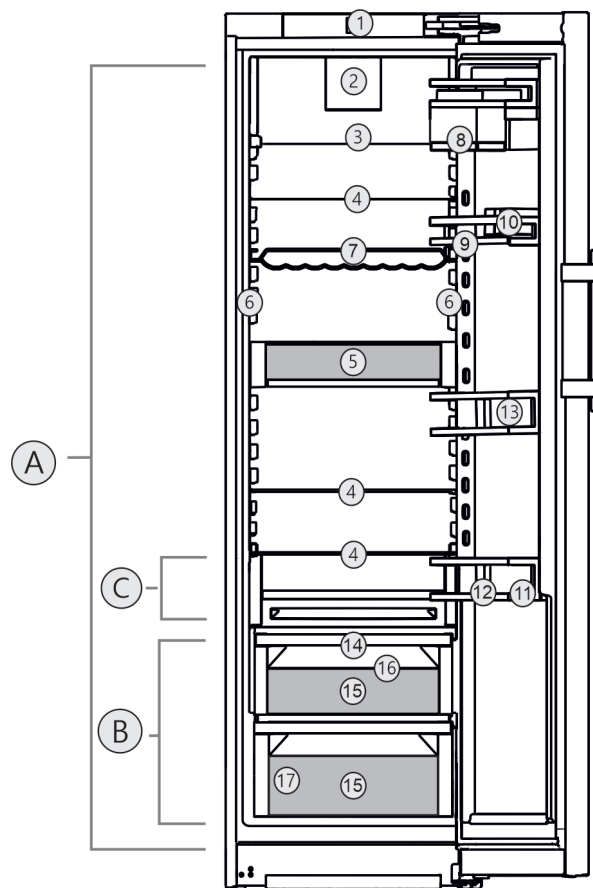

Fig. 1 Example illustration

#### Temperature range

- (A) Fridge compartment      (C) Coldest zone  
(B) EasyFresh

#### Equipment

- |   |                             |
|---|-----------------------------|
| (1) Control and display elements                | (10) Butter dish            |
| (2) Fan with FreshAir activated charcoal filter | (11) Bottle rack            |
| (3) Separable storage shelf                     | (12) Bottle holder          |
| (4) Storage shelf                               | (13) Door shelf             |
| (5) VarioSafe                                   | (14) Lid for EasyFresh-Safe |
| (6) LED Light column, both sides                | (15) EasyFresh-Safe         |
| (7) Bottle shelf                                | (16) Outlet                 |
| (8) VarioBox                                    | (17) Serial tag             |
| (9) Can rack                                    |                             |

#### Note

▶ Shelves, drawers and baskets are arranged for optimum energy efficiency when the appliance is delivered. Changing how the shelves, for example, are inserted in the fridge compartment does not have any impact on energy consumption.

### 1.3 SmartDevice

SmartDevice is the networking solution for your refrigerator. If your appliance SmartDevice-enabled or compatible, you can quickly and easily connect your appliance to your WiFi. With the SmartDevice app, you can operate your appliance from a mobile device. Additional functions and setting options are available in the SmartDevice SmartDevice app.

# General safety instructions

SmartDevice-enabled appliance: Your appliance is capable of being a SmartDevice. To be able to connect your device to WiFi, you need to download the SmartDevice app.



More information about SmartDevice: [smartdevice.liebherr.com](http://smartdevice.liebherr.com)

Downloading the SmartDevice app:



After installing and configuring the SmartDevice, you can connect your appliance to the WiFi using the SmartDevice app and the WiFi appliance function (see WiFi).

## Note

The SmartDevice function is not available in the following countries: Russia, Belarus, Kazakhstan.

## 1.4 Appliance range of use

### Intended use

The appliance is only suitable for cooling food products in a domestic or household-like environment. This includes, for example, use:

- in staff kitchens, bed and breakfast establishments,
- by guests in country houses, hotels, motels and other accommodation,
- for catering and similar services in the wholesale trade.

The appliance is not suitable for freezing food;

The appliance is not suitable as a built-in unit.

All other types of use are not permitted.

### Foreseeable misuse

The following applications are expressly forbidden:

- Storing and refrigerating medicines, blood plasma, laboratory preparations or similar substances and products based on the Medical Device Directive 2007/47/EC
- Use in areas at risk of explosions

Misusing the appliance may lead to damage to the goods stored or they may spoil.

### Climate classifications

Depending on the climate classification the appliance is designed to operate in restricted

ambient temperatures. The climate classification applying to your appliance is printed on the rating plate.

## Note

► Keep to the specified ambient temperatures in order to guarantee that the appliance works properly.

Climate classification	for ambient temperatures of
SN	10 °C to 32 °C
N	16 °C to 32 °C
ST	16 °C to 38 °C
T	16 °C to 43 °C
SN-ST	10 °C to 38 °C
SN-T	10 °C to 43 °C

## 1.5 Conformity

The refrigerant circuit has been tested for leaks. The appliance complies with the applicable safety regulations and with the corresponding directives.

For the EU market: The appliance complies with directive 2014/53/EU.

For the GB market: The appliance complies with Radio Equipment Regulations 2017 SI 2017 No. 1206.

The full text of the EU Declaration of Conformity is available on the following website: [www.Liebherr.com](http://www.Liebherr.com)

## 1.6 SVHC substances according to REACH regulation

You can check whether your appliance contains SVHC substances according to REACH regulation at the following link: [home.liebherr.com/de/deu/de/liebherr-erleben/nachhaltigkeit/umwelt/scip/scip.html](http://home.liebherr.com/de/deu/de/liebherr-erleben/nachhaltigkeit/umwelt/scip/scip.html)

## 1.7 EPREL database

Details about energy labelling and ecodesign requirements will be available on the European product database (EPREL) from 1st March 2021. You can access the product database at the following link: <https://eprel.ec.europa.eu/> You will be asked to enter the model ID. You can find the model ID on the nameplate.

# 2 General safety instructions

Please keep these operating instructions in a safe place so you can refer back to them at any time.

If you pass the appliance on, please hand these operating instructions to the next user.

Read these operating instructions carefully before use to ensure safe and correct use of the appliance. Follow the instructions, safety instructions and warning messages included

at all times. They are important for ensuring you can operate and install the appliance safely and without any problems.

### **Danger for the user:**

- This device can be used by children and people with impaired physical, sensory or mental abilities or with a lack of experience and knowledge provided that they are supervised or have received instruction in the safe use of this device, and about the resulting hazards. Children must not play with this appliance. Cleaning and user maintenance work must not be carried out by children without adult supervision. Children aged between 3 and 8 are allowed to load and unload the appliance. Children below the age of 3 must be kept away from the appliance unless they are under continuous adult supervision.
- The socket must be easily accessible so that the appliance can be disconnected quickly from the electricity in an emergency. It must not be located in the area behind the appliance.
- When disconnecting the appliance from the supply, always take hold of the plug. Do not pull the cable.
- In the event of a fault pull out the mains plug or deactivate the fuse.
- Do not damage the mains power cable. Do not operate the appliance with a defective mains power cable.
- Only customer service or other specially trained staff may repair or perform other operations on the appliance.
- Only assemble, connect and dispose of the appliance according to the instructions.

### **Fire hazard:**

- The coolant used (information on the model plate) is ecofriendly but also flammable. Any leaking coolant may ignite.
  - Do not damage the refrigerant circuit pipes.
  - Do not handle ignition sources inside the appliance.
  - Do not use electrical appliances inside the appliance (e.g. steam cleaners, heaters, ice cream makers, etc.).
  - If the refrigerant leaks: remove any naked flames or ignition sources from the vicinity of the leakage point. Properly air the room. Inform customer services.
- Do not store explosives or sprays using combustible propellants such as butane, propane, pentane, etc. in the appliance. To

identify these spray cans, look for the list of contents printed on the can, or a flame symbol. Gases possibly escaping may ignite due to electrical components.

- Keep burning candles, lamps and other items with naked flames away from the appliance so that they do not set the appliance on fire.
- Please be sure to store alcoholic drinks or other packaging containing alcohol in tightly closed containers. Any alcohol that leaks out may be ignited by electrical components.

### **Danger of tipping and falling:**

- Do not misuse the plinth, drawers, doors etc. as a step or for support. This applies particularly to children.

### **Danger of food poisoning:**

- Do not consume food which has been stored too long.

### **Danger of frostbite, numbness and pain:**

- Avoid prolonged skin contact with cold surfaces or refrigerated/frozen goods or take protective measures, e.g wear gloves.

### **Danger of injury and damage:**

- Hot steam can lead to injury. Do not use electrical heating or steam cleaning equipment, open flames or defrosting sprays to defrost.
- Do not use sharp implements to remove the ice.

### **Risk of crushing:**

- Do not hold the hinge when opening and closing the door. Fingers may get caught.

### **Symbols on the appliance:**



This symbol may be located on the compressor. It relates to the oil in the compressor and makes reference to the risk that: Swallowing or inhaling can be fatal. This advice is only relevant to recycling. There is no danger in normal operation.



This symbol is located on the compressor and indicates the danger of flammable materials. Do not remove the sticker.



This or a similar sticker may be located on the rear of the appliance. This sticker indicates that there are vacuum insulation panels (VIP) or perlite panels in the door and/or housing. This advice is only relevant to recycling. Do not remove the sticker.

### **Please note the warning messages and other specific advice in the other chapters:**

# Functionality of the Touch & Swipe display

	DANGER	indicates an immediately hazardous situation which will lead to death or serious injuries if it is not avoided.
	WARNING	indicates a hazardous situation which may lead to death or serious injuries if it is not avoided.
	CAUTION	indicates a hazardous situation which may lead to minor or moderate injuries if it is not avoided.
	NOTICE	indicates a hazardous situation which may lead to damage to property if it is not avoided.
	Note	indicates useful instructions and tips.

## 3 Functionality of the Touch & Swipe display

You operate your appliance using the Touch & Swipe display. You select appliance functions in the Touch & Swipe display (hereafter referred to as display) by tapping them. If you do not perform any action on the display for 10 seconds, the display either jumps back to the higher-level menu or directly to the status display.

### 3.1 Navigation and symbol explanation

In the illustrations, different symbols are used to navigate the display. The following table describes these symbols.

Symbol	Description
	<b>Briefly touch the display:</b> Activates/deactivates function. Confirms selection. Opens submenu.
	<b>Touch the display for a specified time (e.g. 3 seconds):</b> Activates/deactivates function or value.
	<b>Swipe left or right:</b> Navigate in the menu.
	<b>Briefly touch the Back symbol:</b> Jumps back one menu level.
	<b>Press and hold the Back symbol for 3 seconds:</b> Jumps back to the status display.
	<b>Arrow with clock:</b> It takes more than 10 seconds for the following message to appear in the display.

Symbol	Description
	<b>Arrow with a time indication:</b> It takes the specified amount of time until the following message appears in the display.
	<b>“Open Settings menu” symbol:</b> Navigates to the Settings menu and opens the settings menu. If necessary: Navigate to the desired function in the Settings menu. (see 3.2.1 Opening the Settings menu)
	<b>“Open Advanced menu” symbol:</b> Navigates to the Advanced menu and opens the advanced menu. If necessary: Navigate to the desired function in the Advanced menu. (see 3.2.2 Opening the expanded menu)
No action for 10 seconds	If you do not perform any action on the display for 10 seconds, the display either jumps back to the higher-level menu or directly to the status display.
Open door and close it again.	If you open the door and immediately close it again, the display jumps directly back to the status display.

Note: Illustrations of the display are shown in the English version.

### 3.2 Menus

The appliance functions are distributed over various menus:

Menu	Description
Main menu	When you switch the appliance on, you are automatically in the main menu. From here you can navigate to the most important appliance functions, to the Settings menu and to the Advanced menu.
Settings menu	The Settings menu contains additional appliance functions for setting up your appliance.
Advanced menu	The advanced menu contains special appliance functions for setting up your appliance. Access to the Advanced menu is protected by the numerical code <b>1 5 1</b> .

#### 3.2.1 Opening the Settings menu

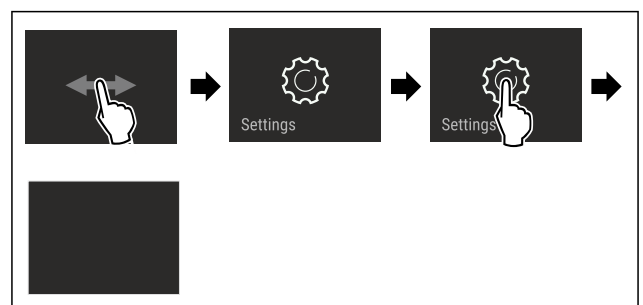

Fig. 2 Example illustration

- ▶ Carry out action steps according to the illustration.
- ▷ Settings menu is open.
- ▶ If necessary: Navigate to the desired function.

## 3.2.2 Opening the expanded menu



Fig. 3

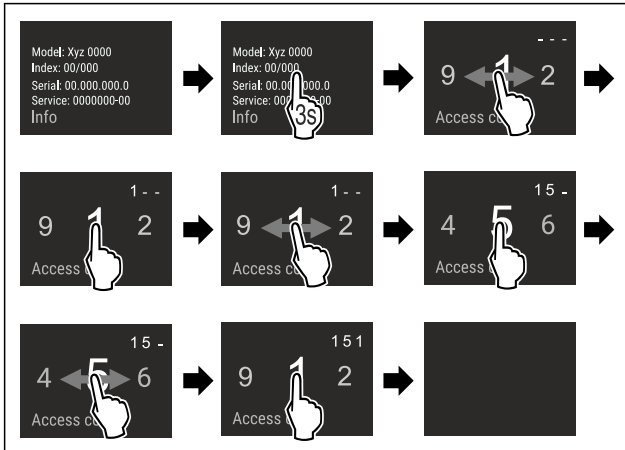

Fig. 4 Example illustration, access with numerical code 151

- ▶ Carry out action steps according to the illustration.
- ▷ The expanded menu is open.
- ▶ If necessary: Navigate to the desired function.

## 3.3 Sleep mode

If you do not touch the display for 1 minute, the display switches to sleep mode. In sleep mode, the display brightness is dimmed.

### 3.3.1 Ending sleep mode

- ▶ Touch the display briefly with your finger.
- ▷ Sleep mode is ended.

## 4 Putting into operation

### 4.1 Switching on appliance (first use)

Make sure that the following requirements are fulfilled:

- The appliance has been installed and connected in accordance with the installation instructions.
- All adhesive strips, adhesive and protective films and transport locks are removed from inside and on the appliance.
- All marketing leaflets are removed from the drawers.
- You are familiar with the functionality of the Touch & Swipe display. (see 3 Functionality of the Touch & Swipe display)

#### Switch on the appliance using the Touch & Swipe display:

- ▶ If the display is in sleep mode: Briefly touch the display.
- ▶ Carry out action steps according to the illustration.

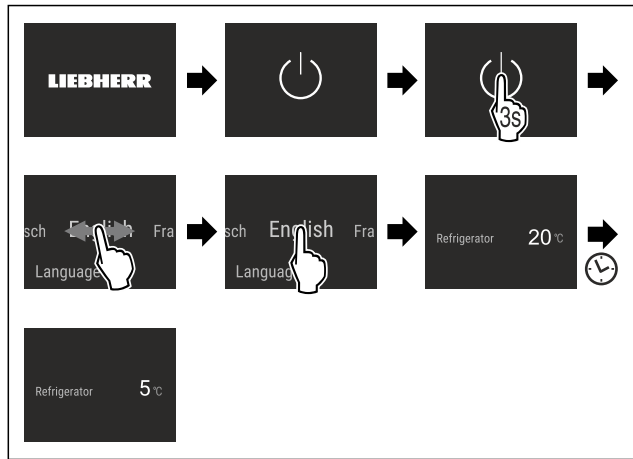

Fig. 5 Example illustration

- ▷ The status display appears.
- ▷ The appliance cools to the temperature set at the factory.
- ▷ The appliance starts in demo mode (status display with DEMO appears): If the appliance starts in demo mode, you can deactivate demo mode within the next 5 minutes. (see Demo mode)

#### More information:

- Start the SmartDevice for the first time. (see 1.3 Smart-Device) and (see WiFi)

#### Note

The manufacturer recommends:

- ▶ Stock with food: Wait for around 6 hours until the set temperature is reached.
- ▶ Observe the notes on storing food. (see 5.1 Information regarding storage)

#### Note

Accessories can be purchased from the Liebherr-Hausgeräte store at [home.liebherr.com/shop/de/deu/zubehor.html](http://home.liebherr.com/shop/de/deu/zubehor.html).

## 5 Storage

### 5.1 Information regarding storage



#### WARNING

Risk of fire

- ▶ Do not use any electrical appliances in the food area of the appliance unless recommended by the manufacturer.

#### Note

The energy consumption increases and the cooling power goes down if ventilation is not sufficient.

- ▶ Always keep air slots clear.

Observe the following specifications for storage:

- Keep the air vents on the inside of the rear wall free.
- Keep the air vents on the fan free.
- Package or cover foods that readily take on or give off odours or taste in closed containers.
- Package raw meat or fish in clean, closed containers. This will prevent meat or fish from touching or dripping onto other food.
- Keep liquids in closed containers.
- Leave space between goods to ensure good air circulation.

## Saving energy

- Store food according to the instructions on the packaging.
- Always observe the best-before date indicated on the packaging.

### Note

Failure to follow these guidelines can lead to foodstuffs spoiling.

## 5.2 Fridge compartment

The air circulation in the appliance creates different temperature zones. You will find the different temperature zones in the appliance and equipment overview. (see 1.2 Overview of the appliance and equipment)

### 5.2.1 Arranging your food properly

- ▶ Upper area and door: Store butter, cheese, tinned food and tubes.
- ▶ Coldest temperature zone: Store perishable foods such as pre-cooked meals, meat and lunch meats.
- ▶ Bottom shelf: Store raw meat or fish.

## 5.3 EasyFresh

EasyFresh is great for non-packaged foods, such as fruit and vegetables.

The humidity in the compartment depends on the moisture content of the chilled goods placed in it, and also depends on how often the compartment is opened. You can regulate the humidity level. (see 8.6 Adjusting the moisture levels)

### 5.3.1 Arranging your food properly

- ▶ Store unpackaged fruit and vegetables. If the humidity is too high:
- ▶ Regulate the humidity. (see 8.6 Adjusting the moisture levels)

## 5.4 Storage times

Refer to the specified storage times as a guide.

In the case of foods with a minimum shelf life, the date indicated on the packaging still applies.

### 5.4.1 Fridge section

Always follow the best-before date stated on the packaging.

## 6 Saving energy

- Pay attention to good ventilation. Do not cover ventilation holes or grids.
- Always keep the fan air slits clear.
- Do not install the appliance in direct sunlight, next to an oven, radiator or similar.
- Energy consumption depends on the installation conditions, e.g. the ambient temperature (see 1.4 Appliance range of use) . A warmer ambient temperature can increase the energy consumption.
- Open the appliance for as short a time as possible.
- The lower the temperature is set the higher the energy consumption.
- Sort your food: [home.liebherr.com/food](http://home.liebherr.com/food).
- Keep all food properly packed and covered. This prevents frost from forming.
- Only take food out for as long as necessary so that it doesn't warm up too much.

- Inserting warm food: allow to cool down to room temperature first.
- For longer periods of absence, use HolidayMode (see HolidayMode) .

## 7 Controls

### 7.1 Controls and displays

#### 7.1.1 Status display

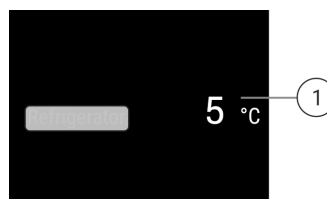





Fig. 6

(1) Temperature display of the fridge section

#### 7.1.2 Display symbols

Display symbols provide information on the current appliance status:

Symbol	Appliance status
	<b>Standby</b> The appliance or temperature zone is switched off.
	<b>Flashing number</b> Appliance is working. Temperature flashes until the set temperature is reached.
	<b>Flashing symbol</b> Appliance is working. Setting is made.

## 7.2 Appliance functions

### 7.2.1 Notes on the appliance functions

The appliance functions are set at the factory so that your appliance is fully functional.

Before you alter, activate or deactivate the device functions, make sure that the following requirements are met:

- You have read and understood the descriptions of how the display works.
- You have familiarised yourself with the operating and display elements of your appliance.



### Turn off appliance

This setting turns off the whole appliance.

### Switching off the entire appliance





Fig. 7

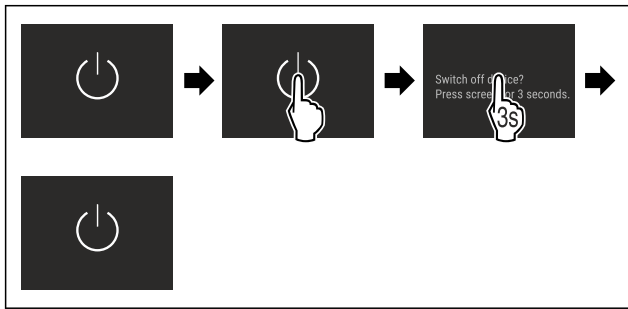

Fig. 8

- ▷ Off: Display goes black.



Use this function to connect your appliance to WiFi. You can then operate it via the SmartDevice app on a mobile device. You can also use this function to disconnect or reset the WiFi connection.

More information on the SmartDevice: (see 1.3 SmartDevice)

### Note

The SmartDevice function is not available in the following countries: Russia, Belarus, Kazakhstan.

### Establishing the WiFi connection for the first time

Make sure that the following requirements are fulfilled:

- You have installed the SmartDevice app (see [apps.home.liebherr.com](https://apps.home.liebherr.com)).
- Registration in the SmartDevice app is completed.



Fig. 9

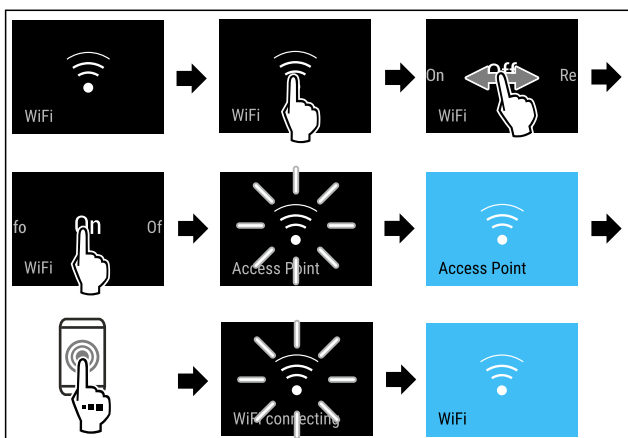

Fig. 10

- ▶ Carry out action steps according to the illustration.
- ▷ Connection is established.

### Disconnecting from the WiFi



Fig. 11

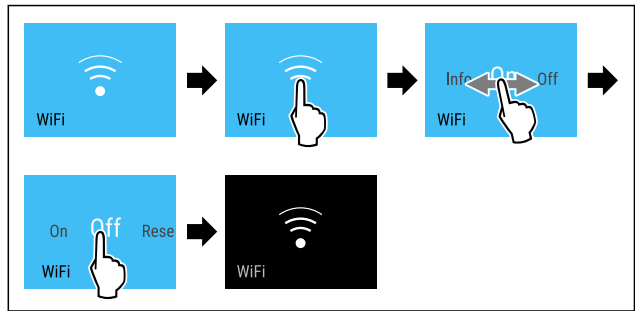

Fig. 12

- ▶ Carry out action steps according to the illustration.
- ▷ There is no connection.

### Resetting the WiFi connection



Fig. 13

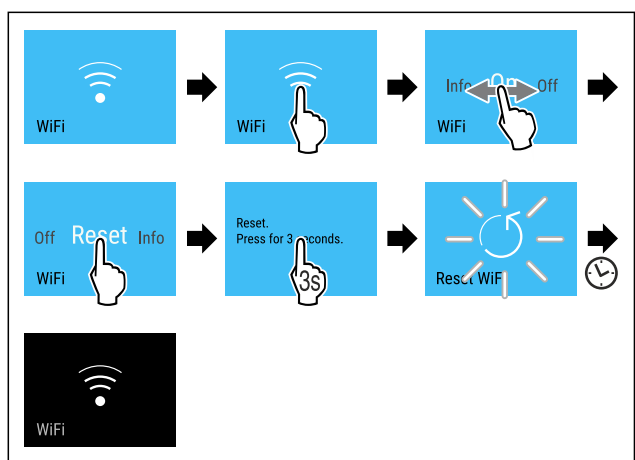

Fig. 14

- ▶ Carry out action steps according to the illustration.
- ▷ WiFi connection and other WiFi settings are reset to factory settings.

### Showing information about the WiFi connection



Fig. 15

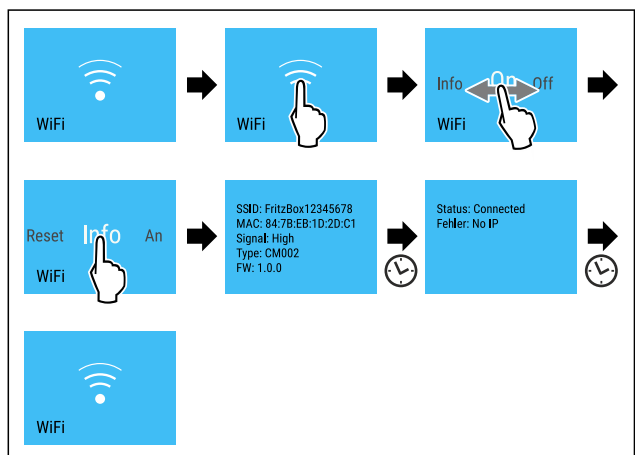

Fig. 16

- ▶ Carry out action steps according to the illustration.

# Controls

## 5 °C Temperature

Use this function to set the temperature.

The temperature depends on the following factors:

- How often the door is opened
- How long the door is open for
- The room temperature of the installation site
- The type, temperature and amount of food

Temperature zone	Recommended setting
------------------	---------------------

5 °C Fridge compartment	5 °C
----------------------------	------

### Setting temperature

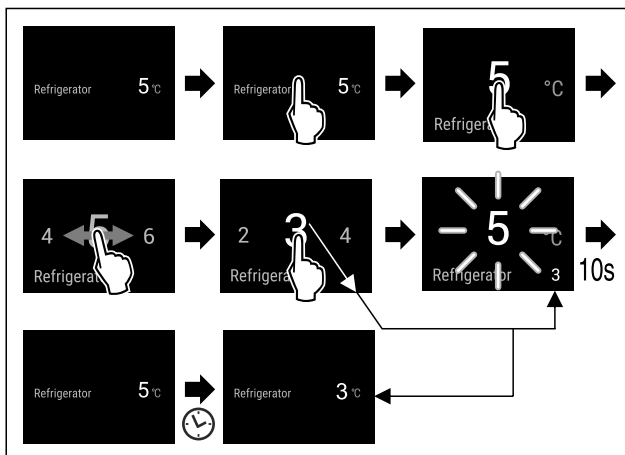

Fig. 17

- ▶ Carry out action steps according to the illustration.
- ▷ Temperature is set.

## °C/°F Temperature unit

Use this function to set the temperature unit. You can set degrees Celsius or degrees Fahrenheit as the temperature unit.

### Setting the temperature unit



Fig. 18

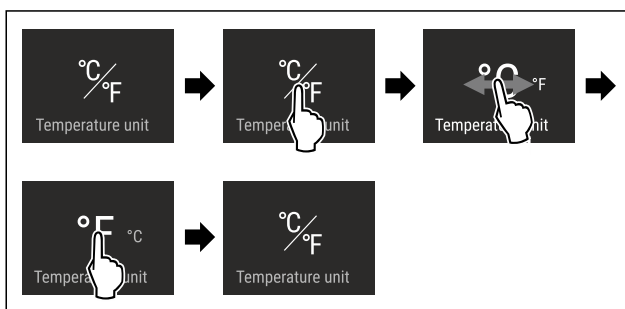

Fig. 19 Example illustration: Switch from degrees Celsius to degrees Fahrenheit.

- ▶ Carry out action steps according to the illustration.
- ▷ The temperature unit is set.

## D1 D-Value

Use this function to set the D-Value.

The D-Value specifies whether you are operating your fridge section with a dry rear wall or without a dry rear wall. The rear wall is installed in the appliance as delivered. The D-Value is pre-set to D1.

You can remove the rear wall for cleaning. In order to operate the appliance without a rear wall, you must set the D-Value to D2.

### Note

The declared energy consumption was determined without a dry rear wall. The appliance is fully functional with a dry rear wall but its energy consumption will be slightly higher. Liebherr recommends:

- ▶ Operate the appliance with a dry rear wall in order to prevent visible condensate and the food freezing.

### Setting the D-Value



Fig. 20

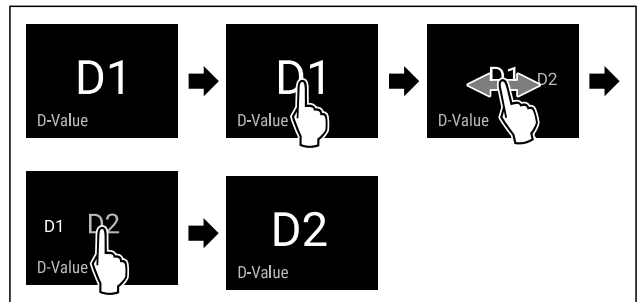

Fig. 21 Example illustration: Switch from D1 to D2.

- ▶ Carry out action steps according to the illustration.
- ▷ The D-Value is set.

## SuperCool

This function selects the lowest cooling temperature. This gives you colder storage temperatures.

This function is relevant to the fridge section Fig. 1 (A)

Use:

- Cool large amounts of food quickly.

### Activating/deactivating the function

- ▶ Using the fridge section: activate the function when you add the goods.
- ▶ Activating/deactivating.

-or-

- ▶ Activate/deactivate using the SmartDevice app.

The function automatically turns off. The appliance goes back to normal mode. The temperature adjusts itself to the set level.

## PowerCool

You can use this function to activate or deactivate PowerCool. PowerCool ensures optimised temperature layers for cooling your food.

The function applies to the fridge section.

Application:

- At higher room temperatures (as of approx. 35 °C)
- At high humidity, e.g. on summer days
- When storing moist food, in order to prevent condensate forming in the interior

### Note

The fan may also run even if the function is deactivated. It therefore ensures even temperature distribution in the appliance.

If the function is active, the device operates at higher power. As a result, the device's operating noise may be temporarily louder and energy consumption will increase.

### Activating PowerCool

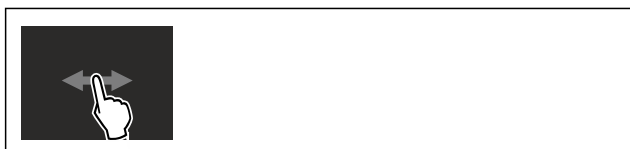

Fig. 22

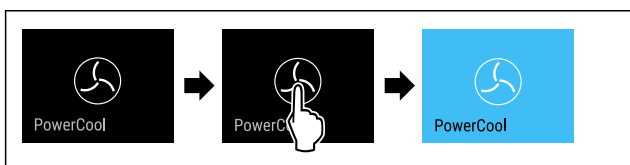

Fig. 23

- ▶ Carry out action steps according to the illustration.
- ▷ PowerCool is activated.
- ▷ The appliance's energy consumption increases slightly.

### Deactivating PowerCool



Fig. 24

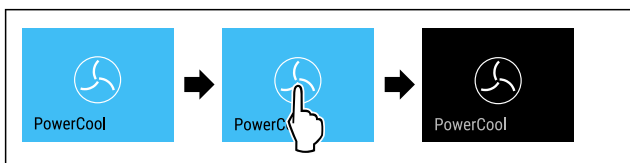

Fig. 25

- ▶ Carry out action steps according to the illustration.
- ▷ PowerCool is deactivated.

## HolidayMode

This function minimises the energy consumption during an extended absence. The temperature of the refrigerator compartment is set to 15 °C and this is displayed on the status screen when the temperature has been reached.

Use:

- Save energy if you plan to be away for a while.
- Avoid coming home to bad smells and mould.

### Activating/deactivating the function

- ▶ Empty everything from the fridge section.
- ▶ Activating/deactivating .
- ▷ On: Fridge temperature is raised.
- ▷ Off: the previously set temperature is restored.

## SabbathMode

You can use this function to activate or deactivate SabbathMode. If you activate this function, some electronic functions are switched off. As a result, your device meets the religious requirements for Jewish holidays such as Sabbath and complies with STAR-K Kosher certification.

Device status when SabbathMode is active
The status display shows SabbathMode permanently.
All functions on the display are locked except for the <b>Deactivate SabbathMode function</b> .
Active functions remain active.
The display remains bright when you close the door.
The interior lighting is deactivated.
Reminders are not implemented. The set time interval stops.
Reminders and warnings are not displayed.
There is no door alarm.
There is no temperature alarm.
The defrosting cycle operates only for the specified time, without considering the device consumption.
After a power failure, the device returns to SabbathMode.

Device status

### Note

This appliance has certification from the "Institute for Science and Halacha". ([www.machonhalacha.co.il](http://www.machonhalacha.co.il))

You can find a list of STAR-K-certified appliances at [www.star-k.org/appliances](http://www.star-k.org/appliances).

### Activating SabbathMode



### WARNING

Danger of food poisoning from spoiled food!

If you have SabbathMode activated and a power failure occurs, no message appears in the status display about the power failure. Once the power is restored, the appliance continues to operate in SabbathMode. The power failure may mean that food spoils and the consumption of this food could lead to food poisoning.

After a power failure:

- ▶ Do not consume food that was frozen and has thawed out.



Fig. 26

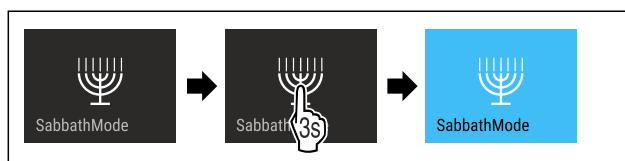

Fig. 27

- ▶ Carry out action steps according to the illustration.
- ▷ SabbathMode is activated.
- ▷ The status display shows SabbathMode permanently.

# Controls

## Deactivating SabbathMode

The SabbathMode is automatically deactivated after 80 hours. However, you can also deactivate SabbathMode manually at any time:

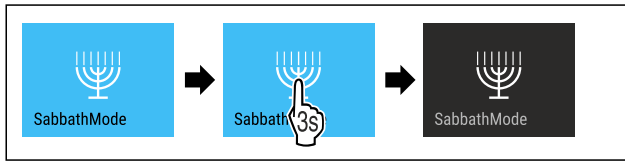

Fig. 28

- ▶ Carry out action steps according to the illustration.
- ▷ SabbathMode is deactivated.



## EnergySaver

You can use this function to activate or deactivate Energy saving mode. If energy saving mode is activated, the energy consumption decreases and the temperature in the device increases. The food remains fresh, but the shelf life is shortened.

Temperature zone	Recommended setting (see Temperature)	Temperature with active EnergySaver
5 °C Fridge section	5 °C	7 °C

Temperatures

### Activating EnergySaver



Fig. 29

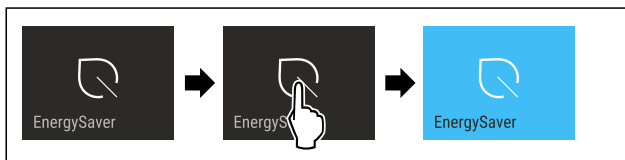

Fig. 30

- ▶ Carry out action steps according to the illustration.
- ▷ Energy saving mode is activated.

### Deactivating EnergySaver



Fig. 31

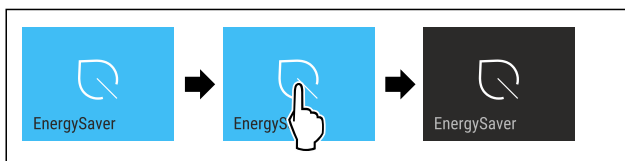

Fig. 32

- ▶ Carry out action steps according to the illustration.
- ▷ Energy saving mode is deactivated.



## CleaningMode

You can use this function to activate or deactivate CleaningMode. CleaningMode enables the appliance to be cleaned conveniently.

This setting applies to the fridge section.

Application:

- Clean the fridge section. (see 9.4 Cleaning the appliance)

Device status when CleaningMode is active
The status display shows CleaningMode permanently.
The fridge section is switched off.
The reminders and warnings are not displayed. No signal tone sounds.

Device status

### Activating CleaningMode

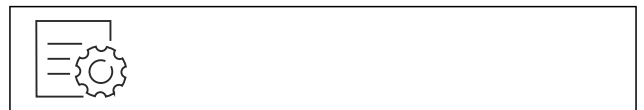

Fig. 33



Fig. 34

- ▶ Carry out action steps according to the illustration.
- ▷ CleaningMode is activated.
- ▷ The status display shows CleaningMode permanently.

### Deactivating CleaningMode

CleaningMode is deactivated automatically after 60 minutes. However, you can also deactivate CleaningMode manually at any time:

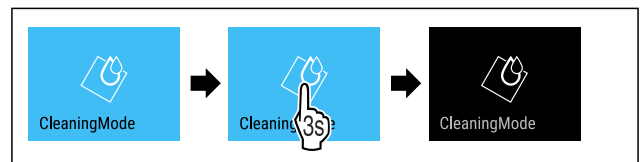

Fig. 35

- ▶ Carry out action steps according to the illustration.
- ▷ CleaningMode is deactivated.
- ▷ The appliance cools to the temperature set previously.



## Display brightness

Use this function to set the display brightness in stages.

You can select the following brightness levels:

- 40 %
- 60 %
- 80 %
- 100 % (pre-setting)

### Setting the display brightness



Fig. 36

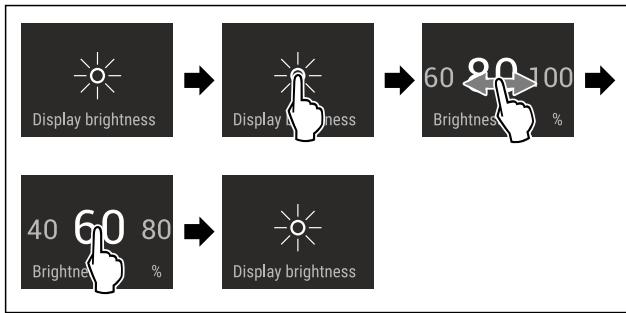

Fig. 37 Example illustration: Switch from 80 % to 60 %.

- ▶ Carry out action steps according to the illustration.
- ▷ The display brightness is set.

## Door alarm

Set the time before the door alarm (see Close the door) sounds.

The options are as follows:

- 1 min
- 2 min
- 3 min
- Off

### Choose the setting

- ▶ Set the time (see 7.3 Fault messages) .

## Input lock

You can use this function to activate or deactivate the input lock. The input lock prevents the appliance being operated accidentally, e.g. by children.

Application:

- Avoid unintentional modification of functions.
- Avoid unintentional switching off of the device.
- Avoid unintentional temperature setting.

### Activating the input lock

If you activate the input lock, you can continue to navigate in the menus but you cannot select or change other functions.



Fig. 38

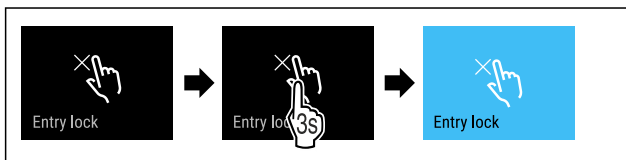

Fig. 39

- ▶ Carry out action steps according to the illustration.
- ▷ Input lock is activated.

### Deactivating the input lock

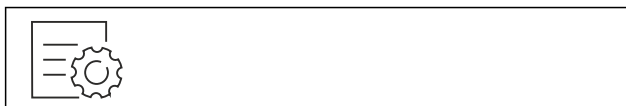

Fig. 40

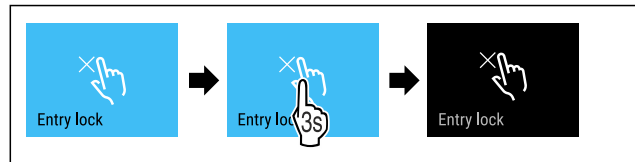

Fig. 41

- ▶ Carry out action steps according to the illustration.
- ▷ Input lock is deactivated.

## Language

Use this function to set the display language.

You can select the following languages:

- Deutsch
- English
- Français
- Español
- Italiano
- Nederlands
- Čeština
- Polski
- Português
- Русский
- 温度单位

### Setting the language

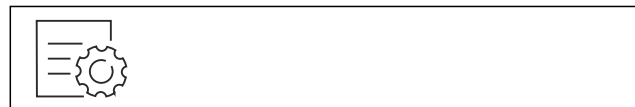

Fig. 42

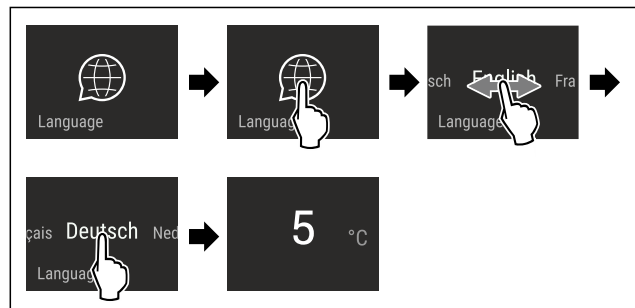

Fig. 43 Example illustration depending on the language and temperature

- ▶ Carry out action steps according to the illustration.
- ▷ The language is set.
- ▷ The display returns to the status display.

## Info

This setting allows the appliance information to be read out as well as access to the customer menu.

It provides the following information:

- Model name
- Index
- Serial number
- Service number

### Show appliance data

- ▶ Swipe in the display until Settings  appears.
- ▶ Confirm the display.
- ▶ Swipe in the display until About appears.

# Controls

- ▶ Read the appliance info.



## Reminder

Reminders are given out acoustically by a beep and visually by a symbol in the display. The signal gets louder until the alert stops.



## Replace FreshAir active carbon filter

This message appears when the air filter needs replacing.

- ▶ Change the air filter every six months.
- ▶ Confirm the message with OK.
- ▷ The service interval resets.
- ▷ The air filter guarantees the air quality in the fridge.

## Activating the setting

- ▶ Activating/deactivating .



## Demo mode

Demo mode is a special feature for dealers who want to demonstrate appliance features. If you activate demo mode, all refrigeration functions are deactivated.

If you switch on your appliance and “Demo” appears in the status display, then demo mode is already activated.

If you activate and then deactivate demo mode, the appliance will be reset to factory defaults. (see Resetting to factory settings)

## Activating demo mode



Fig. 44

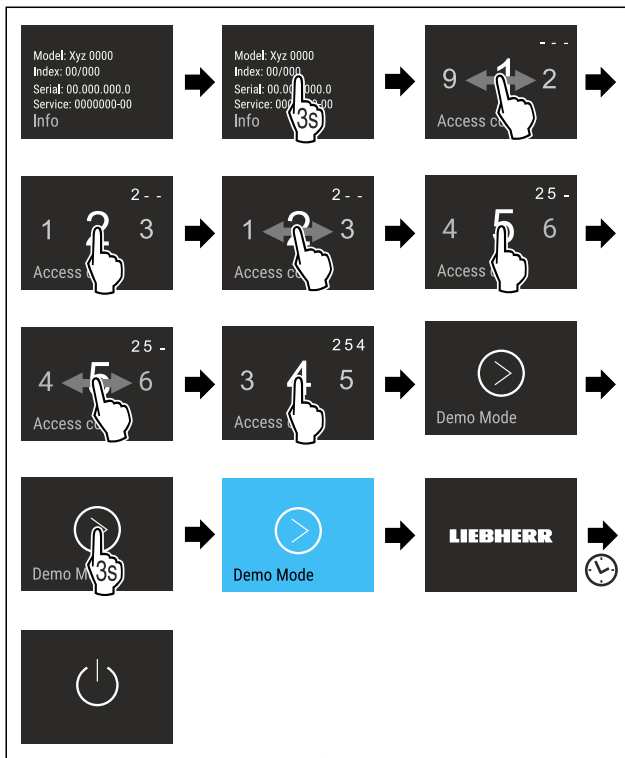

Fig. 45

- ▶ Carry out action steps according to the illustration.
- ▷ Demo mode is activated.
- ▷ Appliance is switched off.

- ▶ Switch on the appliance. (see 4.1 Switching on appliance (first use))

- ▷ “DEMO” appears in the status display.

## Deactivating demo mode



Fig. 46

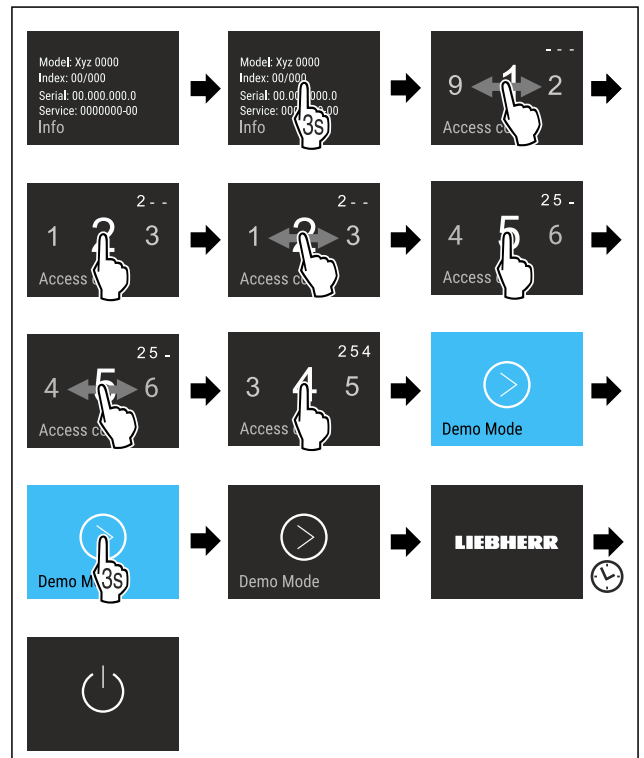

Fig. 47

- ▶ Carry out action steps according to the illustration.
- ▷ Demo mode is deactivated.
- ▷ Appliance is switched off.
- ▶ Switch on the appliance. (see 4.1 Switching on appliance (first use))
- ▷ Appliance is reset to factory settings.



## Resetting to factory settings

Use this function to reset all settings to factory defaults. All settings you have made so far are reset to their original settings.

## Performing a reset

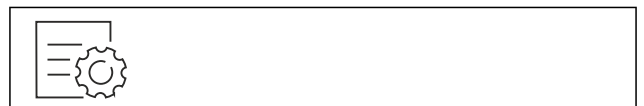

Fig. 48

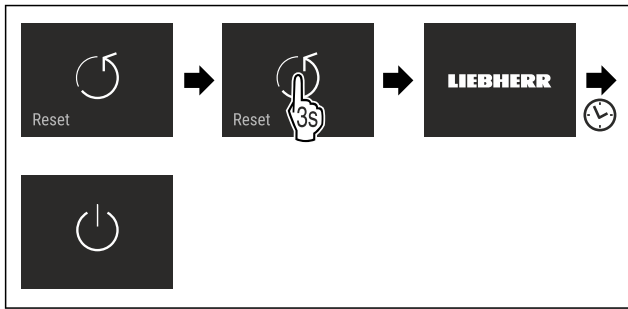

Fig. 49

- ▶ Carry out action steps according to the illustration.
- ▷ Device is reset.
- ▷ Device is switched off.
- ▶ Restart the device. (see 4.1 Switching on appliance (first use))

## 7.3 Fault messages

Fault messages appear in the display. There are two categories of fault message:

Category	Meaning
Message	Reminder of general procedures. You can carry out these procedures to eliminate the message.
Warning	Appears when there are malfunctions. A signal sounds in addition to the display. The signal becomes louder until you acknowledge by tapping the display. You can eliminate simple defects yourself. For more serious defects, you must contact customer service.

### 7.3.1 Warnings



#### Close the door

This message appears if the door is open for too long.

You can set how long it takes for this message to appear .

- ▶ Stop alarm: Confirm the message.

-or-

- ▶ Close the door.



#### Error

This message appears if there is a fault with the appliance. An appliance component indicates a fault.

- ▶ Open the door.
- ▶ Note down the fault code.
- ▶ Confirm the message.
- ▷ The signal tone stops.
- ▷ The status display appears.
- ▶ Close the door.
- ▶ Contact customer service. (see 10.4 Customer Service)

## 8 Features

### 8.1 Shelves

#### 8.1.1 Adjusting/removing the shelves

The shelves are prevented from being pulled out accidentally by pull out stops.

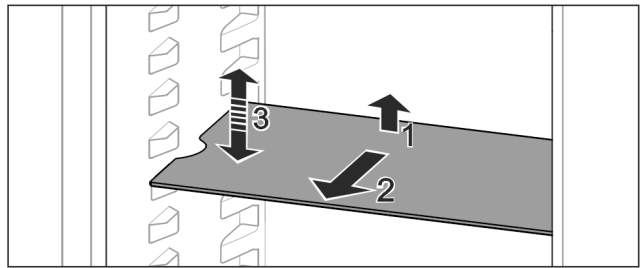

Fig. 50

- ▶ Lift the shelf and pull forward.
- ▷ Line up the side runner.
- ▶ Adjust the height of the shelf: Lift or lower it to the desired height and slide it in.

-or-

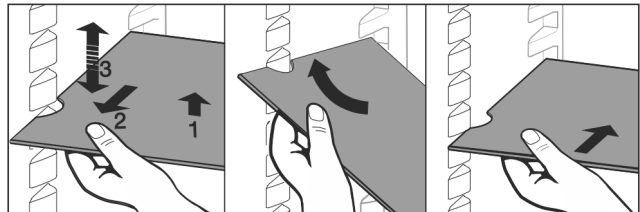

Fig. 51

- ▶ Remove the shelf completely: Pull it out to the front.

- ▶ Easier removal: Set the shelf at an angle.
- ▶ Insert the shelf again: Slide it in all the way.
- ▷ The pull-out stoppers point downwards.
- ▷ The pull-out stoppers are behind the front support.

You can also remove the shelf above the EasyFresh compartments.

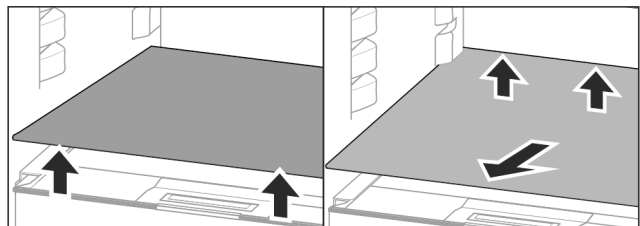

Fig. 52

Removing the shelf:

- ▶ Lift the shelf at the front and back.
- ▶ Pull it out towards you.

Do not store any goods on the compartment cover below!

Inserting the shelf:

- ▶ Place the shelf at an angle, sloping down towards the back.
- ▷ The pull-out stoppers point downwards.
- ▶ Slide the shelf into place.

## 8.2 Dividing shelf

### 8.2.1 Using the dividing shelf

The shelves are prevented from being pulled out accidentally by pull out stops.

# Features

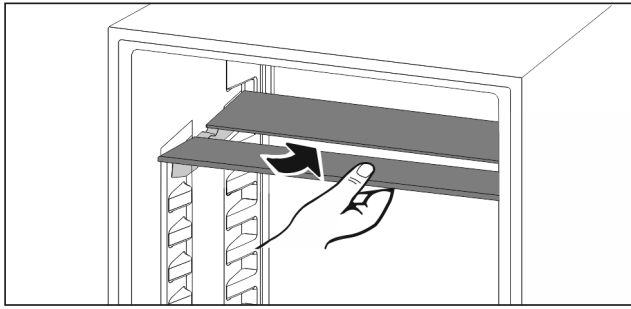

Fig. 53

- ▶ Push the dividing shelf underneath as shown.

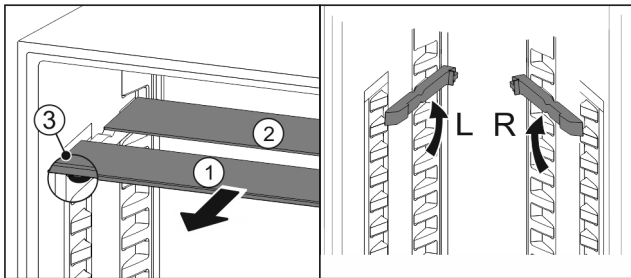

Fig. 54

### Adjusting the height:

- ▶ Pull the glass panels out Fig. 54 (1) from the front, one at a time.
- ▶ Release the support rails and click in at the height you want.
- ▶ Slide in the glass panels one at a time.
- ▷ Flat pull-out stoppers at the front, right behind the support rails.
- ▷ High pull-out stoppers at the back.

### Using both shelves:

- ▶ Hold the glass panel with one hand and pull it to the front.
- ▷ The glass panel Fig. 54 (1) and trim strip are at the front.
- ▷ The stops Fig. 54 (3) point down.

## 8.3 VarioSafe

The VarioSafe offers space in the refrigerator compartment for small groceries, packages, tubes and jars, for example.

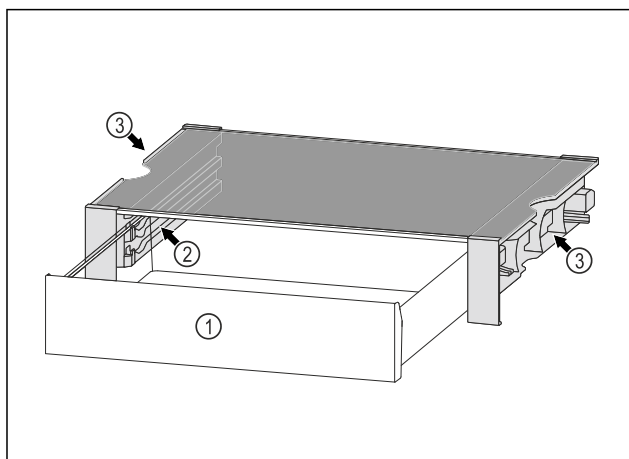

Fig. 55

- (1) VarioSafe drawer
- (2) Side panels with ribs for VarioSafe drawer
- (3) Recesses on the left and right side panel

### 8.3.1 Inserting the VarioSafe

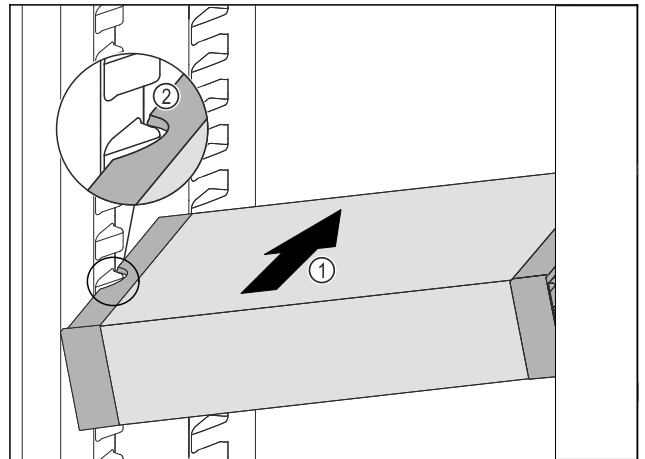

Fig. 56

- ▶ Insert the VarioSafe into the fridge section at an angle Fig. 56 (1) until the recesses in the side Fig. 56 (2) of the VarioSafe are at the level of the support rib in the fridge section.

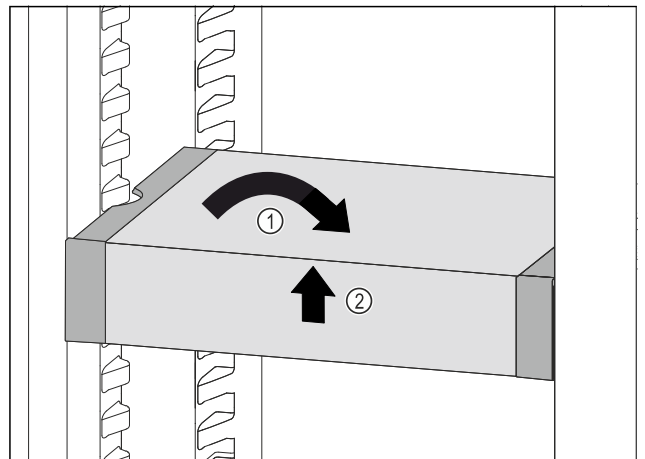

Fig. 57

- ▶ Set VarioSafe straight. Fig. 57 (1)
- ▶ Lift VarioSafe at the front. Fig. 57 (2)

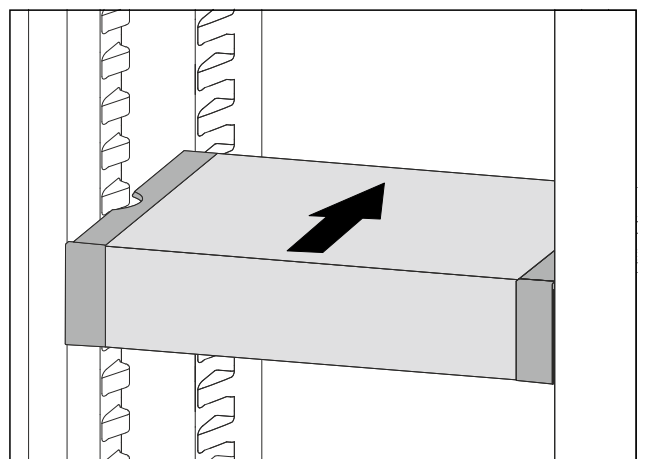

Fig. 58

- ▶ Lift VarioSafe up toward the front.
- ▶ Push VarioSafe in to the rear.
- ▶ Lower VarioSafe.
- ▷ VarioSafe audibly engages.
- ▷ VarioSafe is inserted.



## 8.3.2 Repositioning the VarioSafe

You can move the VarioSafe as a whole in the refrigerator compartment.

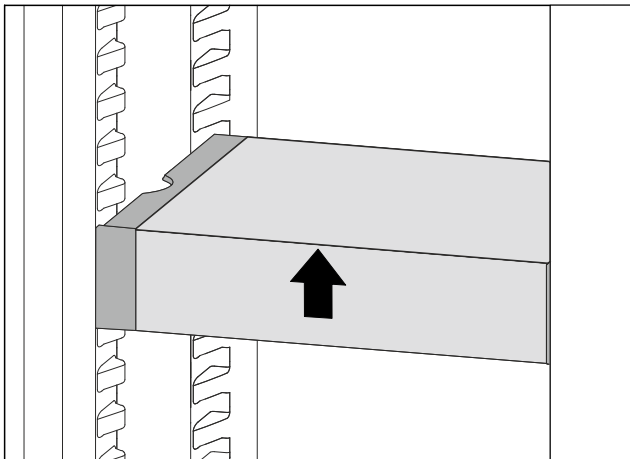

Fig. 59

- ▶ Lift VarioSafe at the front.

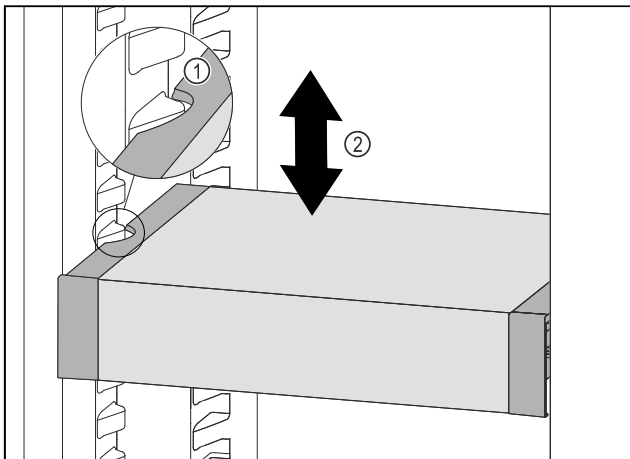

Fig. 60

- ▶ Pull VarioSafe forwards until the recesses in the side of the VarioSafe are at the level of the support rib in the refrigerator compartment. Fig. 60 (1)
- ▶ Move VarioSafe up or down in the refrigerator compartment until the desired height is reached. Fig. 60 (2)

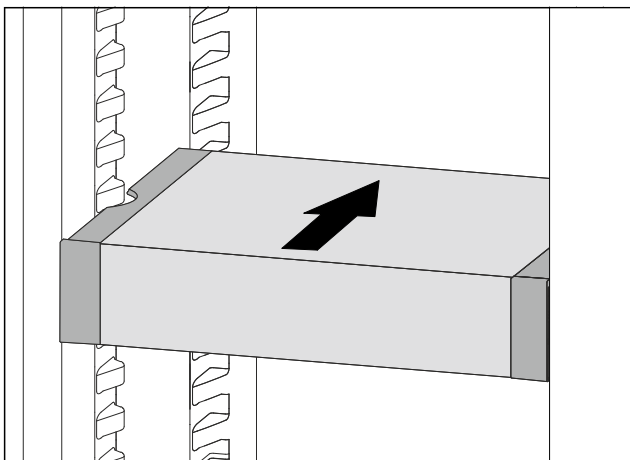

Fig. 61

- ▶ Lift VarioSafe at the front.
- ▶ Push VarioSafe in to the rear.
- ▷ VarioSafe audibly engages.
- ▷ VarioSafe is offset in height.

## 8.3.3 Moving the VarioSafe drawer

You can use the VarioSafe drawer at two different heights. If you would like to store taller foodstuffs in the VarioSafe drawer, slide the VarioSafe drawer in on the bottom rib. If you would like to store smaller foodstuffs in the VarioSafe drawer, slide the VarioSafe drawer in on the top rib.

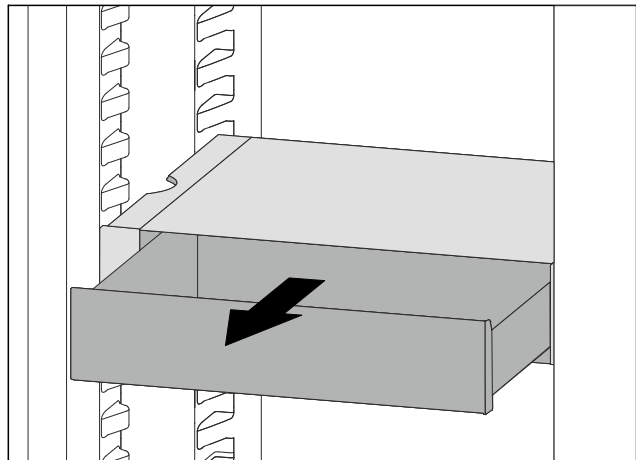

Fig. 62

- ▶ Pull out the VarioSafe drawer as far as it will go.
- ▶ Lift the VarioSafe drawer up at the front.
- ▶ Remove the VarioSafe drawer to the front.

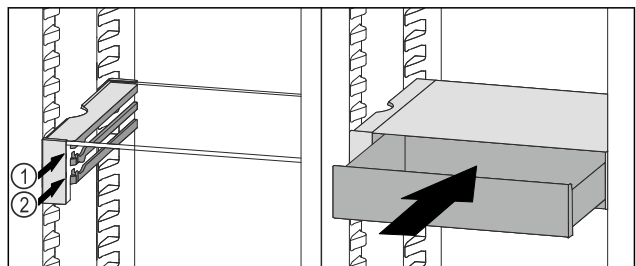

Fig. 63

- ▶ Lift the VarioSafe drawer up at the front.
- ▶ Place the VarioSafe drawer behind the stoppers on desired rib Fig. 63 (1) or Fig. 63 (2).
- ▷ VarioSafe drawer is offset in height.

## 8.3.4 Removing the VarioSafe

You can remove the VarioSafe as a whole.

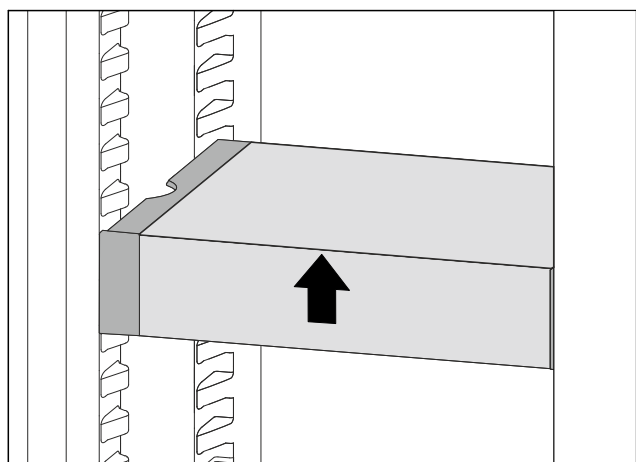

Fig. 64

- ▶ Lift VarioSafe at the front.

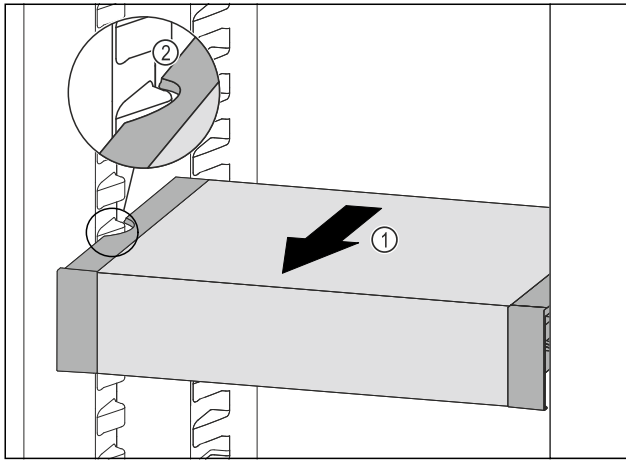

Fig. 65

- ▶ Pull VarioSafe forwards Fig. 65 (1) until the recesses in the side of the VarioSafe are at the level of the support rib in the fridge section. Fig. 65 (2)

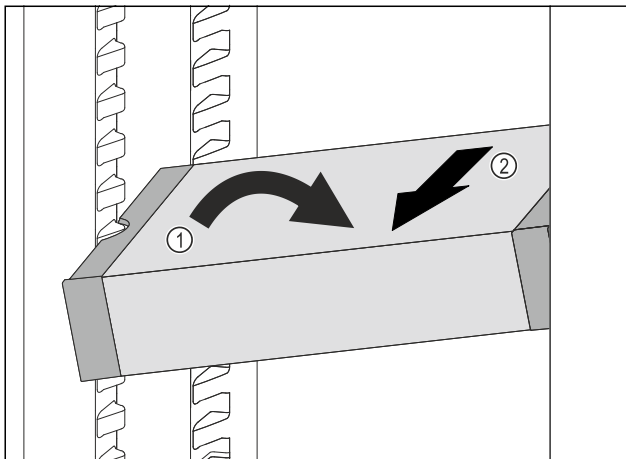

Fig. 66

- ▶ Set VarioSafe in refrigerator compartment at an angle. Fig. 66 (1)
- ▶ Take VarioSafe out to the front. Fig. 66 (2)
- ▷ VarioSafe is removed.

### 8.3.5 Disassembling the VarioSafe

You can disassemble the VarioSafe into its individual parts if you want to clean the VarioSafe or if you need to install or remove parts.

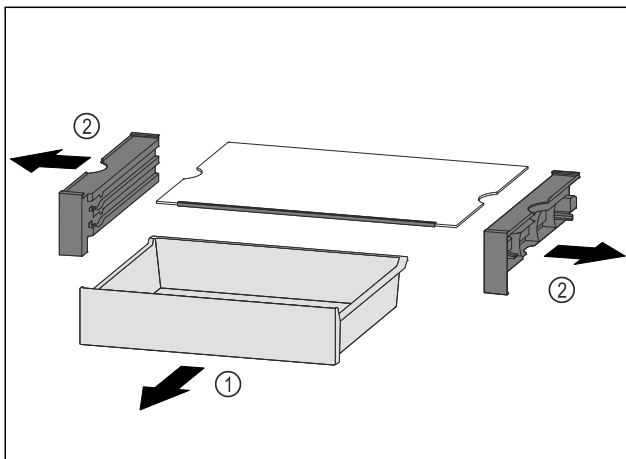

Fig. 67

- ▶ Remove VarioSafe as a whole. (see 8.3.4 Removing the VarioSafe )
- ▶ Disassemble VarioSafe according to the illustration.

## 8.4 Drawers

You can remove the drawers for cleaning.

The way to remove/insert the drawers varies depending on the pull-out system. Your appliance can contain various pull-out systems.

### Note

The energy consumption increases and the cooling power goes down if ventilation is not sufficient.

- ▶ Always leave the fan air vents clear on the back wall!

### 8.4.1 Drawer on rails

#### Removing drawer

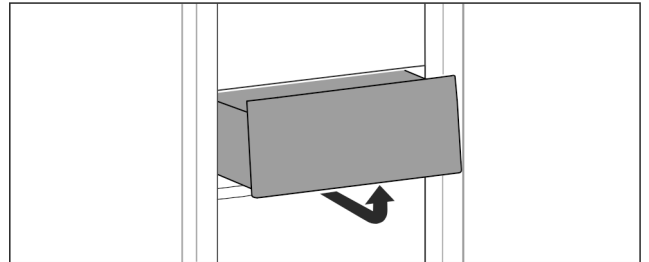

Fig. 68

- ▶ Remove drawer as shown in the illustration.

#### Inserting drawer

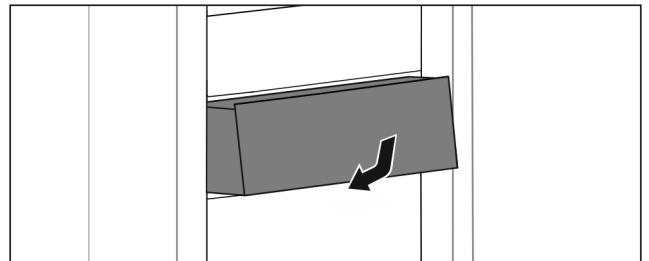

Fig. 69

- ▶ Insert drawer as shown in the illustration.

### 8.4.2 Drawer on telescopic rails

The drawer runs on extendible rails (telescopic rails). There are fully extendible telescopic rails and telescopic rails with partial pull-out. Drawers which are fully extendible can be pulled out fully from the appliance. Drawers with partial pull-out cannot be removed fully from the appliance. The system in your appliance depends on the type of appliance.

#### Partial pull-out fridge compartment

#### Removing drawer

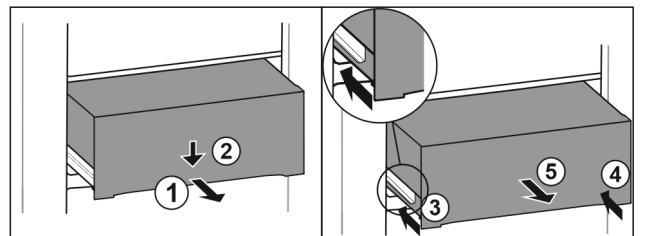

Fig. 70

- ▶ Pull out drawer half-way. Fig. 70 (1)
- ▶ Push the drawer down at the front. Fig. 70 (2)
- ▶ Push the left rail in by about 2 cm. Fig. 70 (3)
- ▶ Push the right rail in by about 2 cm. Fig. 70 (4)
- ▶ Remove drawer to the front. Fig. 70 (5)

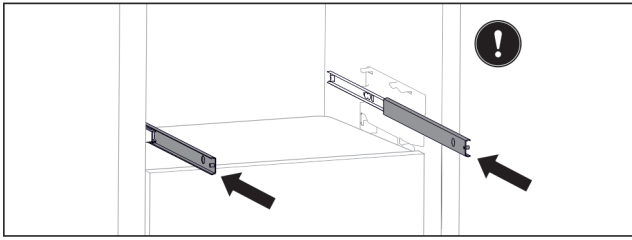

Fig. 71

If the rails are not yet fully inserted after removing the drawer:

- ▶ Push rails in completely.

### Inserting drawer

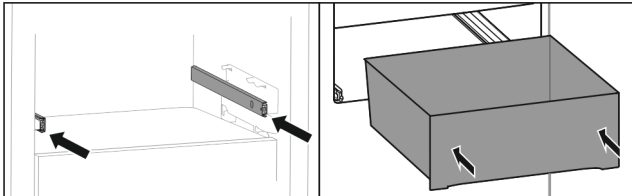

Fig. 72

- ▶ Slide rails in.
- ▶ Place drawer on rails.
- ▶ Slide in drawer to the back.

## 8.5 EasyFresh-Safe cover

You can remove the compartment cover for cleaning.

### 8.5.1 Removing the compartment cover

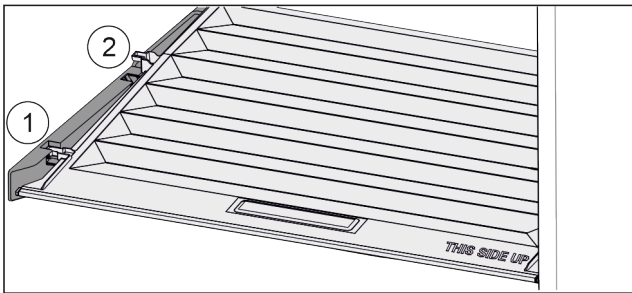

Fig. 73

When the drawers are removed:

- ▶ Pull the lid up at the front to the opening in the retaining parts Fig. 73 (1).
- ▶ Lift from the back and pull it up and out Fig. 73 (2).

### 8.5.2 Inserting the compartment cover

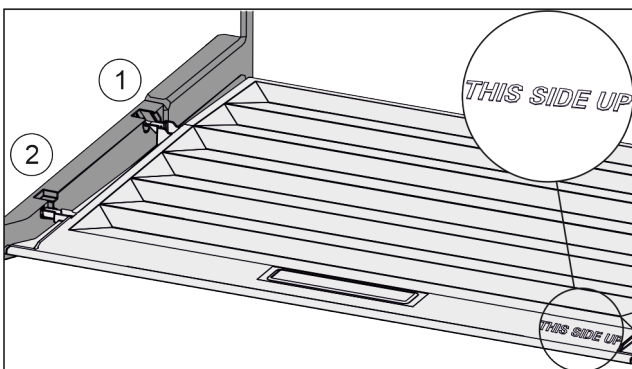

Fig. 74

If the text THIS SIDE UP points upwards:

- ▶ Insert the lip of the cover over the opening of the rear bracket Fig. 74 (1) and click into place Fig. 74 (2).
- ▶ Position the cover where you want it (see 8.6 Adjusting the moisture levels).

## 8.6 Adjusting the moisture levels

You can adjust the moisture in the drawer yourself by adjusting the compartment cover.

The compartment lid is attached to the drawer and can be hidden by a shelf or additional drawers.

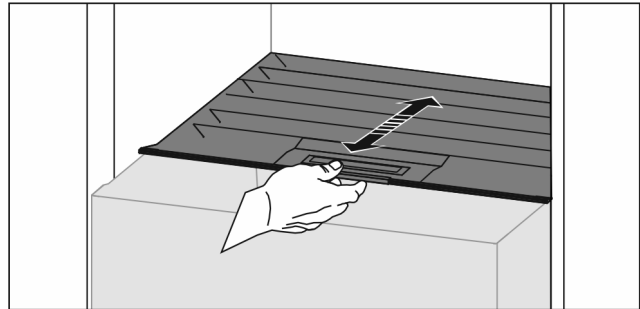

Fig. 75

### Low air humidity

- ▶ Open the drawer.
- ▶ Slide the compartment cover forwards.
- ▷ With the drawer closed: Gap between the cover and the compartment.
- ▷ The air moisture in the Safe decreases.

### High air moisture

- ▶ Open the drawer.
- ▶ Slide the cover back.
- ▷ With the drawer closed: The cover seals the compartment.
- ▷ The air moisture in the Safe increases.
- If there is too much moisture in the compartment:
- ▶ Choose the setting "low air moisture".
- or-
- ▶ Remove any excess moisture with a cloth.

## 8.7 Glass shelves

You can remove the glass shelves under the drawers for cleaning.

### 8.7.1 Removing / inserting the glass shelf

Make sure that the following requirements are fulfilled:

- Glass shelf under the drawer: The drawer has been removed. (see 8.4 Drawers)

#### Removing glass shelf

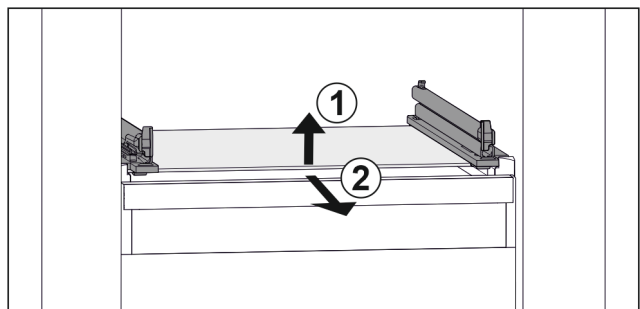

Fig. 76 Example illustration of glass shelf

- ▶ Lift glass shelf at the front. Fig. 76 (1)
- ▶ Take out glass shelf to the front. Fig. 76 (2)

# Maintenance

## Inserting glass shelf

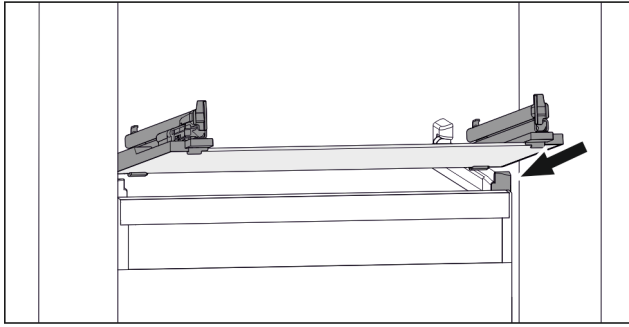

Fig. 77 Example illustration of glass shelf

- ▶ Position glass shelf at an angle behind the stoppers. (see Fig. 77)
- ▶ Lower glass shelf.
- ▶ Slide in glass shelf to the back.

## 8.8 Butter dish

### 8.8.1 Opening/closing the butter dish

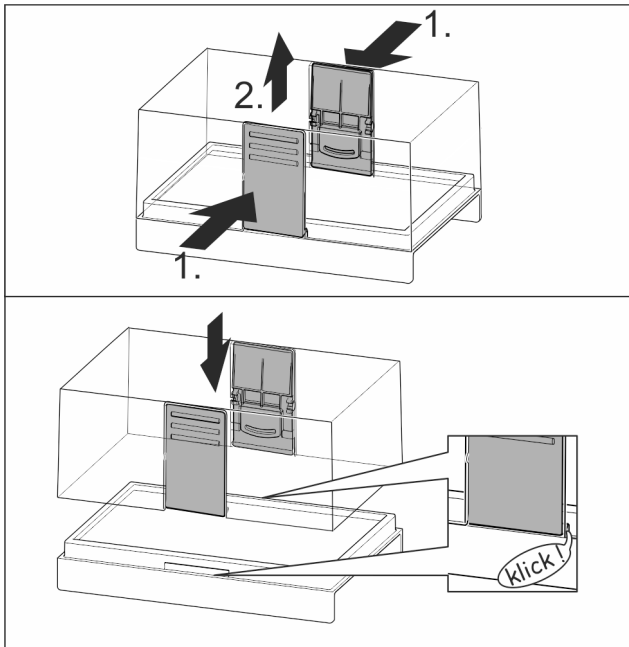

Fig. 78

### 8.8.2 Dismantling the butter dish

You can take the butter dish apart for cleaning.

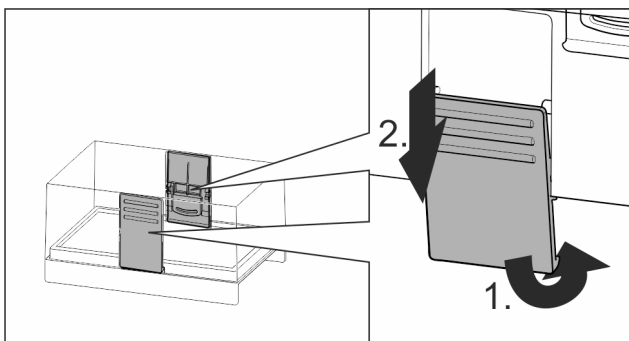

Fig. 79

- ▶ Disassembling the butter dish.

## 8.9 Egg rack

You can pull out and turn the egg rack. You can use both sides of the egg rack so you can label specifics like the purchase date.

### 8.9.1 Using the egg rack

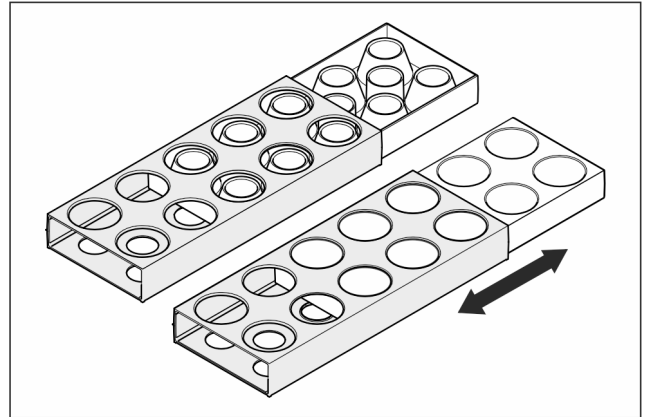

Fig. 80

- ▶ Top layer: for storing hen eggs.
- ▶ Bottom layer: for storing quail eggs.

## 8.10 Bottle holder

### 8.10.1 Using the bottle holder

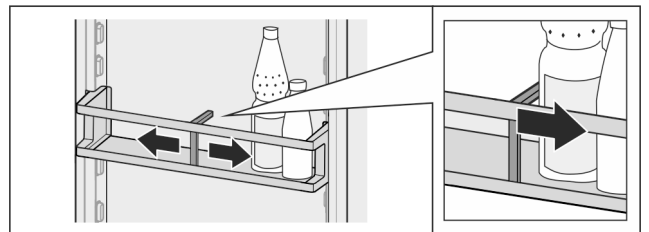

Fig. 81

- ▶ Push the bottle holder onto the bottles.
- ▷ The bottles are prevented from falling over.

### 8.10.2 Removing the bottle holder

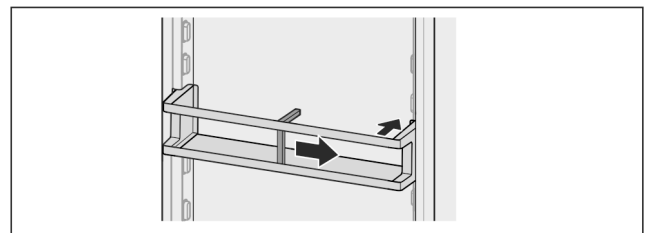

Fig. 82

- ▶ Move the bottle holder all the way to the right.
- ▶ Push the bottle holder to the back to remove.

# 9 Maintenance

## 9.1 FreshAir carbon filter

The FreshAir carbon filter is in the compartment above the fan.

It guarantees the best air quality.

- ☐ Replace the carbon filter every 6 months.

When the reminder is set, a message on the display prompts you to change it.

- ❑ The carbon filter can be disposed of with the regular household waste.

## Note

FreshAir activated charcoal filters can be purchased from the Liebherr-Hausgeräte store at [home.liebherr.com/shop/de/deu/zubehor.html](http://home.liebherr.com/shop/de/deu/zubehor.html).

### 9.1.1 Removing the FreshAir carbon filter

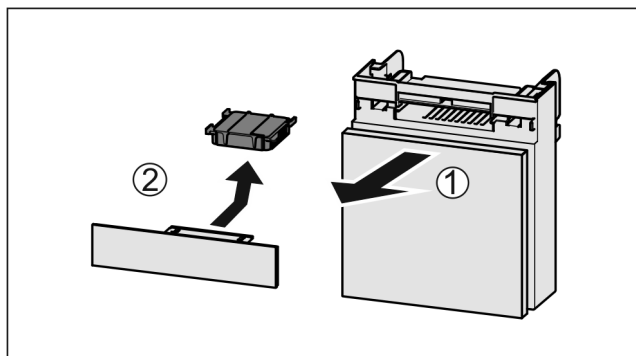

Fig. 83

- ▶ Pull out the compartment Fig. 83 (1).
- ▶ Remove the carbon filter Fig. 83 (2).

### 9.1.2 Inserting the FreshAir carbon filter

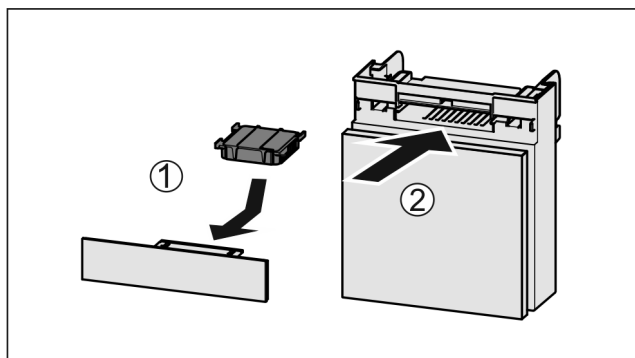

Fig. 84

- ▶ Insert the carbon filter as shown in the diagram Fig. 84 (1).
- ▷ The carbon filter clicks into place.  
If the carbon filter is pointing downwards:
- ▶ Push the compartment in Fig. 84 (2).
- ▷ The carbon filter is now ready for use.

## 9.2 Disassembling / assembling pull-out systems

### 9.2.1 Notes on disassembly

You can disassemble some of the pull-out systems for cleaning. Your appliance can contain a variety of pull-out systems.

The following pull-out systems can be disassembled or cannot be disassembled:

Pull-out system	can be disassembled / cannot be disassembled
Drawer on rails	cannot be disassembled
Partial pull-out fridge compartment	cannot be disassembled

## 9.3 Defrosting the appliance



### WARNING

Improper defrosting of the appliance!  
Injuries and damage.

- ▶ Do not use mechanical equipment or other methods to speed up the defrosting process other than those recommended by the manufacturer.
- ▶ Do not use electrical heating or steam-cleaning appliances, naked flames or defroster sprays to defrost.
- ▶ Do not use sharp objects to remove ice.

Defrosting is performed automatically. The water from the thawing process drains through the outlet and evaporates.

A layer of frost or ice can form briefly due to the energy-optimised control of the device.

- ▶ Clean the drain opening regularly (see 9.4 Cleaning the appliance).

## 9.4 Cleaning the appliance

### 9.4.1 Ready



### WARNING

Danger of electric shock!

- ▶ Remove the refrigerator connector or interrupt the power supply.



### WARNING

Risk of fire

- ▶ Do not damage the refrigeration circuit.

- ▶ Empty the appliance.
- ▶ Remove mains connector.
- or-
- ▶ Activate CleaningMode.

### 9.4.2 Clean the housing

### NOTICE

Improper cleaning!  
Damage to the appliance.

- ▶ Only use soft cleaning cloths and ph-neutral all-purpose cleaners.
- ▶ Do not use abrasive sponges or steel wool which may cause scratches.
- ▶ Do not use any sharp or abrasive cleaning agents, nor any that contain sand, chloride or acid.



### WARNING

Risk of injury and damage as a result of hot steam!

Hot steam can lead to burns and can damage the surfaces.

- ▶ Do not use any steam cleaners!
- ▶ Wipe the housing down with soft, clean cloth. If very dirty, use lukewarm water with a neutral cleaner. Glass surfaces can also be cleaned with glass cleaner.

# Customer help

## 9.4.3 Cleaning the interior

### NOTICE

Improper cleaning!

Damage to the appliance.

- ▶ Only use soft cleaning cloths and ph-neutral all-purpose cleaners.
- ▶ Do not use abrasive sponges or steel wool which may cause scratches.
- ▶ Do not use any sharp or abrasive cleaning agents, nor any that contain sand, chloride or acid.

- ▶ Plastic surfaces: clean by hand with a soft clean cloth, lukewarm water and a little detergent.
- ▶ Metal surfaces: clean by hand with a soft clean cloth, lukewarm water and a little detergent.
- ▶ Drain hole: remove deposits using a thin item (for example a cotton bud).

## 9.4.4 Clean the components

### NOTICE

Improper cleaning!

Damage to the appliance.

- ▶ Only use soft cleaning cloths and ph-neutral all-purpose cleaners.
- ▶ Do not use abrasive sponges or steel wool which may cause scratches.
- ▶ Do not use any sharp or abrasive cleaning agents, nor any that contain sand, chloride or acid.

**Clean with a soft, clean cloth, lukewarm water and some detergent:**

- Door rack
- VarioSafe
- EasyFresh-Safe cover
- Drawer

**Clean with a damp cloth:**

- Retractable rails  
Please note: The grease in the tracks is used for lubrication and must not be removed!

**Wash in the dishwasher up to 60 °C:**

- Door rack
- VarioBox
- Bottle rack
- Shelf
- Dividing shelf
- Holder of the dividing shelf
- Egg rack
- Butter dish
- ▶ To disassemble components: see the relevant section.
- ▶ Clean the components.

## 9.4.5 After cleaning

- ▶ Wipe the appliance and the components dry.
- ▶ Connect and switch on the appliance.  
The temperature is cold enough:
- ▶ Place the food inside.
- ▶ Repeat cleaning regularly.

# 10 Customer help

## 10.1 Technical specifications

Temperature range	
Cooling	2 °C to 9 °C

For appliances with a WiFi connection:

Frequency specification	
Frequency band	2.4 GHz
Maximum radiated power	< 100 mW
Purpose of the wireless equipment	Integration in the local WiFi network for data communication

## 10.2 Operating noises

The appliance makes different noises when it is on.

- At **higher temperatures** the appliance uses less energy but works for longer. It is **quieter**.
- At **lower temperatures** the food is cooled faster. It is **louder**.

Examples:

- Functions on (see 7.2 Appliance functions)
- Fan running
- Food recently added
- High ambient temperature
- Door open for a while

Noise	Possible cause	Type of noise
Bubbling and splashing	Coolant flowing into the cooling circuit.	Normal operating noise
Hissing	Coolant sprays into the cooling circuit.	Normal operating noise
Humming	The appliance is cooling. The volume depends on the cooling output.	Normal operating noise
Suction noises	Soft-closing door is being opened and closed.	Normal operating noise
Humming and rustling	The fan is running.	Normal operating noise
Clicking	Components are switched on and off.	Normal switching noise
Rattling or humming	Valves or flaps are working.	Normal switching noise

Noise	Possible cause	Type of noise	Lifting
Vibration	Improper setup	Defective noise	Level the appliance using the adjustable feet.
Rattling	Components, items inside the appliance	Defective noise	Secure components. Leave enough space between the items.

## 10.3 Technical fault

Your appliance is designed and built to ensure it works reliably and has a long service life. In the unlikely event that a fault occurs during operation, please check whether it is due to an operating error. If so, you will be charged for the

callout and repair costs even if it falls within the warranty period.

You can fix the following faults yourself.

### 10.3.1 Appliance function

Defect	Cause	Remedy
<b>The appliance is not working.</b>	→ The appliance is not switched on.	▶ Switch the appliance on.
	→ The power plug is not properly plugged into the socket.	▶ Check the power plug.
	→ There is something wrong with the power outlet fuse.	▶ Check the fuse.
	→ Power cut	▶ Keep the appliance closed. ▶ Protecting food: Lay freezer packs on top of the food or use another freezer if the power is off for a prolonged period. ▶ Do not re-freeze defrosted food,
	→ The appliance plug does not fit the appliance properly.	▶ Check the appliance plug.
<b>Temperature is not cold enough.</b>	→ The appliance door is not closed properly.	▶ Close the appliance door.
	→ Not enough ventilation.	▶ Keep ventilation grille clear, and clean it.
	→ The ambient temperature is too high.	▶ Problem solution: (see 1.4 Appliance range of use)
	→ The appliance was opened too many times or for too long.	▶ Wait to see if the required temperature corrects itself. If not, contact Customer Service. (see 10.4 Customer Service)
	→ The temperature is set incorrectly.	▶ Turn down the temperature and check after 24 hours.
	→ The appliance is too close to a heat source (oven, radiator, etc).	▶ Move the appliance or the heat source.
<b>The door seal is defective or needs to be replaced for another reason.</b>	→ The door seal can be replaced. It can be replaced without the need for special tools.	▶ Contact Customer Service. (see 10.4 Customer Service)
<b>The appliance builds up too much ice or condensation.</b>	→ The door seal may have slipped out of its groove.	▶ Check that the door seal is well fitted in the groove.
<b>The appliance is hot to touch on the outside*.</b>	→ The heat of the refrigeration circuit is used to avoid condensation.	▶ This is normal.

### 10.3.2 Features

Defect	Cause	Remedy
<b>The internal light does not come on.</b>	→ The appliance is not switched on.	▶ Switch the appliance on.
	→ The door was open for longer than 15 minutes.	▶ Interior lighting turns off automatically after approx. 15 min. with the door open.
	→ The LED interior light is faulty or the lid is damaged.	▶ Contact Customer Service. (see 10.4 Customer Service)

# Shutting down

## 10.4 Customer Service

First check whether you can rectify the fault yourself (see 10 Customer help) . If you cannot rectify the problem, contact Customer Service.

You can find the address in the enclosed brochure "Liebherr-Service" or at [home.liebherr.com/service](http://home.liebherr.com/service).



### WARNING

Unprofessional repair!  
Injuries.

- ▶ Have any repairs and action - not expressly specified - on the appliance and mains cable carried out by service personnel only. (see 9 Maintenance)
- ▶ A damaged mains cable may only be replaced by the manufacturer, the manufacturer's Customer Service or a similarly qualified person.
- ▶ In the case of appliances with an IEC connector, the change may be made by the customer.

### 10.4.1 Contacting Customer Service

Make sure that the following appliance information is available:

- Appliance name (model and index)
  - Service no. (Service)
  - Serial no. (S no.)
  - ▶ Call up the appliance information via the display. (see Info)
- or-
- ▶ Refer to the type plate for appliance information. (see 10.5 Model plate)
  - ▶ Note down the appliance information.
  - ▶ Notify customer service: Report errors and the appliance information.
  - ▷ This will help us to provide you with a faster, more accurate service.
  - ▶ Follow further instructions from Customer Service.

## 10.5 Model plate

The model plate is behind the drawers on the inside of the appliance.

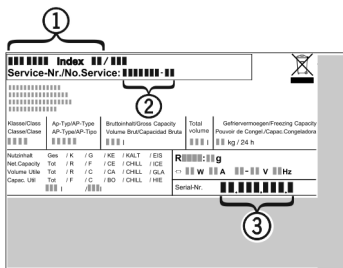

Fig. 85

- (1) Appliance description      (3) Serial no.
- (2) Service no.
- ▶ Note the data on the model plate.

## 11 Shutting down

- ▶ Empty the appliance.
- ▶ Switch off appliance. (see Turn off appliance)
- ▶ Remove mains connector.
- ▶ Remove appliance connector if required: Remove and move from left to right at the same time.
- ▶ Clean appliance. (see 9.4 Cleaning the appliance)
- ▶ Leave the door open, so that no unpleasant odours arise.

## 12 Disposal

### 12.1 Preparing appliance for disposal



Li-Ion

Liebherr uses batteries in some of its appliances. In the EU, for environmental reasons, legislation obliges the end user to remove these batteries before disposing of old appliances. If your appliance contains batteries, a corresponding notice is attached.

Lamps

If you can remove the lamps yourself without destroying them, also remove these before disposal.

- ▶ Take the appliance out of operation.
- ▶ Appliances with batteries: remove the batteries. For description, see **Maintenance** chapter.
- ▶ If possible: remove lamps without destroying them.

### 12.2 Disposing of the appliance in an environmentally friendly manner



The appliance still contains valuable materials and must be disposed of separately from unsorted municipal waste.



Li-Ion



Li-Ion

Dispose of batteries separately from the old appliance. To do this, you can return the batteries free of charge to retailers as well as recycling centres and collection centres for recyclable materials.

Lamps

Dispose of removed lamps via the respective collection systems.

For Germany:

You can dispose of the appliance free of charge via the class 1 collection containers at the local recycling and recyclable material collection centres. When purchasing a new fridge/freezer, if the sales area > 400 m<sup>2</sup>, retailers will also take back the old appliance free of charge.



### WARNING

Leaking coolant and oil!  
Fire. The coolant contained in the appliance is eco-friendly, but also flammable. The oil contained in the appliance is flammable. Escaping coolant and oil can ignite if the concentration is high enough and in contact with an external heat source.

- ▶ Do not damage the pipelines of the coolant circuit and the compressor.

- ▶ Transport the appliance without damaging it.
- ▶ Dispose of batteries, lamps and the appliance according to the above specifications.







[home.liebherr.com/fridge-manuals](https://home.liebherr.com/fridge-manuals)

**EN**

Issue date: 20240130

**Part number index: 7083570-00**

Liebherr-Hausgeräte Marica E00D  
Bezirk Plovdiv  
4202 Radinovo  
Bulgarien