



Installation Guide

Quality, Design and Innovation



home.liebherr.com/fridge-manuals







LIEBHERR



General safety instructions

Contents

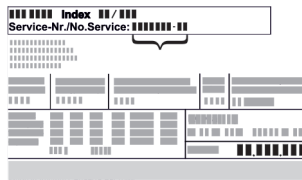
1	General safety instructions.....	2
2	Setup conditions.....	3
2.1	Space.....	3
2.2	Fitting the appliance into the kitchen unit.....	3
2.3	Setting up multiple appliances.....	4
2.4	Electrical connection.....	5
3	Installation dimensions.....	5
4	Ventilation requirements.....	6
5	Transporting the appliance.....	6
6	Unpacking the appliance.....	6
7	Mounting wall spacers.....	6
8	Setting up the device.....	6
9	Setting up the appliance level.....	6
10	After setup.....	7
11	Disposal of packaging.....	7
12	Explanatory symbols used.....	7
13	Reversing the door.....	8
13.1	Removing the door.....	8
13.2	Moving the upper bearing parts to the other side..	9
13.3	Moving the lower bearing parts to the other side..	10
13.4	Moving the door bearing parts to the other side....	10
13.5	Moving the handles to the other side*.....	11
13.6	Fitting the door.....	12
13.7	Aligning the door.....	12
13.8	Fitting the covers.....	12
14	Connecting the appliance.....	13

The manufacturer is constantly working to improve all types and models. Therefore, please be aware that we reserve the right to make changes to the shape, equipment and technology.

Symbol	Explanation
	<p>Read instructions</p> <p>Please read the information in these instructions carefully to understand all of the benefits of your new appliance.</p>
	<p>Additional information online</p> <p>The digital manual with supplemental information and in additional languages can be found online by scanning the QR code on the front page of this manual or by entering the service number at home.liebherr.com/fridge-manuals.</p> <p>The service number can be found on the serial tag:</p>  <p style="text-align: center;"><i>Fig. Example illustration</i></p>
	<p>Check appliance</p> <p>Check all parts for transport damage. If you have any complaints, please contact your agent or customer service.</p>

Symbol	Explanation
	<p>Differences</p> <p>These instructions apply to a range of models, so there may be differences. Sections that apply to certain models only are indicated by an asterisk (*).</p>
	<p>Instructions and results</p> <p>Instructions are marked with a ▶.</p> <p>Results are marked with a ▷.</p>
	<p>Videos</p> <p>Videos about the appliances are available on the YouTube channel of Liebherr-Hausgeräte.</p>



1 General safety instructions

- Please keep this assembly manual in a safe place so you can refer back to it at any time.
- If you pass the appliance on, please hand this assembly manual to the new owner.
- Read this assembly manual before installation and use in order to use the appliance safely and correctly. Follow the instructions, safety instructions and warning messages included at all times. They are important for ensuring you can operate and install the appliance safely and without any problems.
- First read the general safety instructions in the “General safety instructions” section of the **operating instructions**, which accompany these installation instructions, and follow them. If you cannot find the **operating instructions**, you can download the **operating instructions** from the internet by entering the service number at home.liebherr.com/fridge-manuals. The service number can be found on the serial



tag:

- **Observe the warning messages and other detailed information in the other sections when installing the appliance:**

	DANGER	indicates a hazardous situation, which if not avoided, will result in death or serious injury.
	WARNING	indicates a hazardous situation, which if not avoided, could result in death or serious injury.

	CAUTION	indicates a hazardous situation, which if not avoided, will result in minor or moderate injury.
	NOTICE	indicates a hazardous situation, which if not avoided, could result in damage to property.
	Note	indicates useful advice and tips.

2 Setup conditions



WARNING

Risk of fire due to moisture!

If live parts or the power cord get wet, this can cause a short circuit.

- ▶ The appliance is designed for use in enclosed spaces. Do not operate the appliance in open space or in damp areas or where there is spray.

Normal use

- Only set up and use the appliance in enclosed spaces.

2.1 Space



WARNING

Leaking refrigerant and oil!

Fire. The refrigerant contained within the appliance is environmentally friendly, but flammable. The oil contained within the appliance is flammable. Escaping refrigerant and oil can ignite if they are of high enough concentration and are exposed to an external heat source.

- ▶ Do not damage the pipelines of the coolant circuit and the compressor.

- The optimal installation site is a dry and well ventilated room.
- If the appliance is installed in a very damp environment condensate water may form on the outside of the appliance. Always ensure sufficient airflow and ventilation in the setup location.
- The more refrigerant there is in the appliance, the larger the space that it is installed in must be. If the space is too small, any leak may create a flammable mixture of gas and air. For every 8 g of refrigerant, the installation space must be at least 1 m³. Specifications on the refrigerant in the appliance can be found on the serial tag plate inside the appliance.

2.1.1 Installation surface

- The floor of the installation site must be horizontal and level.
- The height of the appliance base must be the same as the surrounding floor.

2.1.2 Installation position

- Do not set up the appliance in an area with direct sunlight, next to a heating unit or similar.
- You can set up the appliance directly next to an oven.
- If you set up the appliance directly next to an oven, its energy consumption may increase slightly. This depends on the service life and how often the oven is used.
- Always stand the appliance backed directly to the wall using the enclosed wall spacers (see below).

2.2 Fitting the appliance into the kitchen unit

You can install kitchen cabinets around the appliance.

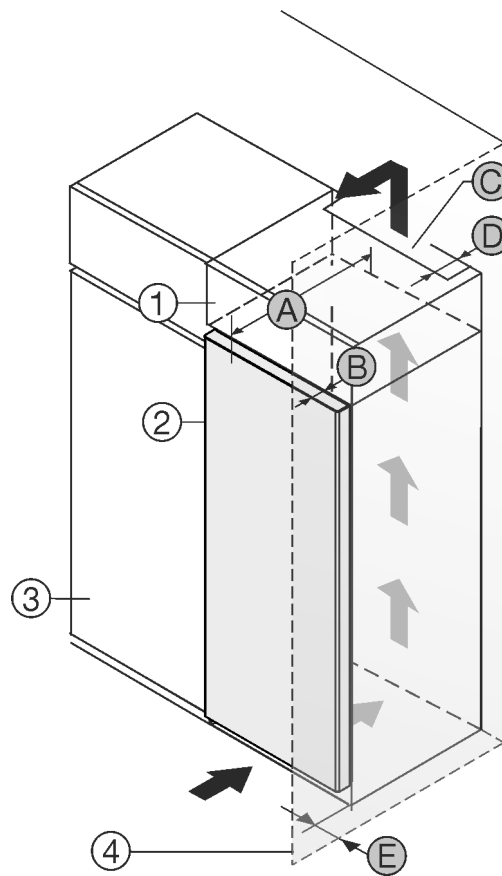

Fig. 1

- (1) Top cupboard *
- (2) Appliance *
- (3) Kitchen cabinet *
- (4) Wall *
- (A) Appliance depth *
- (B) Door depth *
- (C) Ventilation cross-section *
- (D) Distance to the rear of the appliance *
- (E) Distance to the side of the appliance *

You can place the appliance directly beside the kitchen cabinet Fig. 1 (3).

There must be a ventilation shaft at the depth Fig. 1 (D) of the back of the top cupboard over the entire width of the top cupboard.*

The cross section of the ventilation gap Fig. 1 (C) must be maintained below the ceiling.*

If the appliance is set up with the hinges next to a wall Fig. 1 (4), the distance between the appliance and the wall must be at least 13 mm.*

In order to be able to fully open the door, the appliance must protrude by the depth of the door Fig. 1 (B) from the front of the kitchen cabinet. Regardless of the depth of the kitchen cabinets Fig. 1 (3) and use of wall spaces, the appliance can protrude further.*

Appliances without handle / with recessed grip:*	
A	675 mm *
B	75 mm
C	Min. 300 cm ²
D	mind. 50 mm

Setup conditions

Appliances without handle / with recessed grip:*	
E	Min. 13 mm

* The use of wall spacers increases the dimensions by 15 mm (see 7 Mounting wall spacers) .*

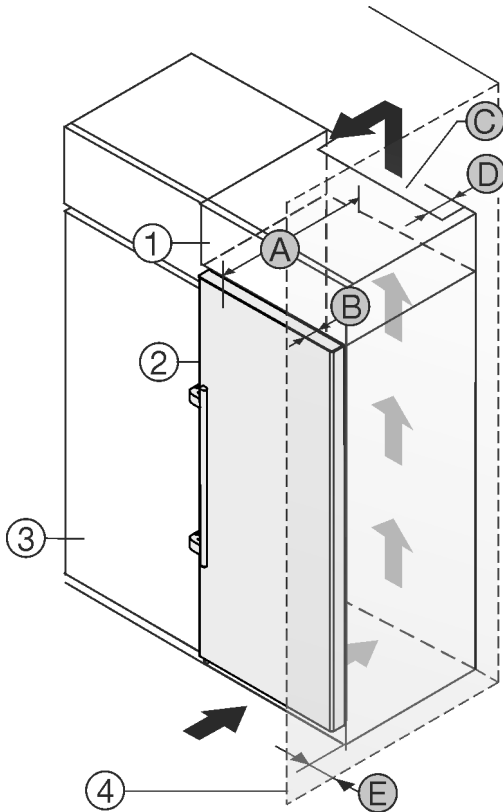

Fig. 2

- (1) Top cabinet *
- (2) Appliance *
- (3) Kitchen cabinet *
- (4) Wall *
- (A) Appliance depth *
- (B) Door depth *
- (C) Ventilation cross-section *
- (D) Distance to the rear of the appliance *
- (E) Distance to the side of the appliance *

You can place the appliance directly beside the kitchen cabinet Fig. 2 (3).*

There must be a ventilation shaft at the depth Fig. 2 (D) of the back of the top cupboard over the entire width of the top cupboard.*

The cross section of the ventilation gap Fig. 2 (C) must be maintained below the ceiling.*

If the appliance is set up with the hinges next to a wall Fig. 2 (4), the distance between the appliance and the wall must be at least 57 mm . This is how far the handle protrudes when the door is open.*

In order to be able to fully open the door, the appliance must protrude by the depth of the door Fig. 2 (B) from the front of the kitchen cabinet. Regardless of the depth of the kitchen cabinets Fig. 2 (3) and use of wall spaces, the appliance can protrude further.*

Appliances with lever handle:*	
A	675 mm *
B	75 mm
C	Min. 300 cm ²
D	mind. 50 mm

Appliances with lever handle:*	
E	Min. 57 mm

* The use of wall spacers increases the dimensions by 15 mm (see 7 Mounting wall spacers) .*

Ensure that the following conditions are met:

- Recess dimensions are adhered to .
- Ventilation requirements are complied with (see 4 Ventilation requirements) .

2.3 Setting up multiple appliances

The appliances were developed for different installation options. If you want to install several appliances side by side or on top of each other, make sure that the following requirements are met:

- Only install those appliances side by side or on top of each other that were developed for the purpose.
- Observe the instructions and the following table.

NOTICE

Risk of damage caused by water condensate!

- ▶ Do no set up the appliance next to another refrigeration/ freezer unit.

Model	Installation type
All models	individually
Models with a model designation that starts with S...	Side-by-side (SBS)

3 Installation dimensions



Fig. 3

Dimensions without lever handle (mm):					
	h	a	b	c	d
RB/a 42../i	1255	597	675 ^x	609	1215 ^x
FN/c/d/e 42.. GN 42Ve04 / GN 42Vd24	1255	597	675 ^x	609	1215 ^x
FN/c/d/e 46../i GN 46Ve05 / GN 46Vd25 GNeu 1460DI	1455	597	675 ^x	609	1215 ^x
FN/c/d/e 50../i GN 50Ve06 / GN 50Vd26	1655	597	675 ^x	609	1215 ^x
S/FN/d/c/sdd/std/bdd/sde /sfd 52../i GN 52Ve07 / GN 52Vd2i SGN 52Vd27	1855	597	675 ^x	609	1215 ^x
FN/a/c/d/e 66 ../i	1455	698	760 ^x	710	1402 ^x
FN/c/d/e 70 ../i	1655	698	760 ^x	710	1402 ^x
FN/c/d/e 72 ../i	1855	698	760 ^x	710	1402 ^x

Dimensions with lever handle (mm):					
	h	a	b'	c'	d'
RB/a 42../i	1255	597	719 ^x	654	1222 ^x
FN/b/c/d/e 42...(i)	1255	597	719 ^x	654	1222 ^x
FN/c/d/e 46../i GNex 1460 ci	1455	597	719 ^x	654	1222 ^x
FN/c/d/e 50../i LTGN-234	1655	597	719 ^x	654	1222 ^x
S/FN/d/c/sdd/std/bsd/sde 52../i LTGN-270	1855	597	719 ^x	654	1222 ^x
FN/c/d/e 66 ../i	1455	698	804 ^x	754	1408 ^x

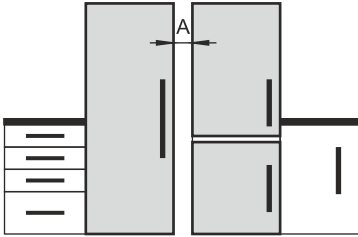
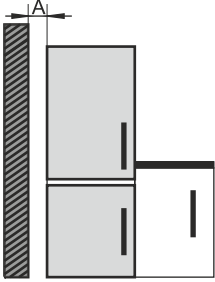
Model	Installation type
Models without side wall heating	 <p>Next to each other: Install with a distance A from 70 mm between the appliances.</p> <p>Next to each other: Install with a distance A from 100 mm between the appliances.</p> <p>If you do not keep this distance, condensate can form on the side walls between the appliances.</p>  <p>At an outside wall: Install with a distance A as for a side-by-side installation.</p> <p>If you do not keep this distance, condensate can form on the side wall of the appliance.</p>

Models and their installation type

Assemble the appliances according to the separate assembly instructions.

2.4 Electrical connection



WARNING

Danger of fire due to incorrect positioning!
If the power supply cable or plug touches the back of the appliance, the vibration can damage the power supply cable or the plug resulting in a short circuit.

- ▶ Make sure the power supply cable is not trapped under the appliance when you position the appliance.
- ▶ Install the appliance so that it does not touch any plugs or power cables.
- ▶ Do not connect any appliances to sockets in the area of the back of the appliance.
- ▶ Do **not** place and operate power strips/power distributors and other electronic devices (such as halogen transformers) at the back of the appliances.

Ventilation requirements

Dimensions with lever handle (mm):					
FN/c/d/e 70 ../i	1655	698	804 ^x	754	1408 ^x
FN/c/d/e 72 ../i	1855	698	804 ^x	754	1408 ^x

^x For appliances with supplied wall spacers, the dimension must be increased by 15 mm (see 7 Mounting wall spacers).

4 Ventilation requirements

NOTICE

Risk of damage due to overheating in the case of insufficient ventilation!

In the case of insufficient ventilation, the compressor can be damaged.

- ▶ Make sure there is sufficient ventilation.
- ▶ Observe the ventilation requirements.

If the appliance is integrated in a fitted kitchen, the following ventilation requirements must be met:

- The spacing fins on the back of the appliance are used to ensure sufficient ventilation. These must not lie in cavities or recesses in their final installation position.
- Basically, the larger the ventilation gap, the more energy the appliance saves during operation.

5 Transporting the appliance

Observe the following when transporting the appliance:

- ▶ Transport the appliance upright.
- ▶ Use two people when transporting the appliance.

During the first use:

- ▶ Transport the appliance packaged.

During appliance transport or at first use (e.g. when moving or cleaning):

- ▶ Empty the appliance.
- ▶ Secure the door against undesired opening.

6 Unpacking the appliance

If the appliance is damaged check with the supplier immediately before connecting it.

- ▶ Check the appliance and packaging for damage during transport. If you suspect any damage, please contact your supplier immediately.
- ▶ Remove all materials that could prevent it from being installed properly or prevent proper ventilation from the back or the side panels of the appliance.
- ▶ Remove all protective films from the appliance. Do not use sharp or pointed objects for this.
- ▶ Remove the mains cable from the back of the appliance. Also remove the cable holder, otherwise there will be vibration noise!

7 Mounting wall spacers

With the wall spacer, your appliance will achieve the specified energy consumption and no condensation will form in high ambient humidity. The appliance will work properly without using the wall spacer, but with a slightly higher energy consumption.

If you use the wall spacer, the appliance depth increases by approx. 15 mm.

- ▶ Appliance with supplied wall spacers: Fit wall spacers on the rear of the appliance at the bottom left and right.

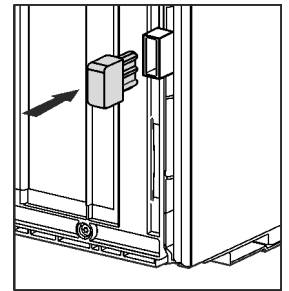

8 Setting up the device



CAUTION

Risk of injury due to heavy appliance!

- ▶ Have two people transport the appliance to its installation site.



WARNING

Risk of fire from short circuit!

- ▶ When setting up the appliance: Do not kink, trap, or damage the power cable.
- ▶ Do not operate the appliance with a defective power cable.



WARNING

Danger of injury and damage due to the appliance being unstable!

The appliance can tip over.

- ▶ Secure the appliance as described in the instructions.



WARNING

Danger of fire and damage!

- ▶ Do not place devices that give off heat, e.g. microwaves, toasters, etc. on the appliance.

Make sure that the following requirements are fulfilled:

- Only move the appliance when it is not loaded.
- Always install the appliance with help.
- ▶ Remove the power cable from the enclosed package.
- ▶ Fully insert the IEC socket of the power cable completely into the appliance plug on the rear side of the appliance. Ensure the IEC socket is firmly in place.
- ▶ If necessary, use a string to route the power plug to a socket outlet that is freely accessible.

9 Setting up the appliance level



CAUTION

Risk of injury or damage from the appliance tipping or the door falling open!

If the additional adjustable foot on the base support is not correctly positioned on the floor, there is a risk of the door falling open or the appliance tipping. This can lead to injury or property damage.

- ▶ Unscrew the additional adjustable foot on the support until it reaches the floor.
- ▶ Then turn it another 90°.

- ▶ Align the appliance so that it stands firmly and by applying the accompanying spanner to the adjustable height feet (A) and using a spirit level.
- ▶ Then prop up the door: Lower the adjustable foot on the bearing bracket (B) until it contacts the floor, then turn it an additional 90°.

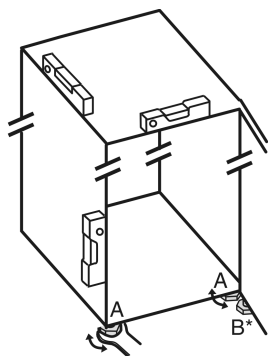

- ▶ Then prop up the door: Screw out the adjustable foot on the bearing bracket (B) using the open-ended wrench SW10 until it comes into contact with the floor, then turn an additional 90°.

10 After setup

- ▶ Pull off the protective film from the outside of the housing.*
- ▶ Pull off the protective film from the trim strips.
- ▶ Pull off the protective film from the trim strips and drawer fronts.
- ▶ Take off the protective film from the stainless steel rear panel.
- ▶ Remove all transport packaging.
- ▶ Clean the appliance. (see operating instructions)
- ▶ Note the type (model, number), appliance designation, appliance/serial number, purchase date and dealer's address.

11 Disposal of packaging



WARNING

Danger of suffocation from packaging materials and films!

- ▶ Do not allow children to play with packaging materials.

The packaging is made from recyclable materials:









- Corrugated card/cardboard
- Parts made of foamed polystyrene
- Films and bags from polyethylene
- Packing bands from polypropylene
- Wood frame nailed together with a polyethylene window*
- ▶ Take the packaging material to an official collection point.

12 Explanatory symbols used

	There is the risk of injury when doing this! Obey the safety instructions!
	These instructions apply to several models. Only perform this step if it applies to your appliance.
	To install, please follow the detailed description in the Guide.

	This section applies either to a single-door appliance or a double-door appliance.
	Choose one of the options: Appliance with right-hinged door or appliance with left-hinged door.
	Installation step necessary with IceMaker and/or InfinitySpring.
	Loosen or tighten screws slightly.
	Tighten the screws fully.
	Check to see if the next step applies for your model.
	Check the components are in correctly.
	Measure the specified measurement and adjust if necessary.
	Installation tool: Meter stick
	Tool for assembly: Cordless screwdriver and attachments We recommend a longer bit insert to reach the screws better.
	Tool for assembly: Spirit level
	Tool for assembly: Size 7 and size 10 spanner
	Two people are required for this step.

Reversing the door

	This step takes place at the selected location of the appliance.
	Aid for assembly: String
	Aid for assembly: Square
	Aid for assembly: Screwdriver
	Aid for assembly: Scissors
	Aid for assembly: Non-permanent marker pen
	Accessory kit: Remove components
	Dispose of components that are no longer needed.

13 Reversing the door

Tools

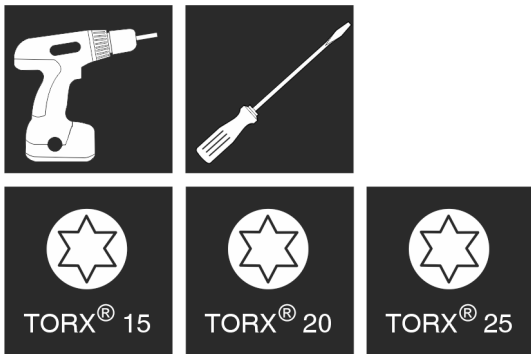

Fig. 4



WARNING

Danger of injury due to door falling out!
If the bearing parts are not screwed on tightly enough, the door may fall out. This can result in serious injuries. In addition, the door may not close causing the appliance to cool improperly.

- ▶ Screw on the bearing brackets/bearing pins tightly with 4 Nm.
- ▶ Check all screws and retighten them if necessary.

These sections apply for appliances **without a soft stop mechanism**:

- For appliances **without** the a stop mechanism
- For all appliances

NOTICE

Risk of damage to side-by-side appliances caused by condensate!

Certain appliances can be set up as side-by-side combinations (two appliances beside one another).

If your appliance **is a side-by-side appliance**:

- ▶ Install the SBS combination in accordance with the accompanying sheet.

If the **configuration of appliances is specified**:

- ▶ Do not change the door stop.

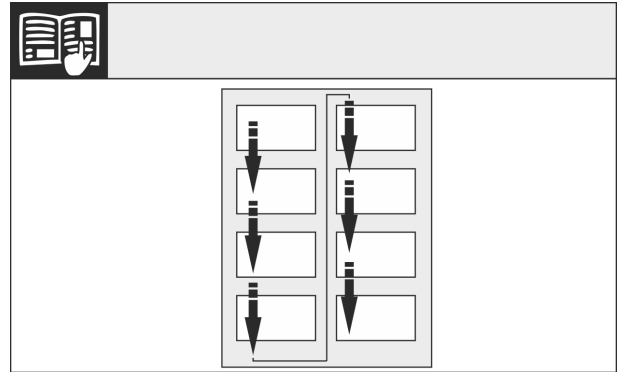

Fig. 5

Observe the reading direction.

13.1 Removing the door

Note

- ▶ To prevent food items from falling out, take all food out of the door racks before removing the door.

For appliances without soft stop mechanism:

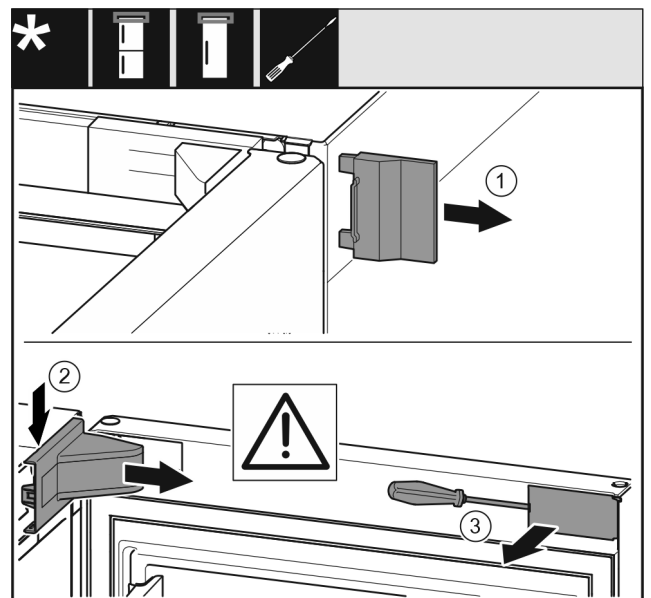

Fig. 6

- ▶ Open the door.

NOTICE

Risk of damage!

If the door seal is damaged the door may not close properly and the level of cooling is insufficient.

- ▶ Do not damage the door seal with the screwdriver!

- ▶ Remove the outer cover. *Fig. 6 (1)*
- ▶ Disengage and release the bearing bracket cover. Remove the bearing bracket cover. *Fig. 6 (2)*
- ▶ Unlatch the panel with a slotted screwdriver and swivel it to one side. *Fig. 6 (3)*

For all appliances:

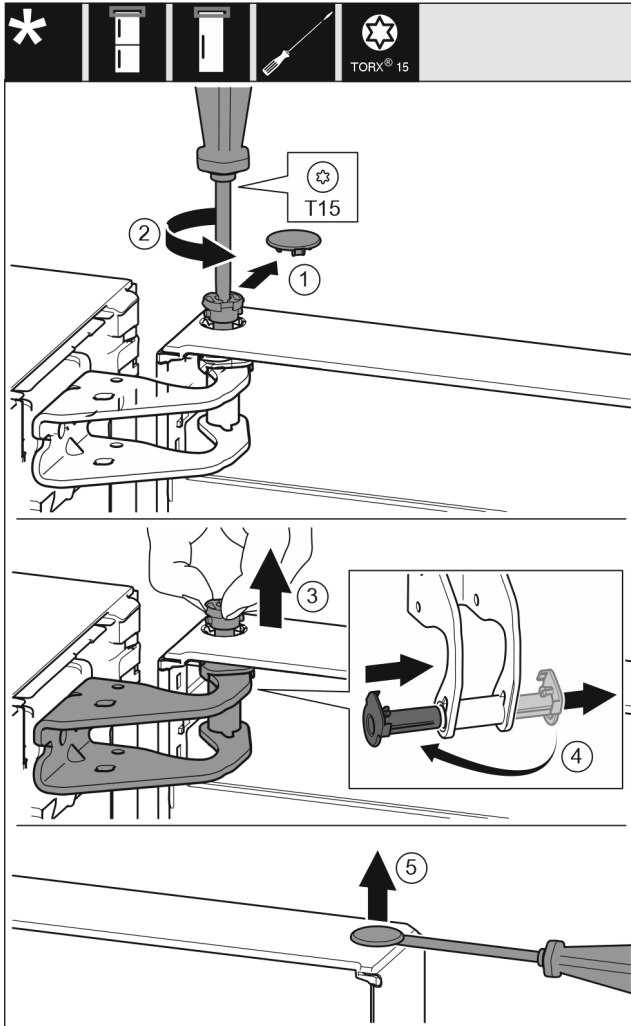

Fig. 7

CAUTION

- Risk of injury if the door tips out!
- ▶ Keep a steady grip on the door.
 - ▶ Set the door down carefully.

- ▶ Carefully remove the protective cover. *Fig. 7 (1)*
- ▶ Loosen the bolts slightly with a T15 screwdriver. *Fig. 7 (2)*
- ▶ Hold the door and remove the bolts with your fingers. *Fig. 7 (3)*
- ▶ Pull the bearing bush out of the guide. Insert from the other side and latch into place. *Fig. 7 (4)*
- ▶ Lift the door and place it to one side.
- ▶ Carefully lift the plugs out of the door bearing bush with a slotted screwdriver and remove them. *Fig. 7 (5)*

13.2 Moving the upper bearing parts to the other side

For all appliances:

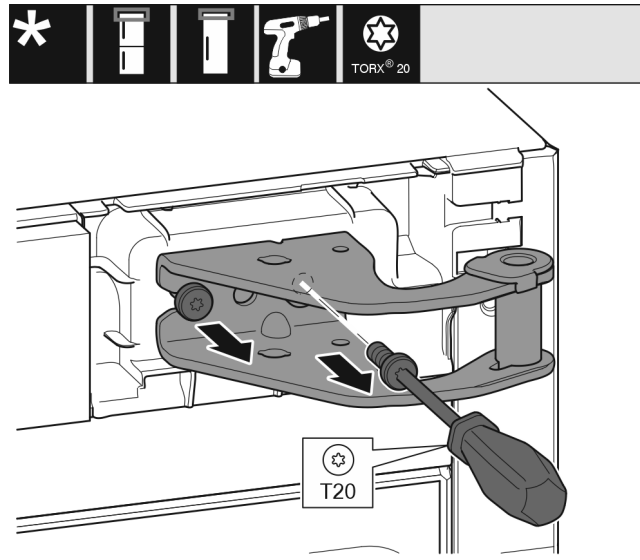

Fig. 8

- ▶ Remove both screws with a T20 screwdriver.
- ▶ Lift and remove the bearing bracket.

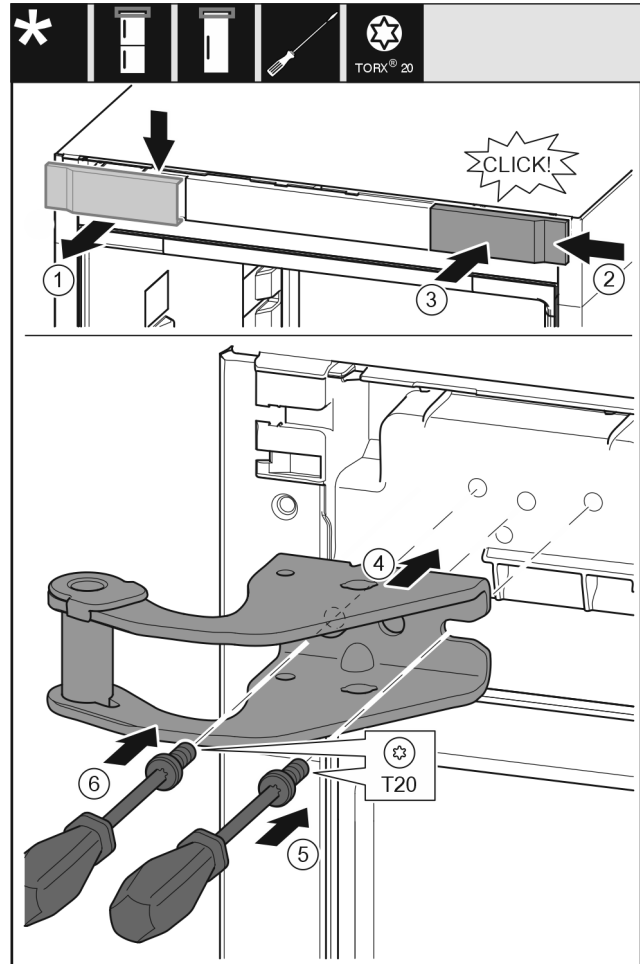

Fig. 9

- ▶ Take off the cover to the front from above. *Fig. 9 (1)*
- ▶ Rotate the cover 180° and clip onto the other side from the right. *Fig. 9 (2)*
- ▶ Latch the cover into place. *Fig. 9 (3)*
- ▶ Position the upper bearing bracket. *Fig. 9 (4)*
- ▶ Insert the screw with a T20 screwdriver and tighten it. *Fig. 9 (5)*
- ▶ Insert the screw with a T20 screwdriver and tighten it. *Fig. 9 (6)*

Reversing the door

13.3 Moving the lower bearing parts to the other side

For all appliances:

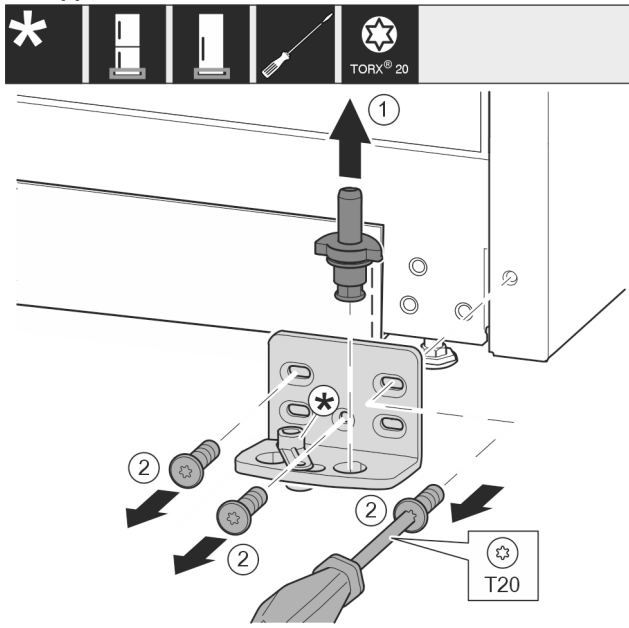

Fig. 10

- ▶ Lift the bearing pin completely upward and remove it. Fig. 10 (1)
- ▶ Remove the screws with the T20 screwdriver and take off the bearing bracket. Fig. 10 (2)

For appliances without soft stop mechanism:

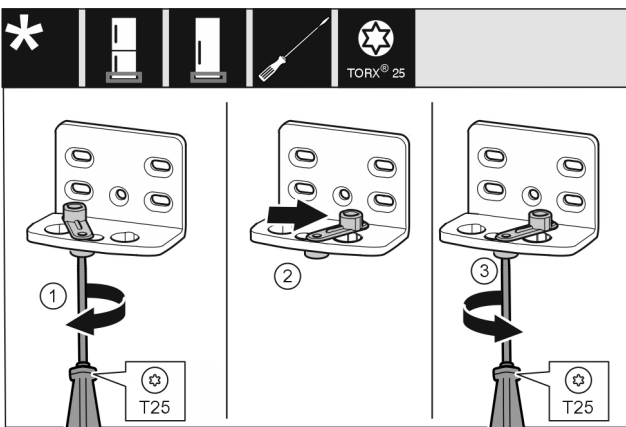

Fig. 11

- ▶ Loosen the screw using a T25 screwdriver. Fig. 11 (1)
- ▶ Lift the door closing aid and turn it 90° to the right in the hole. Fig. 11 (2)
- ▶ Tighten the screw using the T25 screwdriver. Fig. 11 (3)

For all appliances:

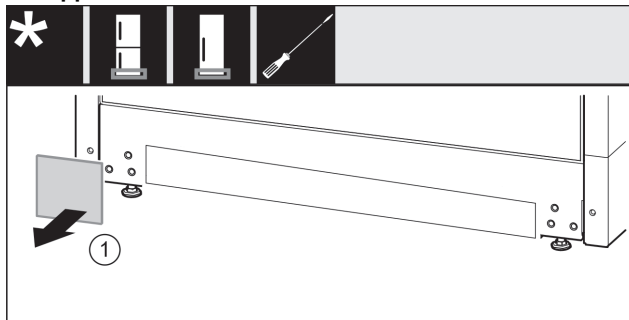

Fig. 12

- ▶ Take off the cover. Fig. 12 (1)



Fig. 13

- ▶ Unscrew the metal plate, move it to the other side and screw it on again. Fig. 13 (1)

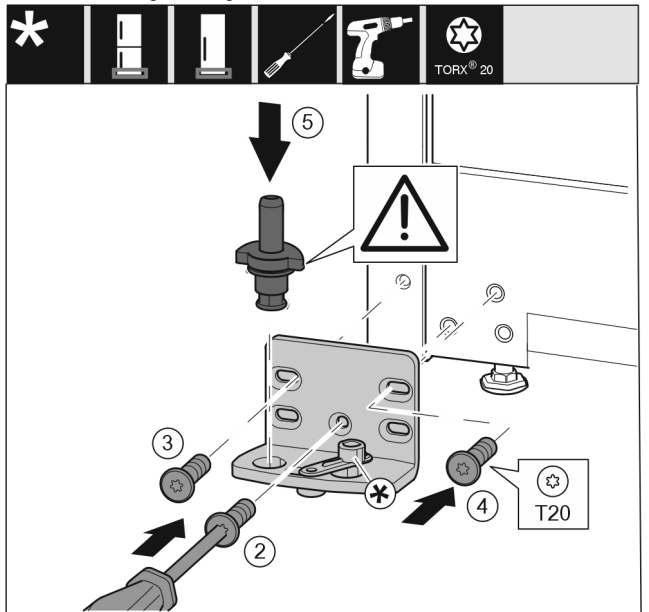

Fig. 14

- ▶ Place the bearing bracket on the other side and screw it in using the T20 screwdriver. Start with screw 2 at the bottom in the middle. Fig. 14 (2)
- ▶ Screw in screws 3 and 4. Fig. 14 (3,4)
- ▶ Insert the bearing pin completely. Make sure that the latching lug is pointing to the rear. Fig. 14 (5)

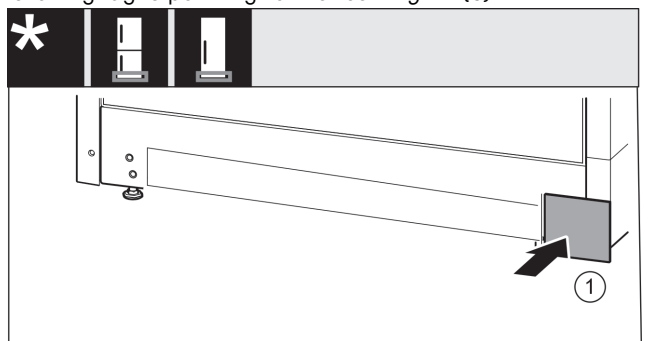

Fig. 15

- ▶ Put back the cover on the other side. Fig. 15 (1)

13.4 Moving the door bearing parts to the other side

For appliances without soft stop mechanism:



Fig. 16

- ▶ Underside of door faces upwards: Turn the door.
- ▶ Push the lug downward with a slotted screwdriver. Fig. 16 (1)
- ▶ Pull the door latch out of the guide. Fig. 16 (2)
- ▶ Push the door latch into the guide on the other side. Fig. 16 (3)
- ▶ Upper side of door faces upwards: Turn the door.

13.5 Moving the handles to the other side*

For all appliances:



Fig. 17

- ▶ Pull off the cover. Fig. 17 (1)
- ▶ Remove the screws with the T15 screwdriver. Fig. 17 (2)
- ▶ Remove the handle. Fig. 17 (3)
- ▶ Carefully lift up the side plugs with a slotted screwdriver and pull them out. Fig. 17 (4)
- ▶ Insert the plugs again on the other side. Fig. 17 (5)

Reversing the door



Fig. 18

- ▶ Position the handle on the opposite side. Fig. 18 (1)
- ▷ The screw holes must be exactly above each other.
- ▶ Tighten the screws using the T15 screwdriver. Fig. 18 (2)
- ▶ Position the covers on the side and push them on. Fig. 18 (3)
- ▷ Ensure that they latch into place correctly.

13.6 Fitting the door

For all appliances:

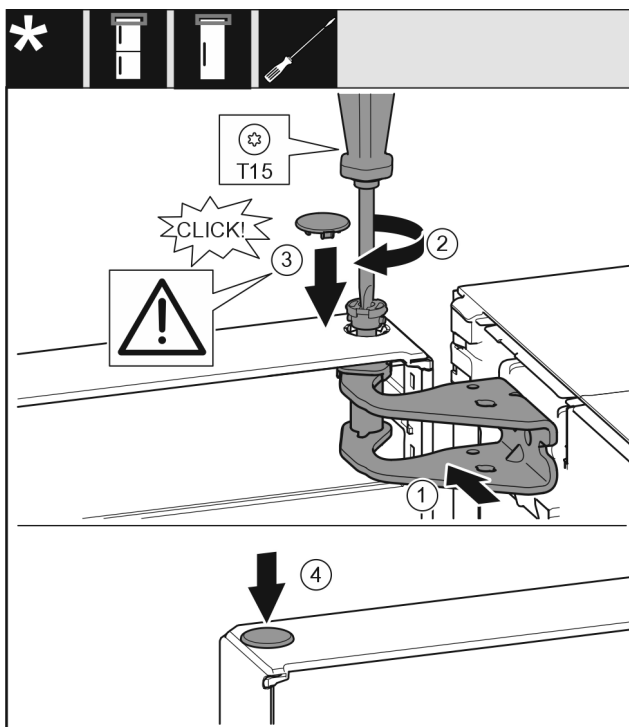

Fig. 19

- ▶ Place the door on the bottom bearing pins.
- ▶ Align the top of the door with opening in the bearing bracket. Fig. 19 (1)
- ▶ Insert the bolt and tighten with a T15 screwdriver. Fig. 19 (2)

- ▶ Fit the protective cover to protect the door: Insert the protective cover and check that it lies flush on the door. If not, insert the bolt fully. Fig. 19 (3)
- ▶ Insert the plugs. Fig. 19 (4)

13.7 Aligning the door

For all appliances:



WARNING

Danger of injury due to door falling out!

If the bearing parts are not screwed on tightly enough, the door may fall out. This can result in serious injuries. In addition, the door may not close causing the appliance to cool improperly.

- ▶ Screw the bearing brackets on firmly with 4 Nm.
- ▶ Check all screws and retighten them if necessary.
- ▶ Align the doors flush with the appliance housing using the two slots in the lower bearing bracket, if needed. To do this undo the middle screw in the bottom bearing bracket with the T20 tool supplied. Undo the remaining screws a little with the T20 tool or with a T20 screwdriver and align via the slots.
- ▶ Prop up the door: Screw out the adjustable foot on the bearing bracket using the open-ended wrench SW10 until it comes into contact with the floor, then turn an additional 90°.

13.8 Fitting the covers

For appliances without soft stop mechanism:

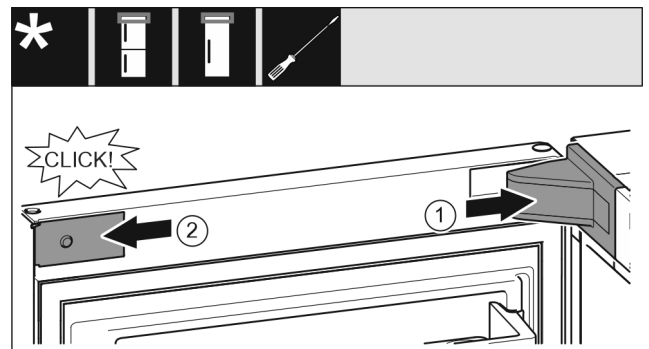

Fig. 20

The door is open 90°.

- ▶ Position the bearing bracket cover and engage it. If necessary push it apart carefully. Fig. 20 (1)
- ▶ Position the panel on the side and latch into place. Fig. 20 (2)

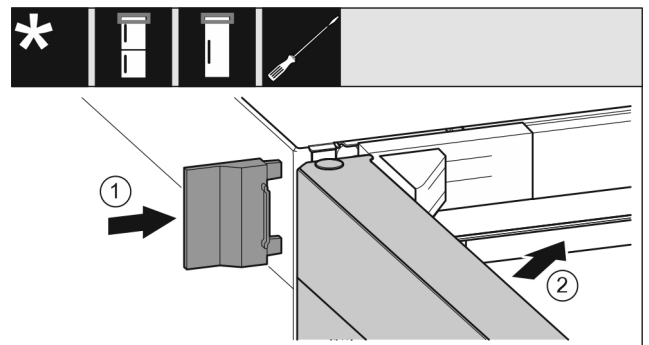

Fig. 21

- ▶ Slide on the outer cover. Fig. 21 (1)
- ▶ Close the upper door. Fig. 21 (2)

14 Connecting the appliance



WARNING

Danger of fire due to incorrect connection!
Burns.

Damage to the appliance.

- ▶ Do not use an extension cord.
 - ▶ Do not use a multipoint connector strip.
-

NOTICE

Danger of damage to incorrect connection!
Damage to the appliance.

- ▶ Do not connect the appliance to a stand-alone inverter, e.g. solar power systems and petrol generators.
-

Note

Only use the mains cable supplied.

- ▶ A longer mains cable can be ordered from Customer Service.
-

Make sure that the following requirements are fulfilled:

- The type of current and voltage at the installation site complies with the information on the serial tag .
- The socket is grounded and fused in accordance with regulations.
- The tripping current for the fuse is between 10 and 16 A.
- The socket is easily accessible.
- The socket is not located behind the appliance but in areas a or b (*a, b, c*).
- ▶ Check the electrical connection.
- ▶ Insert the appliance plug (*G*) on the rear side of the appliance. Ensure that they latch into place correctly.
- ▶ Connect the mains plug to the power supply.
- ▷ The Liebherr logo appears on the screen.
- ▷ The display switches to the standby symbol.



home.liebherr.com/fridge-manuals

EN Freezer

Issue date: 20240710

Part number index: 7088530-00

Liebherr-Hausgeräte Ochsenhausen GmbH
Memminger Straße 77-79
88416 Ochsenhausen
Deutschland