

User Guide

Integrated freezer

EN

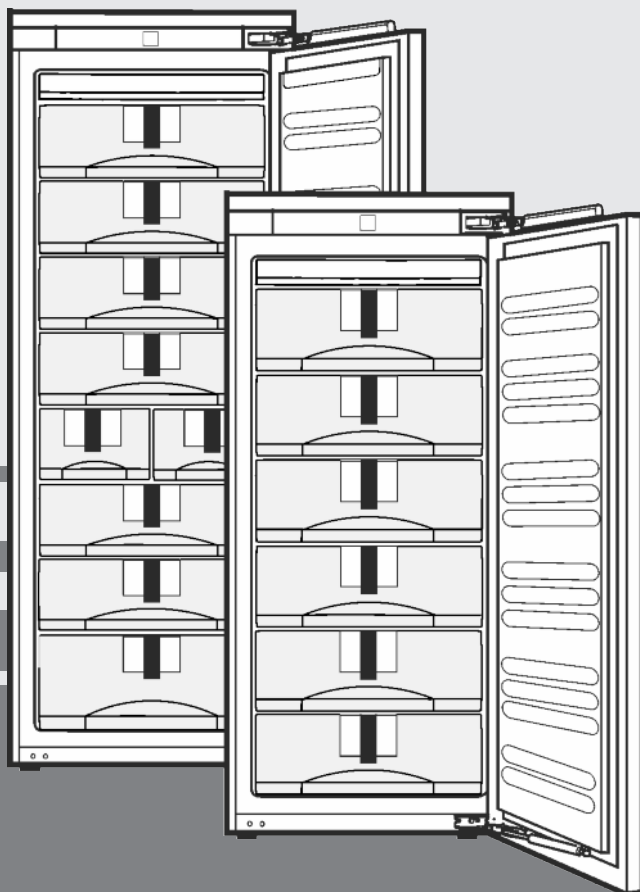

20200831 **7086548 - 00**

SIGN27 / SIGN35

LIEBHERR

Contents

1	Appliance at a glance	2
1.1	Description of appliance and equipment.....	2
1.2	Appliance range of use.....	2
1.3	Conformity.....	3
1.4	Product data.....	3
1.5	EPREL database.....	3
1.6	Saving energy.....	3
2	General safety information	3
3	Controls and displays	4
3.1	Operating and control elements.....	4
3.2	Temperature display.....	4
4	Putting into operation	5
4.1	Switching on the appliance.....	5
5	Control	5
5.1	Child proofing.....	5
5.2	Door alarm.....	5
5.3	Temperature alarm.....	5
5.4	Freezing food.....	5
5.5	Thawing food.....	5
5.6	Setting the temperature.....	5
5.7	SuperFrost.....	6
5.8	Drawers.....	6
5.9	Shelves.....	6
5.10	VarioSpace.....	6
5.11	Extractor rails.....	6
5.12	Information system.....	7
5.13	Ice cube tray*.....	7
5.14	Freezer pack.....	7
5.15	IceMaker*.....	7
6	Maintenance	8
6.1	Defrosting with NoFrost.....	8
6.2	Cleaning the appliance.....	8
6.3	Cleaning the IceMaker*.....	8
6.4	Customer service.....	8
7	Malfunctions	9
8	Decommissioning	10
8.1	Shut off the water intake*.....	10
8.2	Switching off the appliance.....	10
8.3	Taking the appliance out of service.....	10
9	Disposing of the appliance	10

The manufacturer works constantly on the further development of all the types and models. Therefore please understand that we have to reserve the right to make design, equipment and technical modifications.

To get to know all the benefits of your new appliance, please read the information contained in these instructions carefully.

The instructions apply to several models. Differences may occur. Text relating only to specific appliances is marked with an asterisk (*).

Instructions for action are marked with a ►, the results of action are marked with a ▷.

1 Appliance at a glance

1.1 Description of appliance and equipment

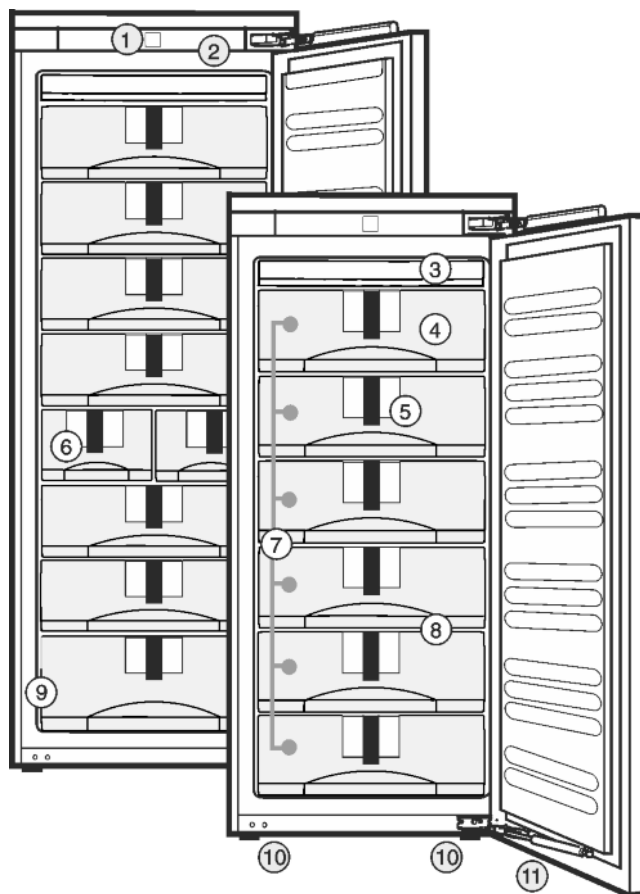

Fig. 1

- | | |
|------------------------------------|-----------------------------|
| (1) Operating and control elements | (7) Drawers |
| (2) LED interior light | (8) VarioSpace |
| (3) NoFrost equipment | (9) Type plate |
| (4) Freezer pack | (10) Height-adjustable feet |
| (5) Information system | (11) Soft stop mechanism |
| (6) IceMaker | |

Note

- Shelves, drawers and baskets are arranged for optimum energy efficiency on delivery.

1.2 Appliance range of use

Intended use

The appliance is only suitable for cooling food products in a domestic or household-like environment. This includes, for example, use:

- in staff kitchens, bed and breakfast establishments,
- by guests in country houses, hotels, motels and other accommodation,
- for catering and similar services in the wholesale trade.

All other types of use are not permitted.

Foreseeable misuse

The following applications are expressly forbidden:

- Storing and refrigerating medicines, blood plasma, laboratory preparations or similar substances and products based on the Medical Device Directive 2007/47/EC
- Use in areas at risk of explosions

Misusing the appliance may lead to damage to the goods stored or they may spoil.

Climate classifications

Depending on the climate classification the appliance is designed to operate in restricted ambient temperatures. The climate classification applying to your appliance is printed on the rating plate.

Note

- Keep to the specified ambient temperatures in order to guarantee that the appliance works properly.

Climate classification	for ambient temperatures
SN, N	to 32 °C
ST	to 38 °C
T	to 43 °C

The appliance will work properly down to a lower ambient temperature of 5 °C.

1.3 Conformity

The refrigerant circuit has been tested for leaks. In installed condition, this appliance complies with the applicable safety stipulations and with directives 2014/35/EU, 2014/30/EU, 2009/125/EG, 2011/65/EU and 2010/30/EU.

1.4 Product data

Product data is included with the appliance, as per Directive (EU) 2017/1369. The complete product data sheet is available on the Liebherr website under Downloads.

1.5 EPREL database

Details about energy labelling and ecodesign requirements will be available on the European product database (EPREL) from 1st March 2021. You can access the product database at the following link: <https://eprel.ec.europa.eu/> You will be asked to enter the model ID. You can find the model ID on the nameplate.

1.6 Saving energy

- Pay attention to good ventilation. Do not cover ventilation holes or grids.
- Always keep the fan air slits clear.
- Do not install the appliance in direct sunlight, next to an oven, radiator or similar.
- Energy consumption depends on the installation conditions, e.g. the ambient temperature (see 1.2 Appliance range of use) . A warmer ambient temperature can increase the energy consumption.

- Open the appliance for as short a time as possible.
- The lower the temperature is set the higher the energy consumption.
- Keep all food properly packed and covered. This prevents frost from forming.
- Inserting warm food: allow to cool down to room temperature first.

2 General safety information

Danger for the user:

- This device can be used by children and people with impaired physical, sensory or mental abilities or with a lack of experience and knowledge provided that they are supervised or have received instruction in the safe use of this device, and about the resulting hazards. Children must not play with this appliance. Cleaning and user maintenance work must not be carried out by children without adult supervision. Children aged between 3 and 8 are allowed to load and unload the appliance. Children below the age of 3 must be kept away from the appliance unless they are under continuous adult supervision.
- When disconnecting the appliance from the supply, always take hold of the plug. Do not pull the cable.
- In the event of a fault pull out the mains plug or deactivate the fuse.
- Do not damage the mains power cable. Do not operate the appliance with a defective mains power cable.
- Repairs, interventions on the appliance and the replacement of mains connection line may only be carried out by After-Sales Service or other suitably trained specialist personnel.
- Only install, connect and dispose of the appliance according to the instructions.
- Only use the appliance when it is installed.
- Please keep these instructions in a safe place and pass them on to any subsequent owners.
- The manufacturer is not liable for damage caused by a faulty fixed water connection.

Fire hazard:

- The coolant used (information on the model plate) is eco-friendly but also flammable. Any leaking coolant may ignite.
 - Do not damage the refrigerant circuit pipes.
 - Do not handle ignition sources inside the appliance.
 - Do not use electrical appliances inside the appliance (e.g. steam cleaners, heaters, ice cream makers, etc.).
 - If the refrigerant leaks: remove any naked flames or ignition sources from the vicinity

Controls and displays

of the leakage point. Properly air the room. Inform customer services.

- Do not store explosives or sprays using combustible propellants such as butane, propane, pentane, etc. in the appliance. To identify these spray cans, look for the list of contents printed on the can, or a flame symbol. Gases possibly escaping may ignite due to electrical components.
- Please be sure to store alcoholic drinks or other packaging containing alcohol in tightly closed containers. Any alcohol that leaks out may be ignited by electrical components.

Danger of tipping and falling:

- Do not misuse the plinth, drawers, doors etc. as a step or for support. This applies particularly to children.

Danger of food poisoning:

- Do not consume food which has been stored too long.

Danger of frostbite, numbness and pain:

- Avoid prolonged skin contact with cold surfaces or refrigerated/frozen goods or take protective measures, e.g wear use gloves.

Danger of injury and damage:

- Hot steam can lead to injury. Do not use electrical heating or steam cleaning equipment, open flames or defrosting sprays to defrost.
- Do not use sharp implements to remove the ice.

Danger of crushing:

- Do not hold the hinge when opening and closing the door. Fingers may get caught.

Symbols on the appliance:



The symbol can be located on the compressor. It refers to the oil in the compressor and indicates the following danger: Swallowing or inhaling can be fatal. This is only relevant for recycling. There is no danger in normal operation.



This symbol is found on the compressor and indicates the danger of flammable materials. Do not remove the sticker.



A sticker to this effect may be applied to the rear of the appliance. It refers to the foam-padded panels in the door and/or the housing. This is only relevant for recycling. Do not remove the sticker.

Please observe the specific information in the other sections:

	DANGER	identifies a situation involving direct danger which, if not obviated, may result in death or severe bodily injury.
	WARNING	identifies a dangerous situation which, if not obviated, may result in death or severe bodily injury.
	CAUTION	identifies a dangerous situation which, if not obviated, may result in minor or medium bodily injury.
	NOTICE	identifies a dangerous situation which, if not obviated, may result in damage to property.
	Note	It contains useful instructions and tips.

3 Controls and displays

3.1 Operating and control elements

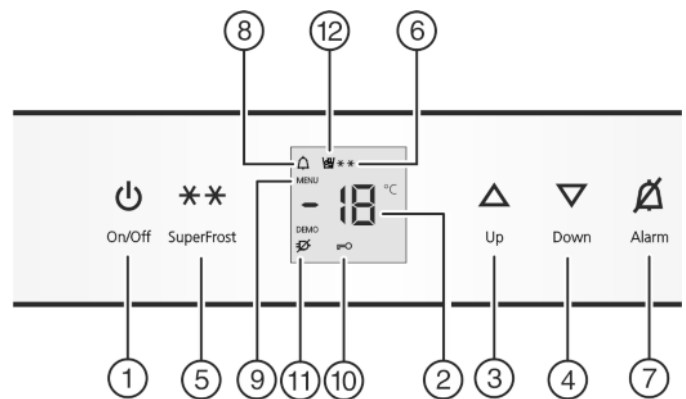

Fig. 2

- | | |
|-------------------------|---------------------------|
| (1) On/Off button | (7) Alarm button |
| (2) Temperature display | (8) Alarm symbol |
| (3) Up button | (9) Menu symbol |
| (4) Down button | (10) Child lock symbol |
| (5) SuperFrost button | (11) Power failure symbol |
| (6) SuperFrost symbol | (12) IceMaker symbol |

3.2 Temperature display

During normal operation, the display shows:

- the highest freezing temperature

The temperature display flashes if/when:

- You change the temperature setting
- The appliance is not cold enough after switching on
- The temperature rises by several degrees

Stripes flash in the display if/when:

- The freezer temperature exceeds 0 °C.

The following displays indicate a fault. Possible causes and solutions: (see 7 Malfunctions) .

- **F0 to F9**
- The power failure symbol flashes.

4 Putting into operation

4.1 Switching on the appliance

Note

The manufacturer recommends:

- ▶ Store frozen produce at -18 °C or colder.

Switch on the appliance approx. 2 hours before loading for the first time.

- ▶ Open the door.
- ▶ Press On/Off button *Fig. 2 (1)*.
- ▷ The temperature display and the alarm symbol flash until the temperature is sufficiently low. If the temperature is above 0 °C, dashes flash. If it is below, the current temperature flashes.
- ▷ The interior light is on when the door is open.
- ▷ If "DEMO" is displayed, demo mode is activated. Please contact the after sales service.

5 Control

5.1 Child proofing

The child-proofing function enables you to make sure that the appliance is not inadvertently switched off by playing children.



5.1.1 Setting the child lock function

- ▶ To activate the setting mode: press SuperFrost button *Fig. 2 (5)* for about 5 s.
 - ▷ **c** flashes on the display.
 - ▷ The menu symbol *Fig. 2 (9)* shines.
 - ▶ Briefly press the SuperFrost button *Fig. 2 (5)* to confirm. When **cl** is indicated in the display:
 - ▶ To activate the child lock, briefly press the SuperFrost button *Fig. 2 (5)*.
 - ▷ The child lock symbol *Fig. 2 (10)* shines. **c** flashes in the display.
 - When **cl** is indicated in the display:
 - ▶ to deactivate the child lock, briefly press the SuperFrost button *Fig. 2 (5)*.
 - ▷ The child lock symbol *Fig. 2 (10)* goes out. **c** flashes in the display.
 - ▶ To deactivate the set-up mode: press On/Off button *Fig. 2 (1)*.
- or-**
- ▶ Wait for 5 minutes.
 - ▷ The temperature is indicated again in the temperature display.

5.2 Door alarm

An audible warning sounds if the door is open for longer than 60 seconds.

The audible warning stops automatically when the door is closed.



5.2.1 Muting the door alarm

The audible alarm can be muted when the door is open. The sound switch-off function is active as long as the door is left open.

- ▶ Press alarm button *Fig. 2 (7)*.
- ▷ The door alarm is silenced.

5.3 Temperature alarm

The audible alarm sounds if the freezer temperature is not cold enough.

The temperature display and the alarm symbol *Fig. 2 (8)* flash at the same time.



EN

The cause of the temperature being too high may be:

- warm fresh food was placed inside
- too much warm ambient air flowed in when rearranging and removing food
- Prolonged power outage
- the appliance is faulty

The audible alarm is automatically silenced, the alarm symbol *Fig. 2 (8)* goes out and the temperature display stops flashing when the temperature is sufficiently cold again.

If the alarm status persists: (see 7 Malfunctions) .

Note

Food may be spoiled if the temperature is not cold enough.

- ▶ Check the quality of the food. Do not consume spoiled food.

5.3.1 Muting the temperature alarm

The audible alarm can be muted. When the temperature is sufficiently cold again, the alarm function is active again.

- ▶ Press alarm button *Fig. 2 (7)*.
- ▷ The audible alarm is silenced.

5.4 Freezing food

The rating plate indicates the maximum quantity of fresh food you can freeze within 24 hours (see 1 Appliance at a glance) under "Freezing capacity ... kg/24h".

The maximum load for the top drawer is 5 kg and for the other drawers 25 kg each.

The shelves can each be loaded with 35 kg of frozen food.

A vacuum is generated after the door is closed. After closing the door, wait for about 1 minute and then it opens more easily.



CAUTION

Risk of injury due to broken glass!

Bottles and cans containing drinks may burst when being frozen. This applies particularly to sparkling drinks.

- ▶ Do not freeze bottles and cans containing drinks!

So that the food is rapidly frozen through to the core, do not exceed the following quantities per pack

- Fruit, vegetables up to 1 kg
- Meat up to 2.5 kg
- ▶ Pack the food in portions in freezer bags, reusable plastic, metal or aluminium containers

5.5 Thawing food

- in the refrigerator compartment
- in a microwave oven
- in a conventional or fan oven
- at room temperature
- ▶ Remove only as much food as is required. Use thawed food as quickly as possible.
- ▶ Food once thawed should be re-frozen only in exceptional cases.

5.6 Setting the temperature

The appliance is pre-set for normal operation.

Control

The temperature can be set between -14 °C and -26 °C, the recommended temperature is -18 °C.

- ▶ To set the temperature higher: press Up button *Fig. 2 (3)*.
- ▶ To set the temperature lower: press Down button *Fig. 2 (4)*.
- ▷ When the button is pressed the first time, the previous value is indicated in the temperature display.
- ▶ To change the temperature in 1 °C steps: briefly press the button.

-or-

- ▶ To change the temperature continuously: hold down the button.
- ▷ The value is displayed flashing during the setting operation.
- ▷ The actual temperature is displayed approx. 5 seconds after the button is last pressed. The temperature gradually adjusts to the new value.

5.7 SuperFrost

With this function you can freeze fresh food quickly through to the core. The appliance operates with maximum refrigeration. The noise of the refrigeration unit may be temporarily louder as a result. * *

You can freeze as many kilograms of fresh food within 24 hrs as is indicated on the type plate under "Freezing capacity ... kg/24hrs". This maximum freezing quantity can vary depending on model and climate class.

You have to activate SuperFrost in good time, depending on how much fresh food is to be frozen: about 6 hours before placing the food inside in case of small amounts and about 24 hours in advance in case of the maximum amount of food to be frozen.

Wrap produce and spread it out as far as possible. Do not allow produce to be frozen to touch produce that is already frozen to prevent the latter thawing.

You do not have to activate SuperFrost in the following cases:

- when placing frozen food in the freezer
- when freezing up to approx. 2 kg fresh food daily

5.7.1 Freezing with SuperFrost

- ▶ Briefly press the SuperFrost button *Fig. 2 (5)* once.
- ▷ The SuperFrost symbol *Fig. 2 (6)* shines.
- ▷ The freezing temperature drops, the appliance operates with the maximum cooling capacity.
For a smaller quantity of produce to be frozen:
 - ▶ wait approx. 6 h.
 - ▶ Place wrapped produce in the deep bottom drawers.For the maximum quantity of produce to be frozen:
 - ▶ wait approx. 24 h.
 - ▶ Remove the deep bottom drawers and place produce directly on the bottom shelves.
- ▷ SuperFrost is automatically deactivated. Depending on the quantity placed inside, after 30 h at the earliest, 65 h at the latest.
- ▷ The SuperFrost symbol *Fig. 2 (6)* extinguishes once freezing is completed.
- ▶ Place produce in the drawers and push the latter back in again.
- ▷ The appliance continues to operate in the energy-saving, normal mode.

5.8 Drawers

Note

The energy consumption increases and the cooling performance reduces if the air ventilation is insufficient.

- ▶ Ensure that the air slits of the fan on the rear wall are always kept free!

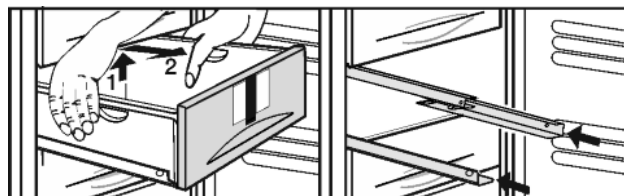

Fig. 3

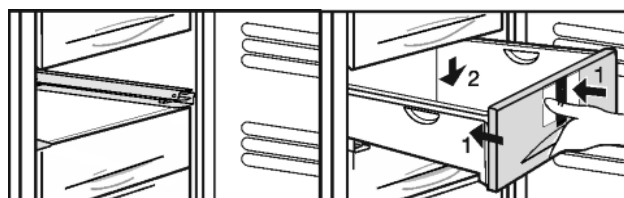

Fig. 4

- ▶ To store frozen food directly on the shelves Lift the drawer at the back, pull it forwards to remove.

5.9 Shelves

5.9.1 Moving shelves

- ▶ To remove the shelf: lift up at the front and pull out.
- ▶ To put the shelf back: simply push in as far as it will go.

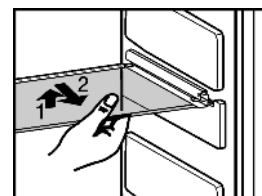

5.10 VarioSpace

You can remove the shelves and drawers. This leaves more room for larger food items such as poultry, meat, large game and tall baked goods, which can be frozen whole before further preparation.

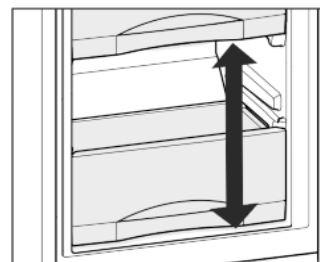

- ▶ The maximum load for the top drawer is 5 kg and for the other drawers 25 kg each.
- ▶ The shelves can each be loaded with 35 kg of frozen food.

5.11 Extractor rails

- ▶ To clean the glass racks, remove the **retractable rails**: press front support hooks upwards (1), slide the retractable rail away to one side (2) and backwards (3).
- ▶ Replacing the retractable rail: attach hook at back (1) and engage at front (2).

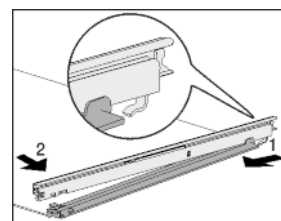
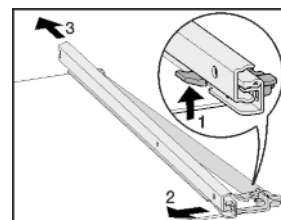

5.12 Information system

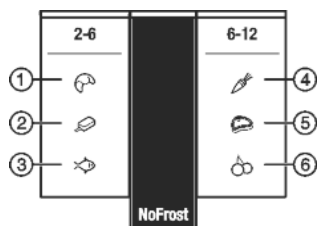

Fig. 5

- | | |
|---------------|----------------|
| (1) Bread | (4) Vegetables |
| (2) Ice cream | (5) Meat |
| (3) Fish | (6) Fruit |

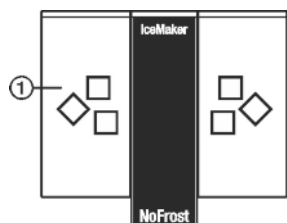

Fig. 6

- (1) Ice cubes*

The figures indicate the storage time in months for several types of frozen food in each case. Storage times given are guide times.

5.13 Ice cube tray*

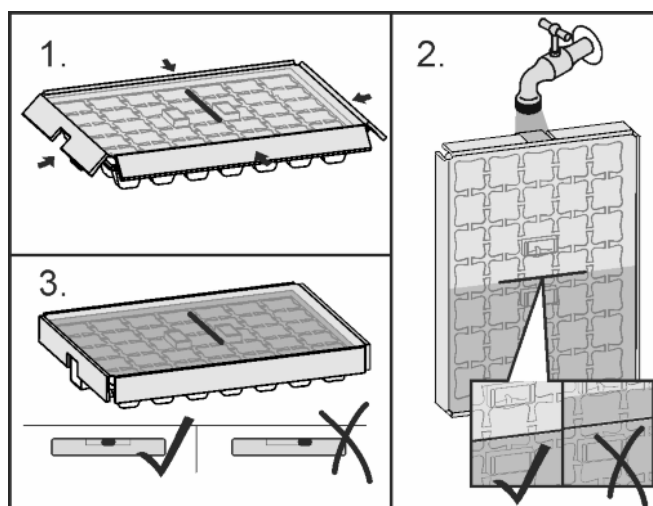

Fig. 7

When the water is frozen:

- ▶ Hold ice cube tray under hot water for a short time.
- ▶ Remove the lid.
- ▶ Gently turn the ends of the ice cube tray in opposite directions and release the cubes.

Dismantling the ice cube tray

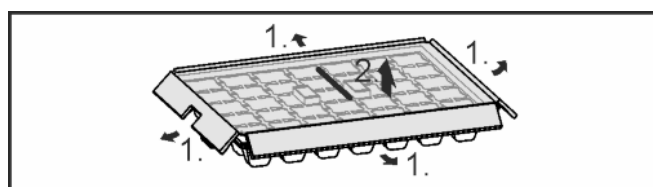

Fig. 8

- ▶ You can take the ice cube tray apart for cleaning.

5.14 Freezer pack

Freezer packs prevent the temperature rising too quickly should there be a power cut.

5.14.1 Using freezer packs

- ▶ Put the fully frozen freezer packs on the frozen food in the top front section of the freezer compartment.

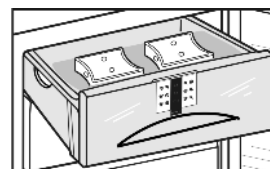

EN

5.15 IceMaker*

The IceMaker is in the fifth drawer from the top. The drawer is "marked" IceMaker.

Make certain that the following conditions are met:

- The appliance is level.
- The appliance is connected.
- The IceMaker is connected to the water supply.

5.15.1 Switching on the IceMaker*

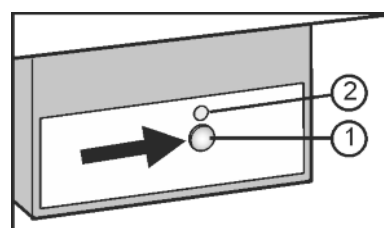

Fig. 9

- ▶ Pull out the drawer.
- ▶ Press the On/Off button Fig. 9 (1) so that the LED Fig. 9 (2) shines.
- ▶ Push in the drawer.
- ▷ The IceMaker symbol Fig. 2 (12) shines.

Note

- ▶ The IceMaker produces ice cubes only if the drawer is fully closed.

5.15.2 Producing ice cubes*

The production capacity depends on the freezer temperature. The lower the temperature, the more ice cubes can be produced in a specific period.

The ice cubes drop from the IceMaker into the drawer. When a certain filling level has been reached, no further ice cubes are produced. The IceMaker does not fill the drawer right up to the brim.

Distribute the ice cubes evenly in the drawer to increase the capacity.

If large quantities of ice cubes are needed, the complete IceMaker drawer can be exchanged for the adjacent drawer. When the drawer is closed, the IceMaker automatically recommences production.

Once the IceMaker has been switched on for the first time, it may take up to 24 hours until the first ice cubes are produced.

Note

When the appliance is used for the first time and if it has been out of use for a long time, particles may collect in the IceMaker and/or water conduit.

- ▶ Do not use or consume ice cubes that have been made 24 hours after the first ice cubes are made.

5.15.3 Setting the water intake time*

The opening time of the IceMaker valve can be set if, for example, the water pressure in the pipe is too low or too high.

The water intake time can be set in stages from **E1** (short intake time) to **E8** (long intake time). The intake is preset at **E3**.

Maintenance

- ▶ To activate the setting mode: press the SuperFrost button *Fig. 2 (5)* for about 5 s.
- ▷ The display indicates **c**.
- ▷ The menu symbol *Fig. 2 (9)* shines.
- ▶ Using the Up setting button *Fig. 2 (3)* or Down setting button *Fig. 2 (4)* select **E**.
- ▶ To confirm: briefly press the SuperFrost button *Fig. 2 (5)*.
- ▶ To increase the water intake time: press the Up setting button *Fig. 2 (3)*.
- ▶ To reduce the water intake time: press the Down setting button *Fig. 2 (4)*.
- ▶ To confirm: press the SuperFrost button *Fig. 2 (5)*.
- ▶ To deactivate the setting mode: press the On/Off button *Fig. 2 (1)*.

-or-

- ▶ Wait for 5 minutes.
- ▷ The temperature is indicated again in the temperature display.

5.15.4 Switching off the IceMaker*

If no ice cubes are needed, the IceMaker can be switched off independently of the freezer compartment.

When the IceMaker is switched off, the IceMaker drawer can also be used for freezing and storing food.

- ▶ Press the On/Off button for about 1 second until the LED goes out.
- ▷ The IceMaker symbol *Fig. 2 (12)* goes out.
- ▶ Clean the IceMaker.
- ▷ This ensures that no water or ice remains in the IceMaker.

6 Maintenance

6.1 Defrosting with NoFrost

The NoFrost system automatically defrosts the appliance.

The moisture condenses on the evaporator, is periodically defrosted and evaporates.

- ▶ The appliance does not have to be manually defrosted.

6.2 Cleaning the appliance

Clean the appliance regularly.



WARNING

Risk of injury and damage as a result of hot steam!
Hot steam can lead to burns and can damage the surfaces.

- ▶ Do not use any steam cleaners!

NOTICE

Incorrect cleaning damages the appliance!

- ▶ Do not use cleaning agents in concentrated form.
- ▶ Do not use any scouring or abrasive sponges or steel wool.
- ▶ Do not use any sharp or abrasive cleaning agents, nor any that contain sand, chloride or acid.
- ▶ Do not use chemical solvents.
- ▶ Do not damage or remove the type plate on the inside of the appliance. It is important for the customer service.
- ▶ Do not pull off, bend or damage cables or other components.
- ▶ Do not allow any cleaning water to enter the drain channel, ventilation grille or electrical parts.
- ▶ Please use soft cleaning cloths and a universal pH-neutral cleaning agent.
- ▶ Please use cleaning and care products suitable for contact with foodstuffs in the appliance interior.

- ▶ **Empty appliance.**
- ▶ **Pull out the power plug.**



- ▶ Clean the **vent grille** regularly.
- ▷ Dust deposits increase energy consumption.
- ▶ Clean **plastic outer and inner surfaces** with lukewarm water and a little washing-up liquid.
- ▶ Most of the **parts** can be dismantled for cleaning: see the relevant chapter.
- ▶ **Clean drawers** by hand with lukewarm water and a little washing up liquid.
- ▶ Clean **other items of equipment** by hand with lukewarm water and a little washing-up liquid.
- ▶ Only use a damp cloth to clean the **telescopic rails**. The grease in the runners is for lubrication purposes and must not be removed.

After cleaning:

- ▶ Wipe dry the appliance and items of equipment.
- ▶ Connect the appliance and switch it on again.
- ▶ Switch on SuperFrost (see 5.7 SuperFrost) .
When the temperature is sufficiently cold:
- ▶ Put the food back inside.

6.3 Cleaning the IceMaker*

The drawer of the IceMaker has to be emptied and slid in.

- ▶ To activate the setting mode: press the SuperFrost button *Fig. 2 (5)* for about 5 s.
- ▷ The display indicates **c**.
- ▷ The menu symbol *Fig. 2 (9)* shines.
- ▶ Using the Up setting button *Fig. 2 (3)*/ Down setting button *Fig. 2 (4)* select **I**.
- ▶ To confirm: press the SuperFrost button *Fig. 2 (5)*.
- ▶ Using the Up setting button *Fig. 2 (3)*/ Down setting button *Fig. 2 (4)* select **Ic**.
- ▶ To confirm: press the SuperFrost button *Fig. 2 (5)*.
- ▷ The IceMaker moves into the cleaning position and switches off.
- ▶ To deactivate the setting mode: press the On/Off button *Fig. 2 (1)*.

-or-

- ▶ Wait for 2 minutes.
- ▷ The temperature is indicated again in the temperature display.
- ▶ Remove the drawer.
- ▶ Clean the ice cube tray and drawer with warm water. If necessary, use mild washing-up liquid. Then rinse.
- ▶ Slide in the drawer again.
- ▶ Leave the IceMaker switched off in this position.

-or-

NOTICE

Rinse agent residue in the ice compartment and drawer.
Nausea or irritation of the mucous membrane.

- ▶ Remove rinse agent residue: Discard the first three batches of ice cubes.

- ▶ Switch the IceMaker on (see 5.15 IceMaker*) .

6.4 Customer service

First check whether you can correct the fault yourself by reference to the list (see 7 Malfunctions) . If this is not the case, please contact the customer service whose address is given in the enclosed customer service list.

**WARNING**

Risk of injury if repair work is not carried out professionally!

- ▶ Have any repairs and action - not expressly specified - on the appliance and mains cable carried out by service personnel only. (see 6 Maintenance)

- ▶ Read the appliance designation *Fig. 10 (1)*, service No. *Fig. 10 (2)* and serial No. *Fig. 10 (3)* off the type plate located inside the appliance on the left-hand side.

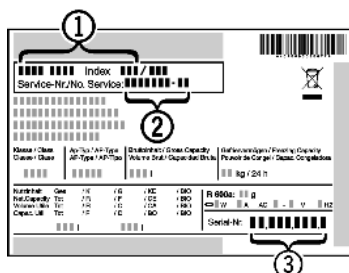

Fig. 10

- ▶ Notify the customer service, specifying the fault, appliance designation *Fig. 10 (1)*, service No. *Fig. 10 (2)* and serial No. *Fig. 10 (3)*.
- ▷ This will help us to provide you with a faster and more accurate service.
- ▶ Keep the appliance closed until the customer service arrives.
- ▷ The food will stay cool longer.
- ▶ Pull out the mains plug (not by pulling the connecting cable) or switch off the fuse.

7 Malfunctions

Your appliance is designed and manufactured for a long life span and reliable operation. If a malfunction nonetheless occurs during operation, check whether it is due to a handling error. In this case you will have to be charged for the costs incurred, even during the warranty period. You may be able to rectify the following faults yourself:

Appliance does not work.

- The appliance is not switched on.
- ▶ Switch on the appliance.
- The power plug is not properly inserted in the wall socket.
- ▶ Check power plug.
- The fuse of the wall socket is not in order.
- ▶ Check fuse.

The compressor runs for a long time.

- The compressor switches to a low speed when little cold is needed. Although the running time is increased as a result, energy is saved.
- ▶ This is normal in energy-saving models.
- SuperFrost is activated.
- ▶ The compressor runs for longer in order to rapidly cool the food. This is normal.

A LED on the bottom rear of the appliance (at the compressor) flashes repeatedly every 5 seconds*.

- There is a fault.
- ▶ Please contact the after-sales service (see 6 Maintenance).

Excessive noise.

- Due to the various speed steps, speed-regulated* compressors can generate different running noises.
- ▶ The sound is normal.

A bubbling and gurgling noise.

- This noise comes from the refrigerant flowing in the refrigeration circuit.
- ▶ The sound is normal.

A quiet clicking noise.

- The noise is produced whenever the refrigeration unit (motor) automatically switches on or off.
- ▶ The sound is normal.

A hum. It is briefly a little louder when the refrigeration unit (the motor) switches on.

- The refrigeration increases automatically when the SuperFrost, function is activated, fresh food has just been placed in the appliance or the door has been left open for a while.
- ▶ The sound is normal.
- The ambient temperature is too high.
- ▶ Solution: (see 1.2 Appliance range of use)

A low hum.

- The sound is produced by air flow noise of the fan.
- ▶ The sound is normal.

Vibration noises

- The appliance is not standing firmly on the floor. As a result objects and adjacent units start to vibrate when the refrigerator is running.
- ▶ Check the installation and realign the appliance.

Flow sound at the soft stop mechanism.

- The noise is produced when the door is opened and closed.
- ▶ The sound is normal.

The temperature display indicates: F0 to F9

- There is a fault.
- ▶ Please contact the after-sales service (see 6 Maintenance).

Power failure flashes in the temperature display . The highest temperature reached during power failure is indicated in the temperature display.

- The freezer temperature rose too high over the last hours or days due to a power failure or power interruption. When the power interruption is over, the appliance will continue to operate in the last temperature setting.
- ▶ To cancel the display of the warmest temperature: press alarm button *Fig. 2 (7)*.
- ▶ Check the quality of the food. Do not consume spoiled food. Do not re-freeze thawed food.

DEMO shines in the temperature display.

- The demo mode is activated.
- ▶ Please contact the after-sales service (see 6 Maintenance).

The outer surfaces of the appliance are warm*.

- The heat of the refrigeration circuit is used to prevent condensate from forming.
- ▶ This is normal.

The IceMaker cannot be switched on.*

- The appliance and therefore the IceMaker are not connected.
- ▶ Connect the appliance to the mains (see 4 Putting into operation).

The IceMaker does not make any ice cubes.*

- The IceMaker is not switched on.
- ▶ Switch on the IceMaker.
- The drawer of the IceMaker is not properly closed.
- ▶ Close the drawer properly.
- The water connection is not open.
- ▶ Open the water connection.
- The water intake to the IceMaker has been interrupted.
- ▶ Check the water connection (see **Water Connection in the Fitting Instructions**).
- ▶ Check the hosing (see **Water Connection in the Fitting Instructions**).

Decommissioning

→ The screen located in the end piece of the water intake hose or the screen located in the connecting piece on the appliance is blocked.

- ▶ Clean the screens.

The temperature is not cold enough.

→ The door of the appliance is not properly closed.

- ▶ Close the door of the appliance.

→ Insufficient ventilation.

- ▶ Keep ventilation grille clear, and clean it.

→ The ambient temperature is too high.

- ▶ Solution: (see 1.2 Appliance range of use) .

→ The appliance was opened too frequently or for too long.

- ▶ Wait to see whether the appliance reaches the required temperature by itself. If not, please contact the after sales service (see 6 Maintenance) .

→ Too much fresh food was placed inside without SuperFrost.

- ▶ Solution: (see 5.7 SuperFrost)

→ The temperature is incorrectly set.

- ▶ Set the temperature to a colder setting and check after 24 hours.

→ The appliance is too close to a source of heat (stove, heater etc).

- ▶ Change the position of the appliance or the source of heat.

→ The appliance was not inserted properly into the recess.

- ▶ Check whether the appliance was inserted correctly and the door closes properly.

Dashes ("-") are shown on the display.

→ The freezing temperature has risen above zero degrees because of a power cut or power interruption.

- ▶ See also "Power failure" and "

The internal light does not come on.

→ The appliance is not switched on.

- ▶ Switch the appliance on.

→ The door was open for longer than 15 minutes.

- ▶ The internal light switches itself off automatically after about 15 minutes if the door is open.

→ The LED illumination is faulty or the cover is damaged:



WARNING

Risk of injury due to electric shock!

There are live electrical parts under the cover.

- ▶ Only ever have the inside LED light replaced or repaired by customer service or trained personnel.



WARNING

Risk of injury from LED bulb!

The light intensity of the LED light corresponds to hazard group RG 2.

If the cover is defective:

- ▶ Do not look directly into the light from close range. It cause injury to the eyes.

The door gasket is defective or should be replaced for other reasons.*

→ In some units, the seal around the door can be replaced. You will not need any special tools to do this.

- ▶ Please contact the after-sales service (see 6 Maintenance) .

The unit has iced up or condensation has formed.*

→ The door seal may have also slipped out of its groove.

- ▶ Check to ensure that the door seal is seated properly in the groove.

8 Decommissioning

8.1 Shut off the water intake*

NOTICE

Malfunction of the water intake!

If the water intake is shut off during operation but the IceMaker remains in operation, the water intake pipe may ice up.

- ▶ Switch off the IceMaker if the water supply is interrupted (e.g. holiday).

8.2 Switching off the appliance

- ▶ Press On/Off button *Fig. 2 (1)* for approx. 2 seconds.
 - ▷ A long beep is emitted. The temperature display is dark. The appliance is switched off.
- ▶ If the appliance cannot be switched off, the child lock function is active (see 5.1 Child proofing) .

8.3 Taking the appliance out of service

- ▶ Empty the appliance.
- ▶ Put the IceMaker in the cleaning position (see 6 Maintenance) .*
- ▶ Switch off the appliance (see 8 Decommissioning) .
- ▶ Remove mains connector.
- ▶ Clean the appliance (see 6.2 Cleaning the appliance) .



- ▶ Leave the door open to prevent odour.

9 Disposing of the appliance

The appliance contains some reusable materials and should be disposed of properly - not simply with unsorted household refuse. Appliances which are no longer needed must be disposed of in a professional and appropriate way, in accordance with the current local regulations and laws.



When disposing of the appliance, ensure that the refrigeration circuit is not damaged to prevent uncontrolled escape of the refrigerant it contains (data on type plate) and oil.

- ▶ Disable the appliance.
- ▶ Pull out the plug.
- ▶ Cut through the connecting cable.



Liebherr-Hausgeräte Ochsenhausen GmbH

Memminger Straße 77-79

88416 Ochsenhausen

Deutschland

home.liebherr.com