

EN

Operating instructions

Freezer

Read the operating instructions before switching on for the first time

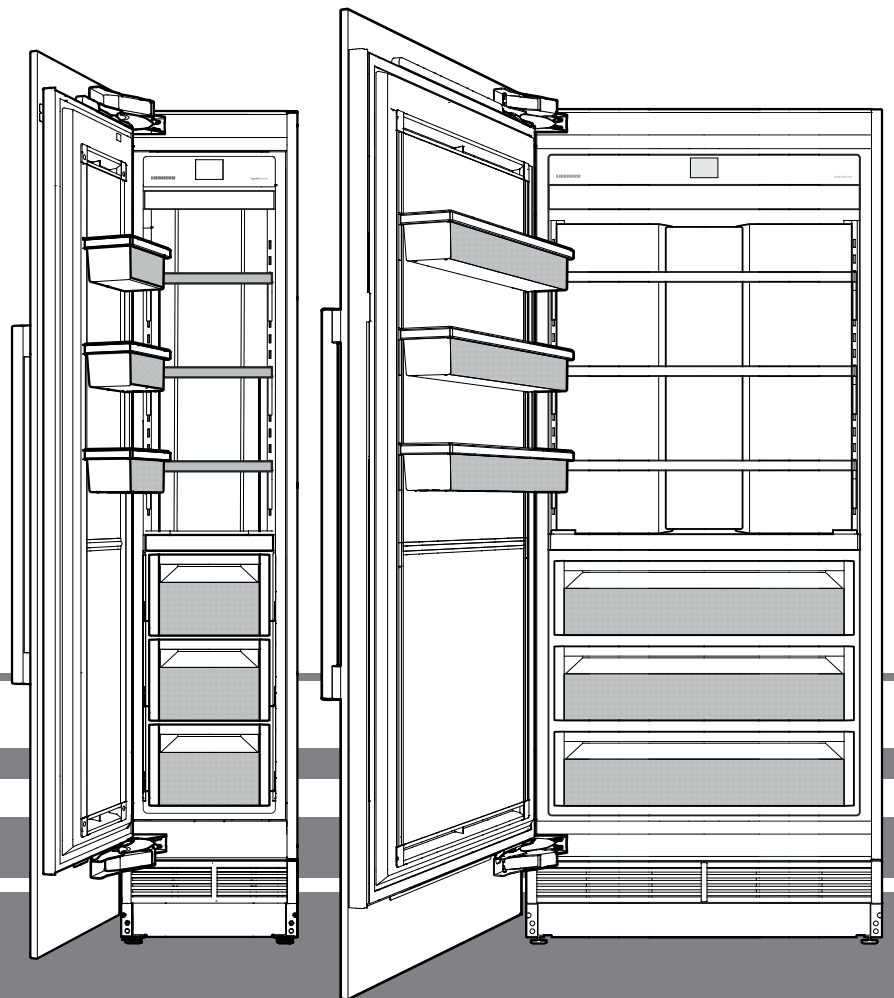

7082 943-00

EGN 91 / EGN 92 / EGN 94 / EGN 96

LIEBHERR

- This appliance can be used by children of 8 years old and over, and also by persons with restricted physical, sensory or mental capacity or lack of experience and knowledge if they are supervised or have been instructed on the safe use of the appliance and understand the resulting risks. Children must not be allowed to play with the appliance. Cleaning and user maintenance must not be carried out by children without supervision.
- Avoid prolonged skin contact with cold surfaces or chilled/frozen food. This could cause pain, numbness and frostbite. In the case of prolonged skin contact, protective measures should be taken, e.g. gloves should be worn.
- Do not consume food which has been stored for too long, as it could cause food poisoning.
- Do not store any explosive substances, such as aerosol containers with flammable propellant gas, inside the appliance.
- Do not store explosives or sprays using flammable propellants such as butane, propane, pentane, etc. in the appliance. Electrical components might cause leaking gas to ignite. You may identify such sprays by the printed contents or a flame symbol.
- If you have a lockable appliance, do not keep the key near the appliance or within reach of children.
- The appliance is designed for use in enclosed areas. Do not operate the appliance outdoors or in areas where it is exposed to splash water or damp conditions.
- The LED lights illuminate the interior of the appliance. They are not suitable for lighting a room.

Safety instructions and warnings

- **WARNING:** do not seal ventilation openings on the appliance housing or enclosure.
- **WARNING:** only use the mechanical devices or other aids recommended by the manufacturer to help speed up the defrosting process.
- **WARNING:** do not damage the refrigerant circuit.
- **WARNING:** the mains cable must not be damaged while installing the appliance.
- **WARNING:** multi-sockets or distributor strips and other electronic devices (such as halogen transformers) must not be positioned and operated at the rear of appliances.
- **WARNING:** danger of injury through electric shock. There are live parts under the cover. Only have the interior LED light replaced or repaired by customer service staff or trained personnel.
- **WARNING:** ensure that the refrigerant circuit pipes will not be damaged.
- **WARNING:** do not use any electrical devices inside the appliance.
- To prevent injury or damage to the unit, the appliance should be unpacked and set up by four people.
- In the event that the appliance is damaged on delivery, contact the supplier immediately before connecting to the mains.
- To guarantee safe operation, ensure that the appliance is set up and connected as described in these operating instructions.
- Disconnect the appliance from the mains if any fault occurs. Pull out the plug, switch off or remove the fuse.
- When disconnecting the appliance, pull on the plug, not on the cable.
- Any repairs and work on the appliance should only be carried out by the customer service department, as unauthorised work could prove highly dangerous for the user. The same applies to changing the mains power cable.
- Do not allow naked flames or ignition sources to enter the appliance. When transporting and cleaning the appliance ensure that the refrigerant circuit is not damaged. In the event of damage, make sure that there are no ignition sources nearby and keep the room well ventilated.
- Do not stand on the plinth, drawers or doors or use them to support anything else.

Climate rating

The climate rating indicates the room temperature at which the appliance may be operated in order to achieve full refrigeration performance.

The climate rating is indicated on the type plate.

The position of the type plate is shown in the section entitled **Description of the appliance**.

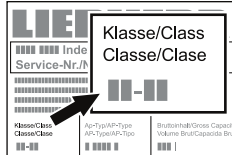

Climate rating	Room temperature
SN	+10°C to +32°C
N	+16°C to +32°C
ST	+16°C to +38°C
T	+16°C to +43°C
SN-ST	+10°C to +38°C
SN-T	+10°C to +43°C

Do not operate the appliance outside the specified room temperature range.

EPREL database:

As from 1 March 2021, information about energy labelling and ecodesign requirements will be available in the European product database (EPREL). You can access the product database using the following link: <https://eprel.ec.europa.eu/>. You will be asked to enter the model identifier. You will find the model identifier on the type plate.

IMPORTANT

All types and models are subject to continuous improvement. The manufacturer reserves the right to make modifications to the shape, equipment and technology.

Symbols on the appliance:

	This symbol may be located on the compressor. It relates to the oil in the compressor and makes reference to the risk that: Swallowing or inhaling can be fatal. This advice is only relevant to recycling. There is no danger in normal operation.
	This symbol is located on the compressor and indicates the danger of flammable materials. Do not remove the sticker.
	This or a similar sticker may be located on the rear of the appliance. This sticker indicates that there are vacuum insulation panels (VIP) or perlite panels in the door and/or housing. This advice is only relevant to recycling. Do not remove the sticker.

Content

Safety instructions and warnings	26
Content.....	27
Climate rating	27
EPREL database:	27
Symbols on the appliance:	27
Disposal notes.....	28
Description of the appliance.....	28
Range of appliance use.....	28
Control panel.....	29
Switching the appliance on	29
Changing language and temperature unit.....	29
Main menu.....	30
Setting the temperature.....	30
SuperFrost.....	31
Notes on freezing	31
Safety instructions and warnings for the IceMaker	32
IceMaker description.....	32
Switching the IceMaker on	32
Switching the IceMaker off	33
Switching the IceMaker to maximum ice production.....	33
PartyMode.....	34
SabbathMode.....	34
Switching the appliance off	35
Maintenance message	35
Maintenance confirmation.....	36
Setup menu	36
SmartDeviceBox (not supplied in all countries).....	38
Description of the SmartDevice display	39
Alarm messages	39
Equipment	42
Interior light.....	42
Cleaning	43
Maintenance menu.....	44
Maintenance.....	45
Additional functions.....	46
Saving energy	49
Malfunctions.....	49
Shutting your appliance down.....	49

DANGER!

Danger indicates an imminent hazard which will cause serious injury or death if precautions are not followed.

WARNING!

Warning indicates a hazardous situation which, if not avoided, could result in death or serious injury.

CAUTION!

Caution indicates a potentially hazardous situation which, if not avoided, may result in minor or moderate injury.

IMPORTANT

This indicates information that is especially relevant to a problem-free installation and operation.

Disposal notes

The appliance contains reusable materials and should be disposed of properly - not simply with unsorted household refuse. Appliances which are no longer needed must be disposed of in a professional and appropriate way, in accordance with the current local regulations and laws.



When disposing of the appliance, ensure that the refrigerant circuit is not damaged to prevent uncontrolled escape of the refrigerant it contains (data on type plate) and oil.

- Disable the appliance.
- Pull out the mains plug.
- Cut through the connection cable.

WARNING

Danger of suffocation due to packaging material and plastic film! Do not allow children to play with packaging material. Take the packaging material to an official collection point.

Range of appliance use

The appliance is suitable solely for cooling food in a domestic environment or similar. This includes, for example, use

- in staff kitchenettes, bed and breakfast establishments,
- by guests in cottages, hotels, motels and other forms of accommodation,
- in catering and similar services in the wholesale trade.

Use the appliance solely as is customary within a domestic environment. All other types of use are inadmissible. The appliance is not suitable for storing and cooling medicines, blood plasma, laboratory preparations or similar substances and products covered by the 2007/47/EC Medical Devices Directive. Any misuse of the appliance may result in damage to or spoilage of stored goods. Furthermore, the appliance is not suitable for operation in potentially explosive atmospheres.

Description of the appliance

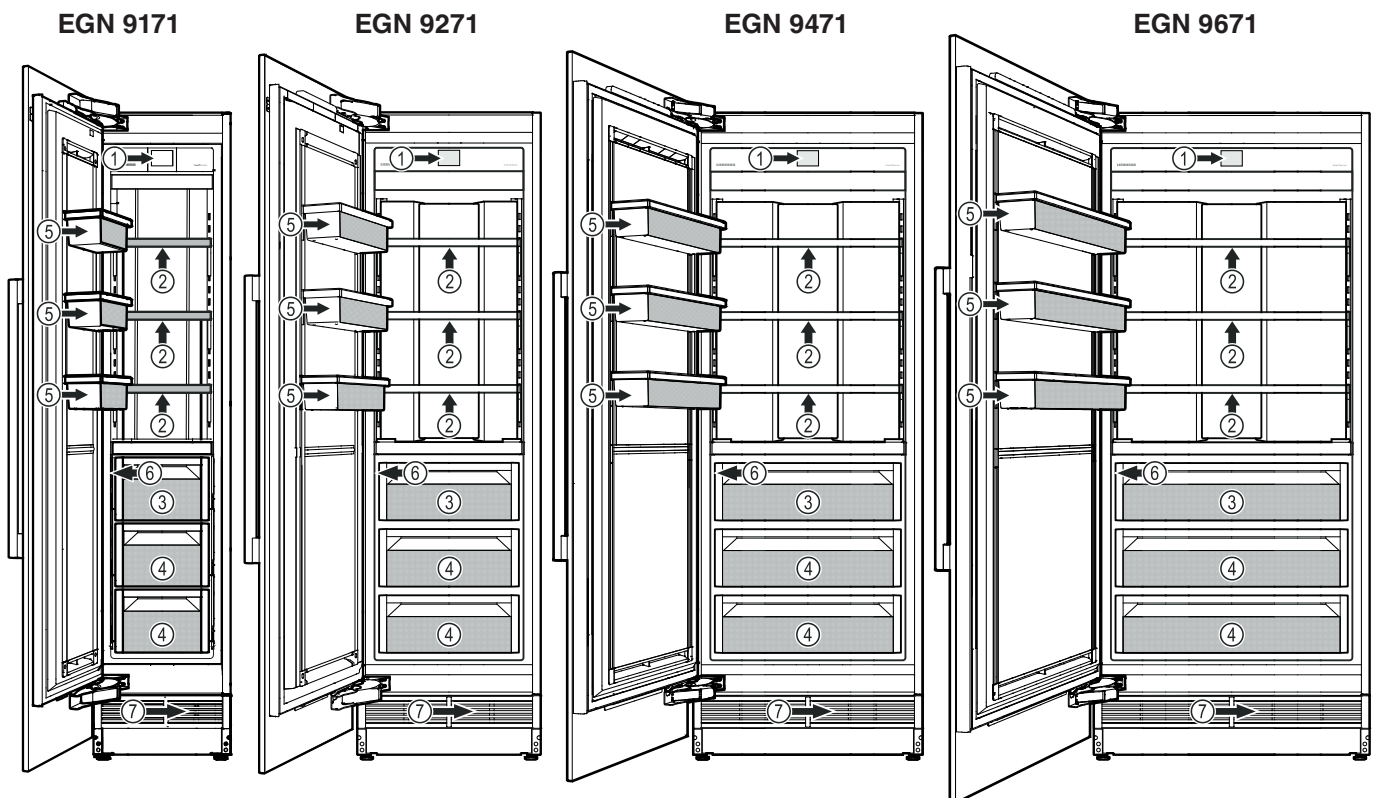

- (5) Adjustable door rack
EGN 91.. (max. 15 kg)
EGN 92.. (max. 20 kg)
EGN 94.. (max. 25 kg)
EGN 96.. (max. 30 kg)

- (6) Type plate (behind the drawer on the left-hand side)
(7) Water filter (behind the ventilation grille)

- (1) Control panel
(2) Adjustable shelves (max. 20 kg)
(3) IceMaker (in the interior of the drawer)
(4) Freezer drawer

Switching the appliance on

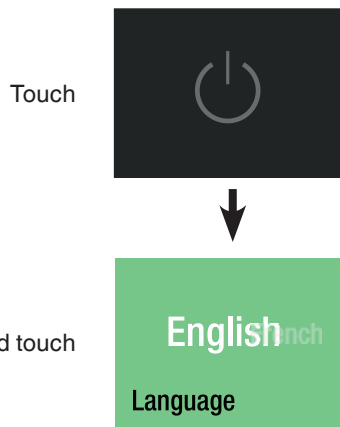

Available languages:

- German
- Portuguese (Brazil)
- French
- Spanish
- Italian
- English (GB)
- English (US)
- Chinese
- Russian

Slide to the desired temperature unit and touch

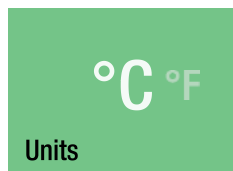

Touch to confirm or slide to the right to change the previous settings again.

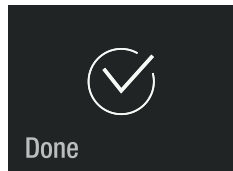

Control panel

Three different actions to operate the control panel.

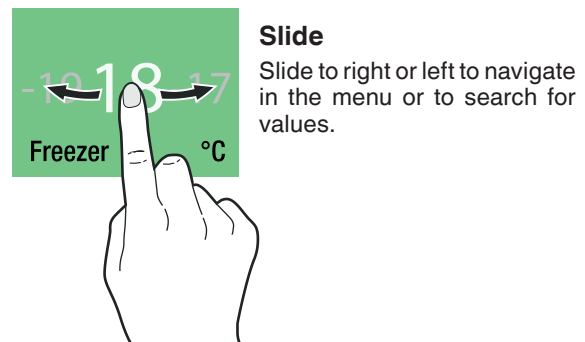
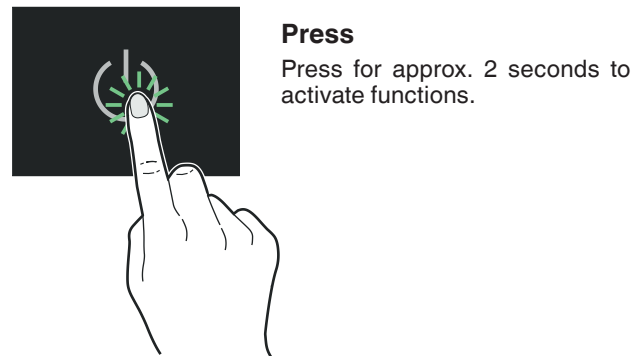
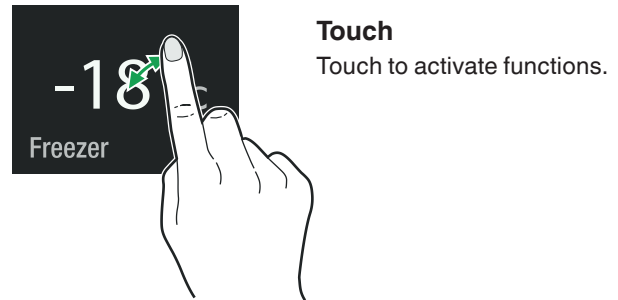

Changing language and temperature unit

For future changes of language and temperature unit, the appliance must be switched off and on again (customer settings will not be deleted).

Setting the temperature

Standard setting is -18°C.

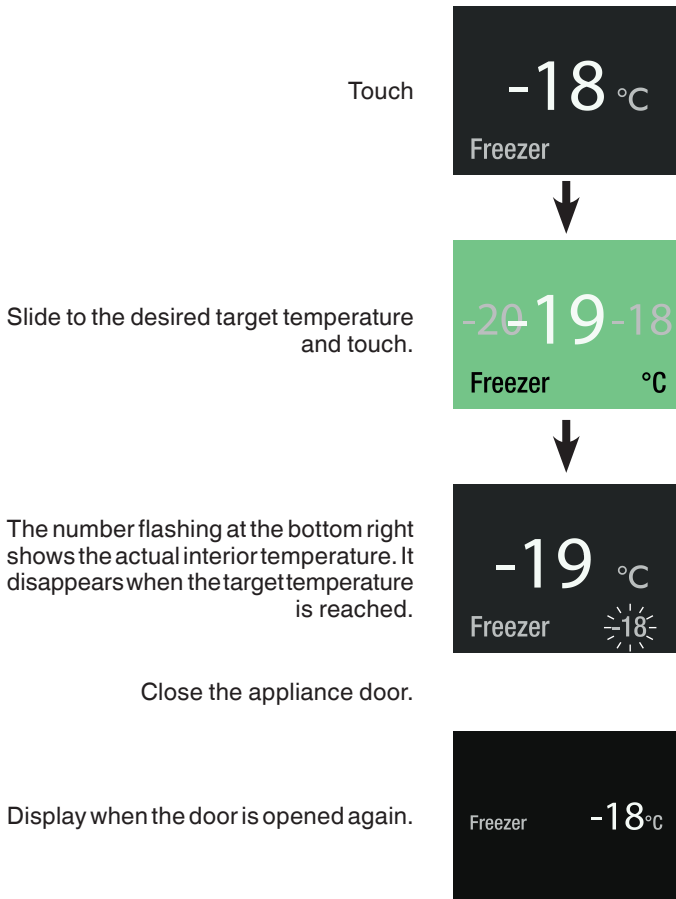

The temperature display flashes if the actual interior temperature is different to the target temperature. It stops flashing when the target temperature is reached.

The temperature can be set at between -14°C and -27°C.

Main menu

Navigation through the main menu. The following functions are available.

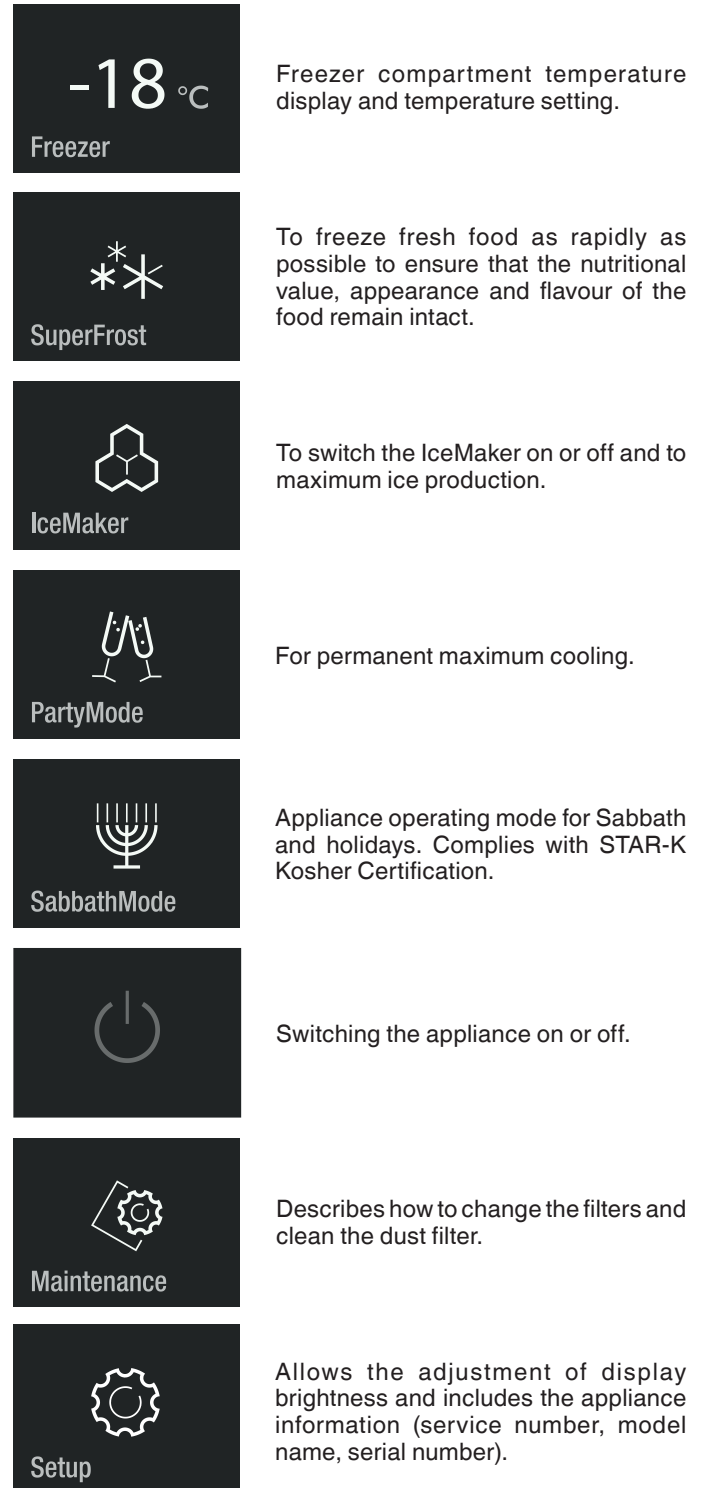

Notes on freezing

- Always store identical food items together.
- Pack food which you are freezing yourself in quantities appropriate to your household. To ensure that the food freezes right through, the following quantities should not be exceeded per package:
 - fruit, vegetables: up to 1 kg,
 - meat: up to 2.5 kg.
- Pack frozen food in standard freezer bags or reuseable plastic, metal or aluminium containers.
- Do not allow fresh food which is to be frozen to come into contact with food already frozen. Always keep packs dry in order to avoid them sticking together.
- Always write the date and contents on the pack and do not exceed the stated storage time for the food.
- Do not freeze bottles and cans which contain carbonated drinks as they might burst.
- Only take out as much food as is immediately required for thawing. Use food which has been thawed in prepared meals as quickly as possible.

Frozen food can be thawed in the following ways:

- in a fan oven
- in a microwave oven
- at room temperature
- in the refrigerator

SuperFrost

Fresh food should be frozen completely and as rapidly as possible. This is provided by the SuperFrost feature and ensures that the nutritional value, appearance and flavor of the food remains intact.

The maximum amount of food in kg which can be frozen in 24 hours is shown on the type plate (**Freezing capacity**).

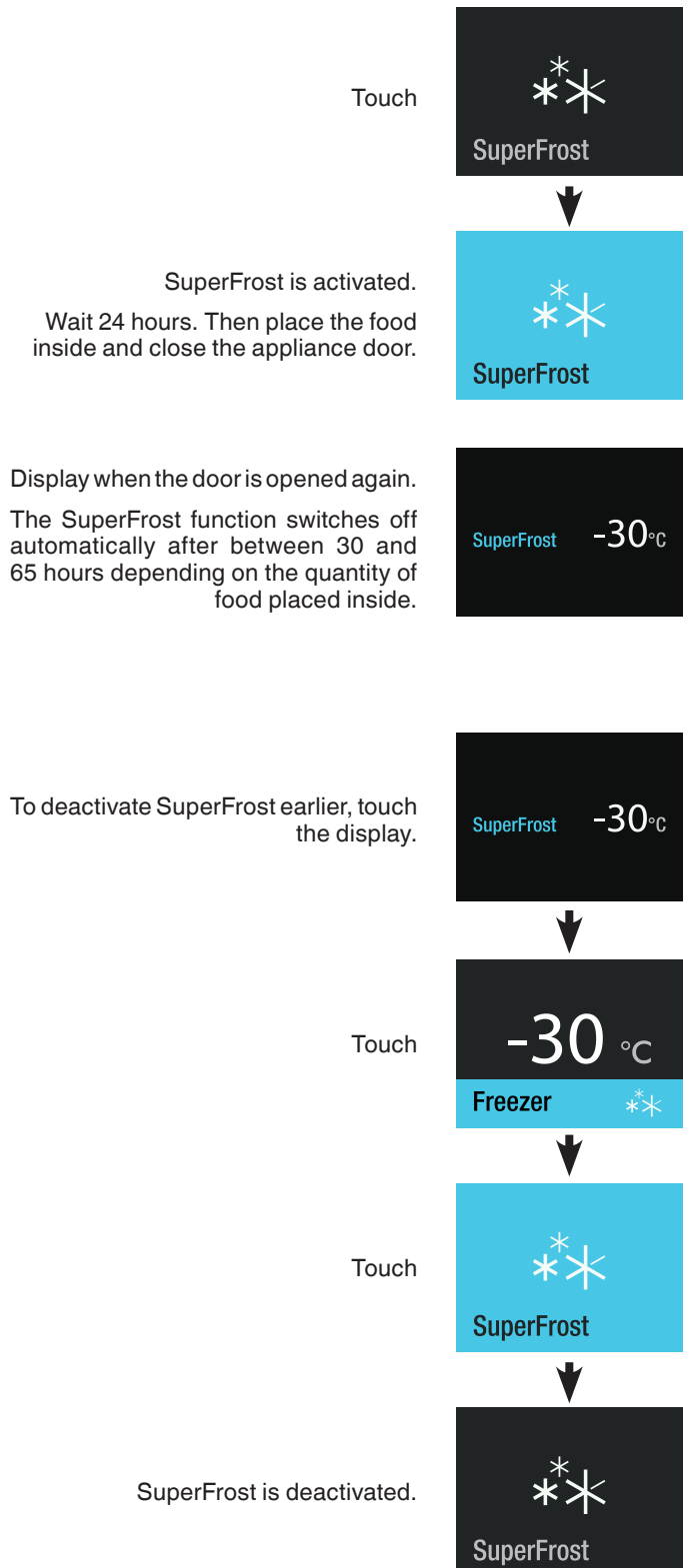

Switching the IceMaker on

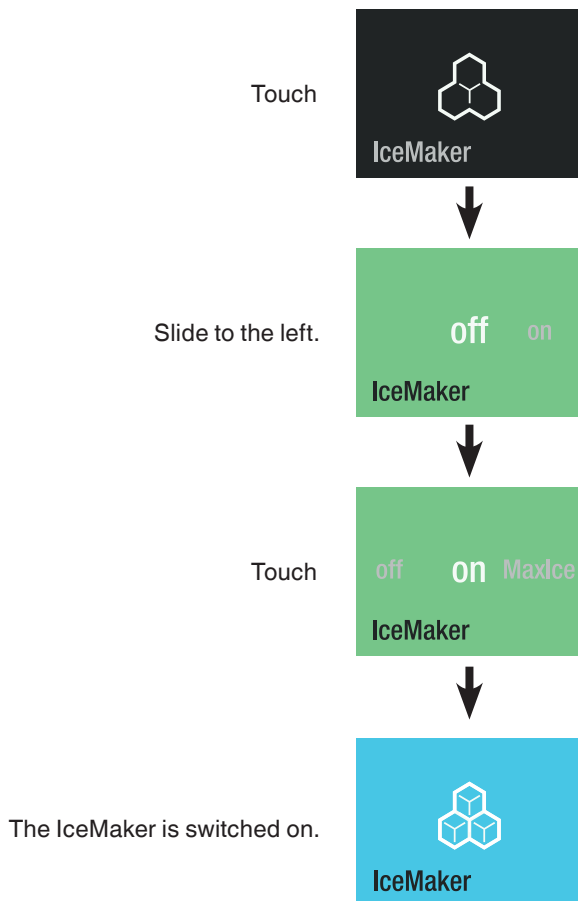

The production capacity is 100 - 120 ice cubes in 24 hours at a temperature of -18°C inside the freezer compartment.

Safety instructions and warnings for the IceMaker

- The IceMaker is designed exclusively to make ice cubes in quantities needed by a household.
- All repairs and work on the IceMaker may only be done by customer service personnel or other appropriately trained personnel.
- **Do not consume or use the first three batches of ice. This applies both to using the appliance for the first time and also using it after it has not been used for a long period of time.**
- **The manufacturer cannot accept liability for damage caused by equipment or water lines between the solenoid valve and the water supply.**

IceMaker description

The IceMaker is in the top drawer of the appliance.

The ice cubes fall out of the IceMaker into the drawer.

When the ice reaches a certain level in the drawer, the appliance stops producing ice automatically.

After you start the IceMaker for the first time, it may take up to 24 hours before the first ice cubes are ready.

IMPORTANT

The first three batches of ice must not be consumed or used.

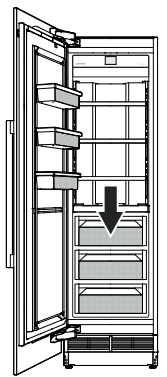

Switching the IceMaker to maximum ice production

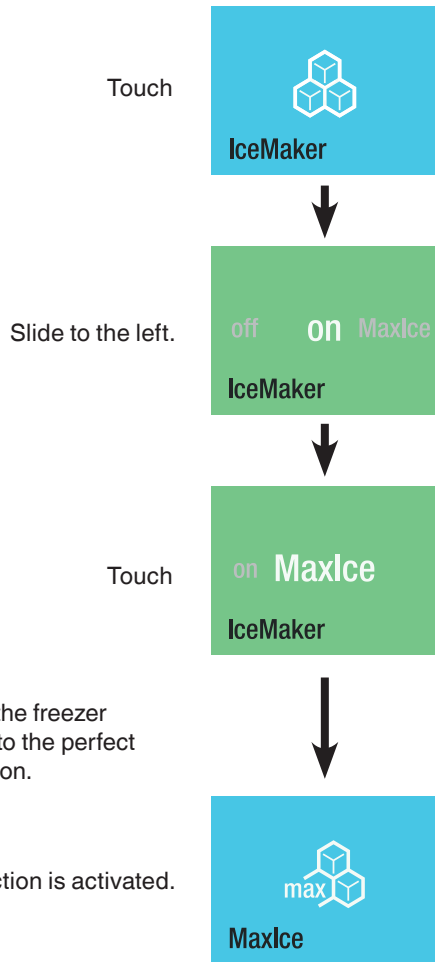

Touch

Slide to the left.

Touch

Note
The temperature in the freezer compartment is set to the perfect level for ice production.

The MaxIce function is activated.

Note
Maximum ice production is switched off after 36 hours.

The production capacity is approx. 150 ice cubes in 24 hours.

Be aware that this increases the energy consumption slightly.

Switching the IceMaker off

Note

Additional steps required to decommission the appliance or for a lengthy absence.

- Switch off the water supply.
- Wait for 24 hours or until the water alarm appears.
- Disable the IceMaker.

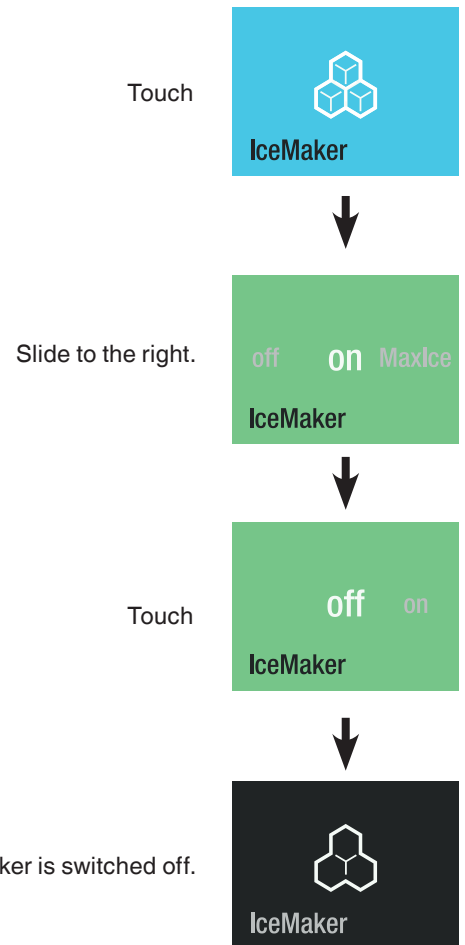

Touch

Slide to the right.

Touch

The IceMaker is switched off.

SabbathMode

When SabbathMode is active, some electronic functions are switched off to comply with STAR-K Kosher Certification.

- The lighting remains off.
- There is no door alarm.
- There is no temperature alarm.
- Defrost cycles are independent of the number of times and length of door openings.
- The appliance will return to SabbathMode after a power failure.

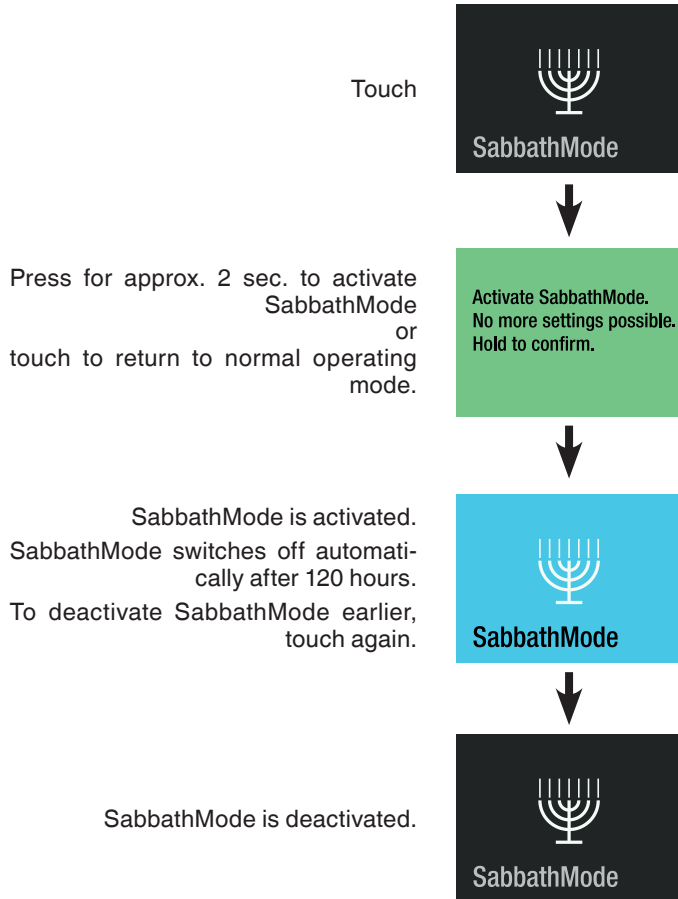

PartyMode

When a large quantity of ice cubes is needed or the spontaneous chilling of beverages is planned: activate PartyMode one day before. Beverages should not be stored in the freezer for more than one hour.

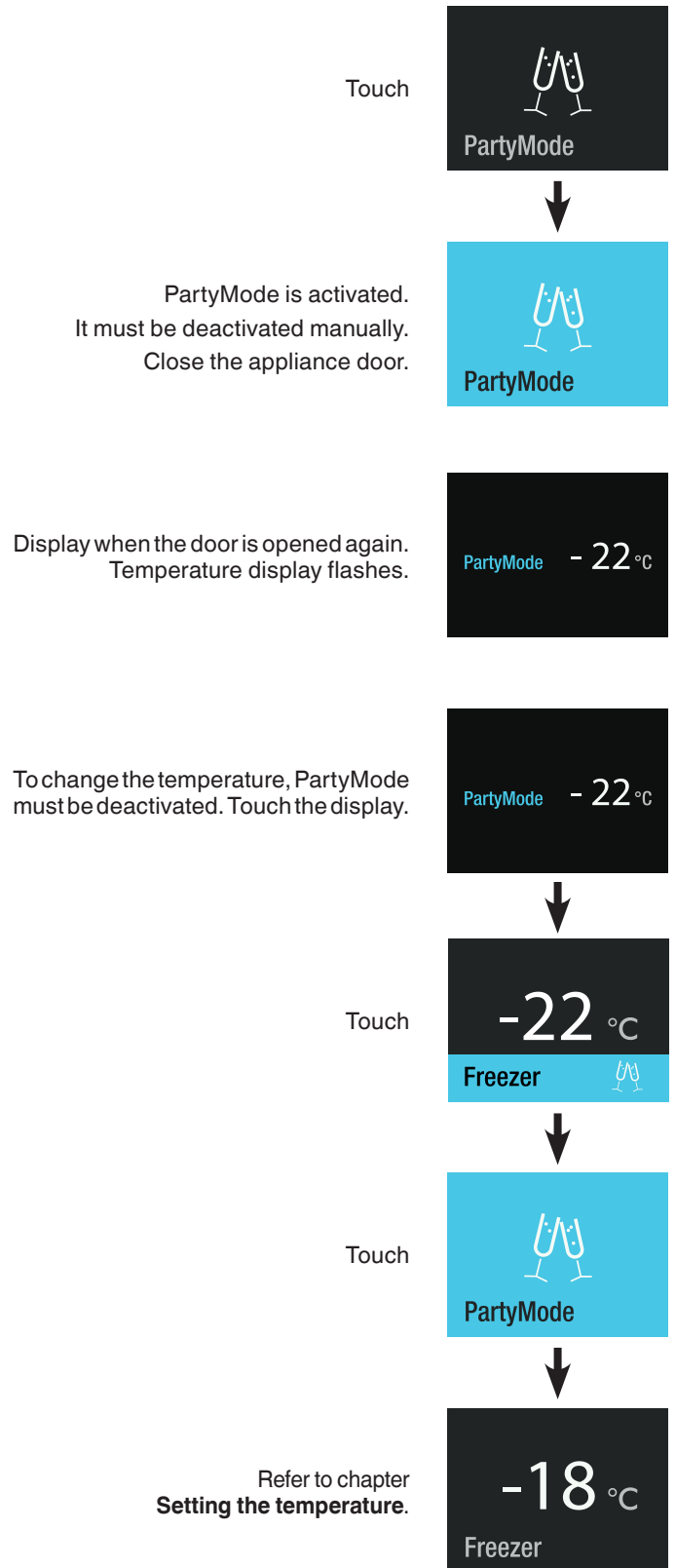

Maintenance message

In regular intervals of operation of the appliance, the maintenance message comes on (6 months). The water filter needs to be changed. The dust filter needs to be cleaned.

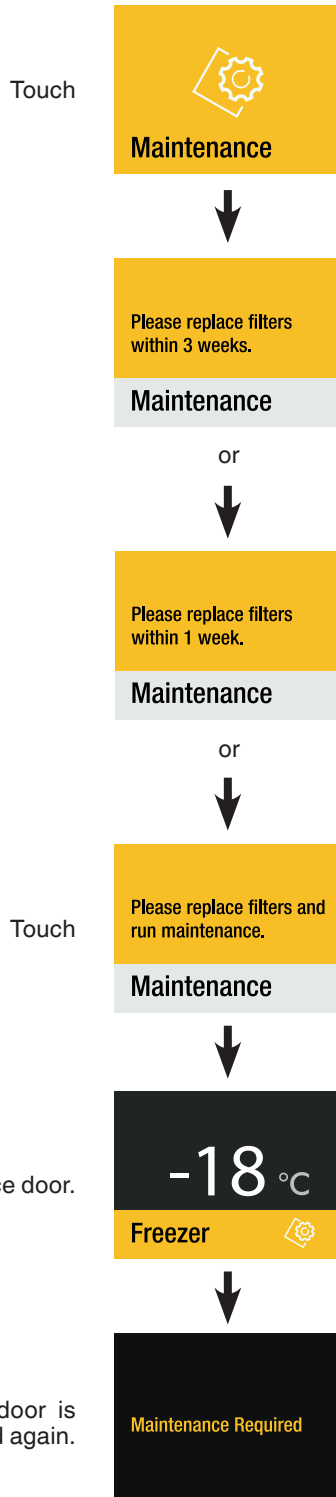

Touch

Touch

Close the appliance door.

Display when the appliance door is opened again.

Obtain the water filter from your dealer and complete the maintenance procedure.

Switching the appliance off

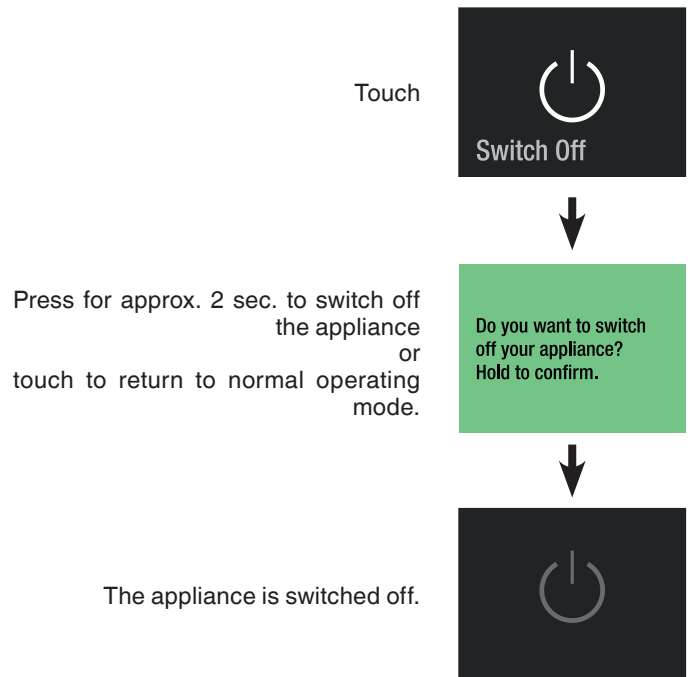

Touch

Press for approx. 2 sec. to switch off the appliance or touch to return to normal operating mode.

The appliance is switched off.

Setup menu

Includes the adjustment for display brightness, language, units, activation of the SmartDeviceBox and the appliance information.

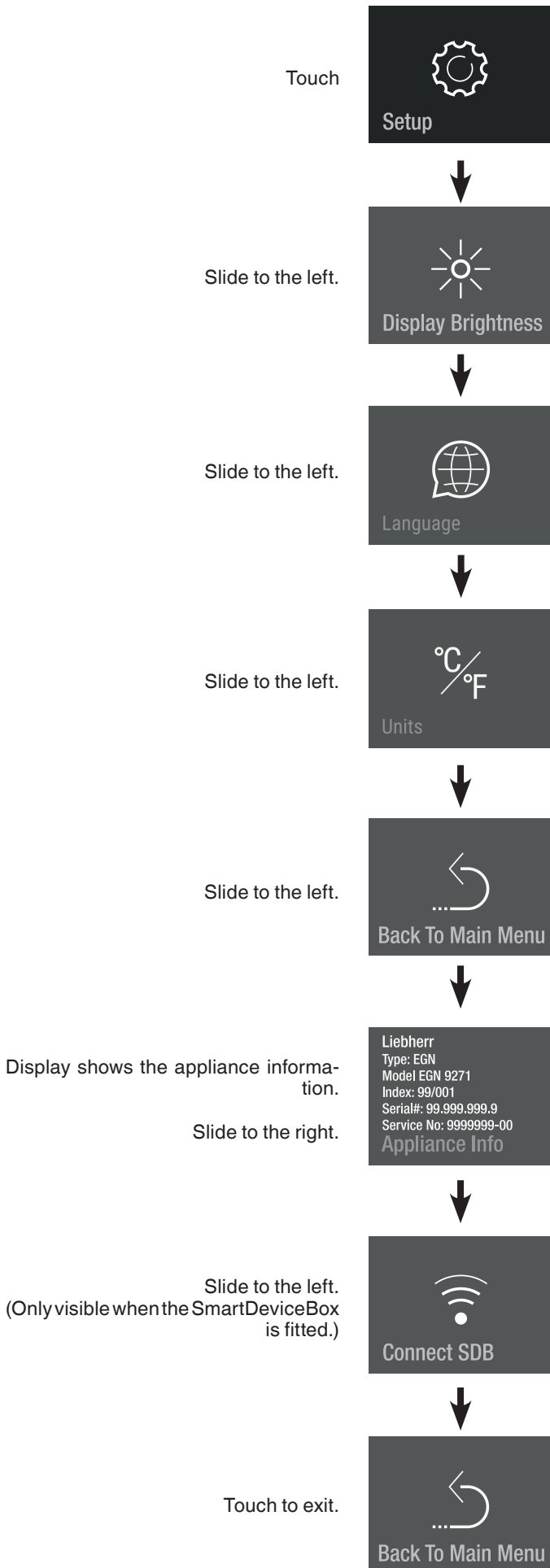

Maintenance confirmation

Note

Remove ice cubes from the IceMaker before starting maintenance.

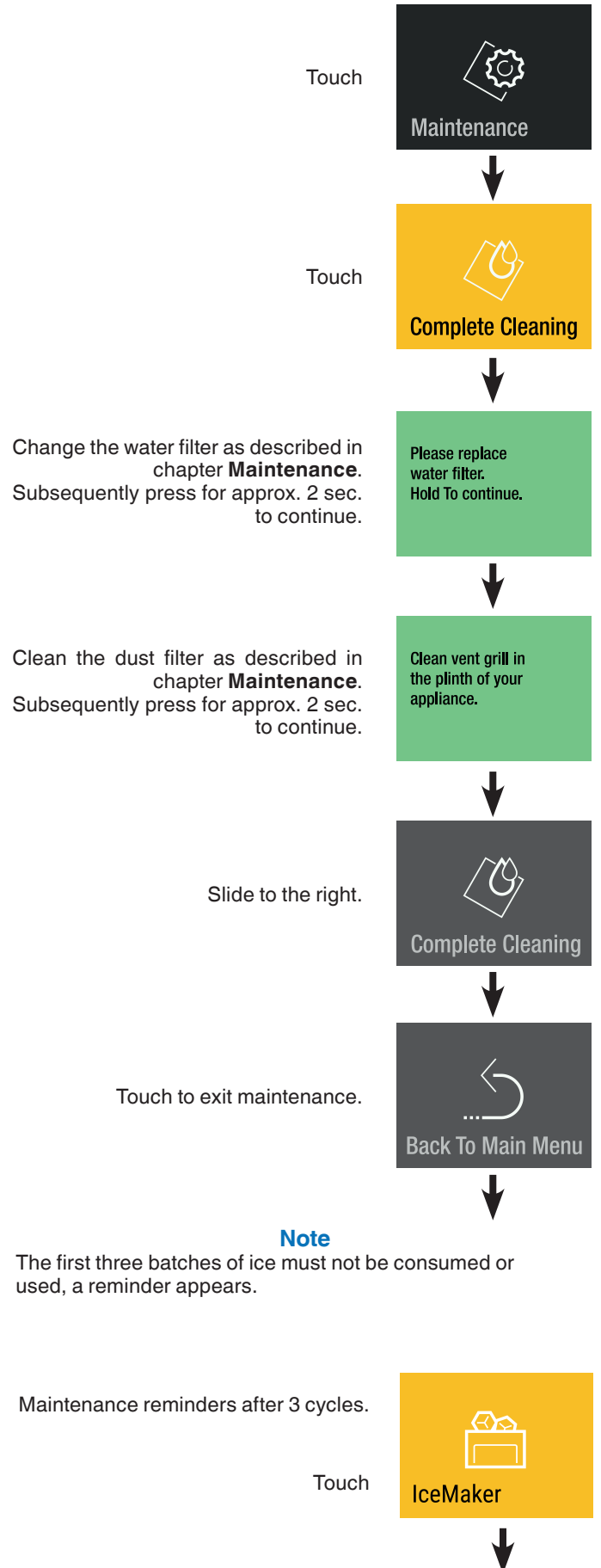

Language

Touch

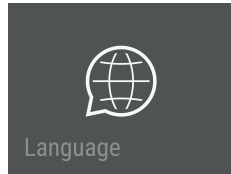

Slide to your language and touch



Available languages:

- German
- Portuguese (Brazil)
- French
- Spanish
- Italian
- English (GB)
- English (US)
- Chinese
- Russian

Slide twice to the left.

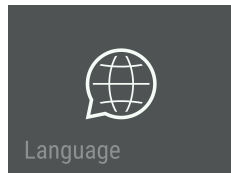

Touch to exit.

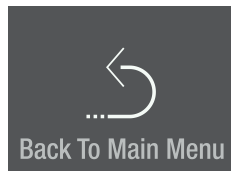

Display brightness

Touch

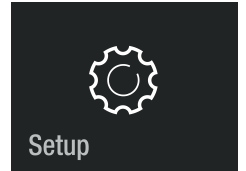

Touch



100% = maximum brightness.
25% = lowest brightness.
Slide to the desired value and touch.



Touch to exit.

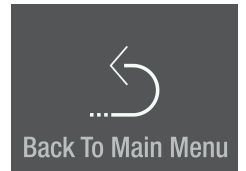

SmartDeviceBox (not supplied in all countries)

The appliance is ready for integration into a smart home system and for extended services.

You will find more information about availability and prerequisites and the individual options on the website smartdevice.liebherr.com.

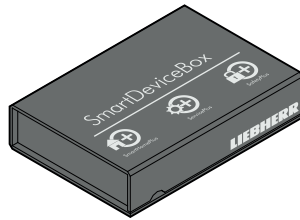

Download the "SmartDevice" app to your mobile device.

Start the app on your mobile device and follow the instructions.

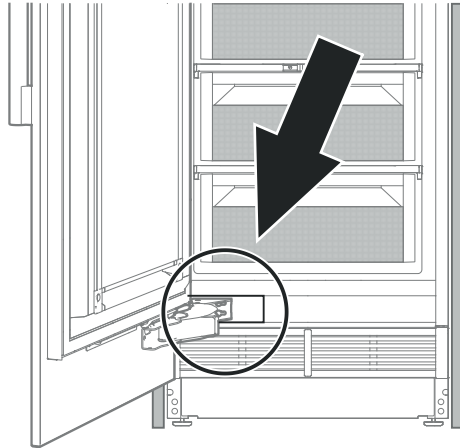

SmartDevice functions are not available in all countries.

Units

Touch

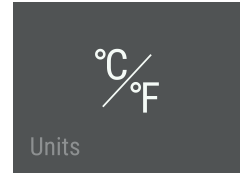

Slide to the desired temperature unit and touch

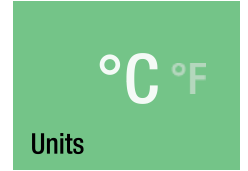

Slide to the left.

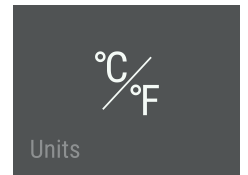

Touch to exit.

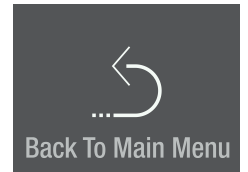

Please remove and dispose of ice cubes from the drawer.

Touch

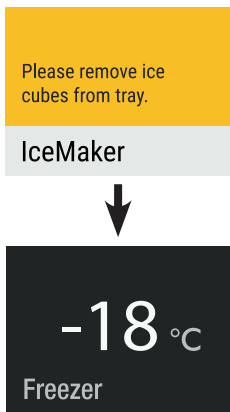

Description of the SmartDevice display

SmartDeviceBox is inserted.

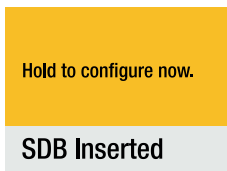

Display to start the WLAN connection.

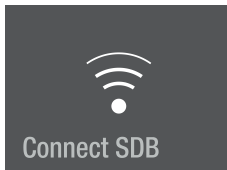

The symbol flashes.

Connection to WLAN is in progress.



The router credentials are displayed.

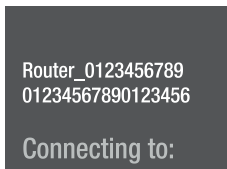

Appliance is connected to WLAN.



Alarm messages

Door open alarm

Door has been left open for longer than 180 seconds.

Action
Close the appliance door.

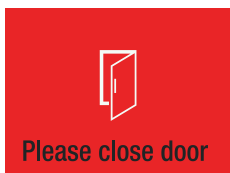

Temperature alarm

Touch



The interior temperature was too high.

Touch



This message informs you of any router or Internet problems.

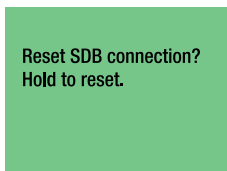

Touch

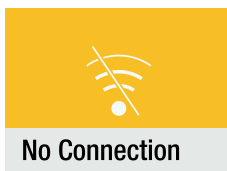

Action
Check the quality of the stored food.

The alarm display disappears as soon as the set temperature is reached.

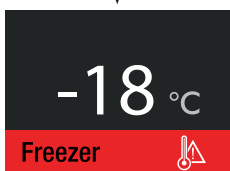

Electronic fault alarm

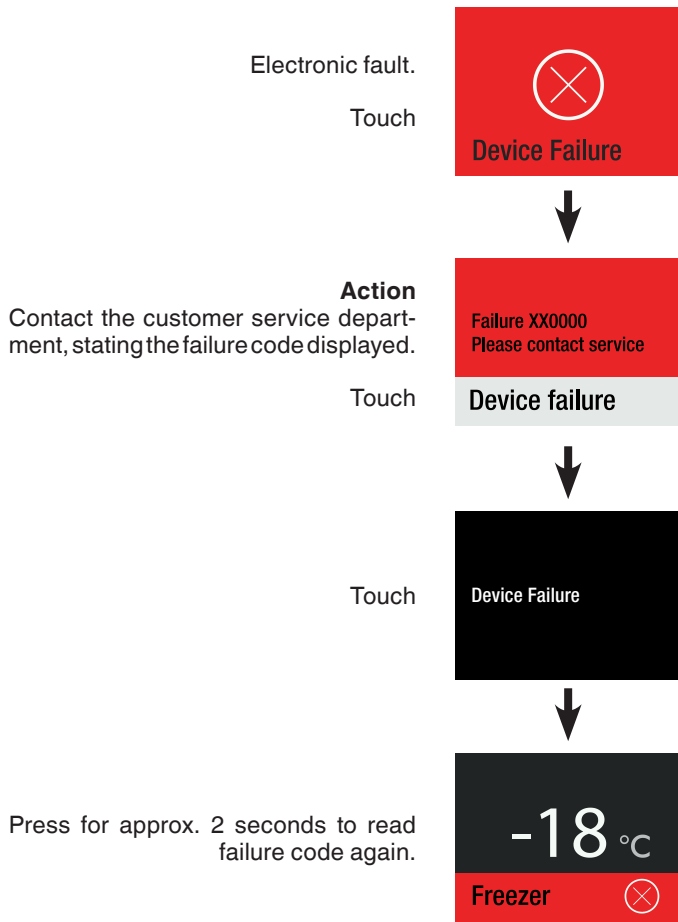

Water alarm

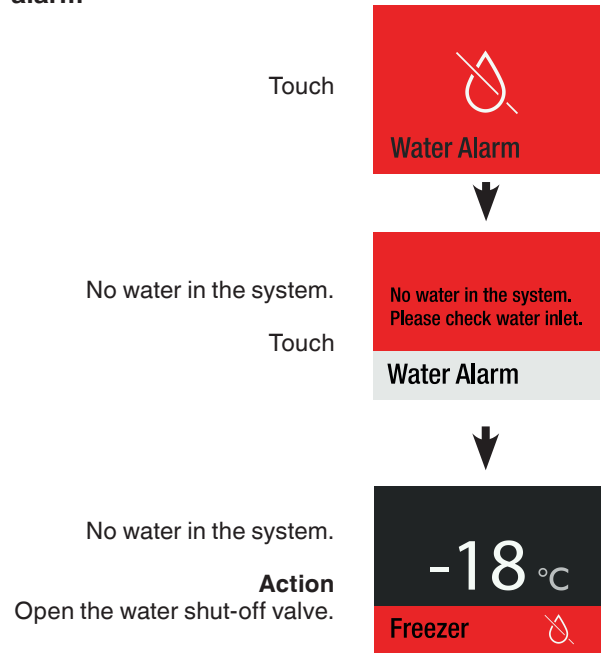

Power alarm

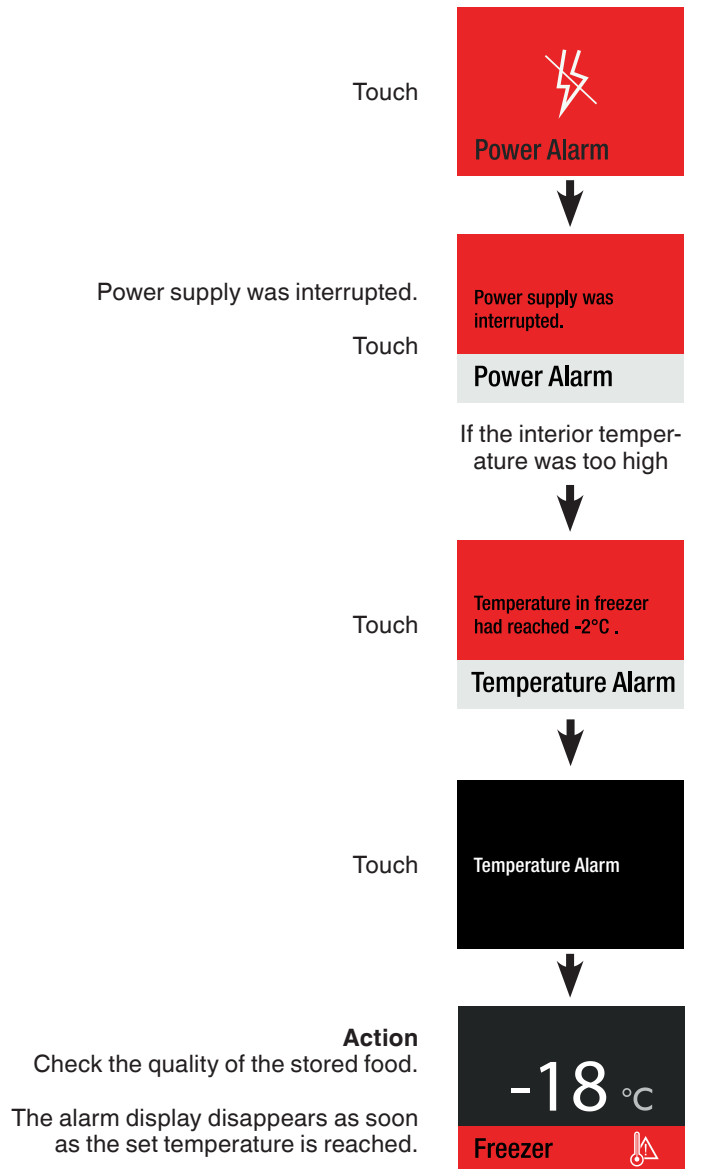

Connection failure

Touch

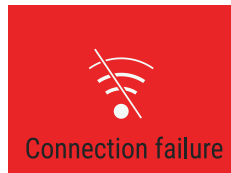

Action

Contact the customer service department, stating the failure code displayed.

Failure XX0000
Please contact service.

Touch

Connection failure



The connection is disabled.
There is no need to move any items to another appliance.

-18 °C

Freezer

The menu will continue to show the "Connection failure" error until it has been rectified by the customer service team.



IceMaker alarm

Touch



Action

Contact the customer service department, stating the failure code displayed.

Failure XX0000
Please contact service.
IceMaker is off

Touch

IceMaker failure



The IceMaker is disabled.
There is no need to move any items to another appliance.

-18 °C

Freezer

The menu will continue to show the "IceMaker failure" error until it has been rectified by the customer service team.



Interior light

The interior light is located on the left and right in the freezer compartment. It turns on when the appliance door is opened.

The light intensity of the LED light corresponds to laser class 1/1M.

IMPORTANT

The light cover may only be removed by customer service staff.

CAUTION!

Risk of eye damage.

If the cover is removed, do not look directly at the light through optical lenses from a close distance.

Lighting	
Class ¹	Light source
This product contains a light source that meets energy efficiency rating G	LED
¹ The appliance may contain light sources with different energy efficiency classes. The lowest energy efficiency class is indicated.	

Equipment

You can position the shelves and door racks at different heights as required.

CAUTION!

Risk of injury and damage.

Do not attempt to adjust a shelf or door rack with food on it.

Only adjust an empty shelf or door rack.

Repositioning the shelves

Removing

Lift the shelf up and remove.

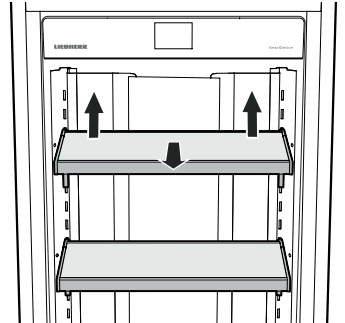

Installing

Insert the hooks of the shelf into the openings of the clip-in strip at the desired height and push down.

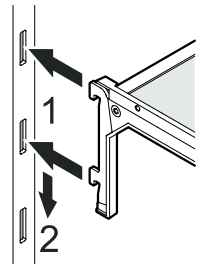

Repositioning the door racks

Removing

Lift the rack up and remove.

Installing

Insert the hooks of the rack into the openings of the clip-in strip at the desired height and push down.

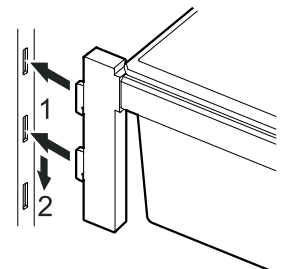
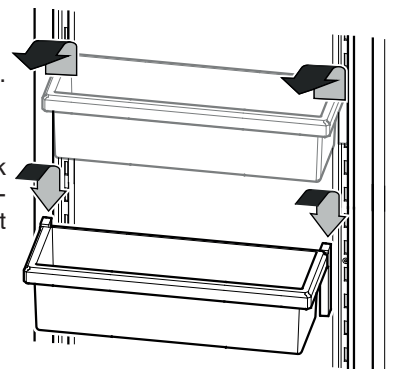

- Install the drawers.
- Extend the pull-out rails as far as they will go. Place the drawer on the rails and slide it right in.

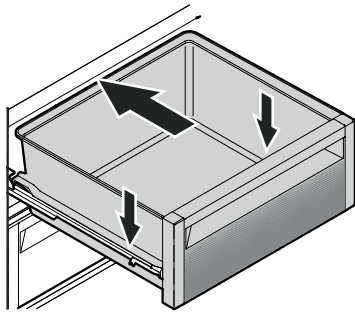

- Install all equipment parts and replace the food in the appliance. Refer to chapter **Equipment**.
- Switch the appliance on.

Cleaning

WARNING!

- To prevent possible injury due to an electric shock, be sure to disconnect the mains cable or switch off the fuse before cleaning the appliance.
- To avoid injury or damage, do not use steam cleaning equipment to clean the appliance.
- To avoid short-circuits, ensure no cleaning water penetrates into the electrical components when cleaning the appliance. Do not use a sponge or cloth that is overly wet.

- Remove all food from the appliance and store in a cool place temporarily.
- Remove the glass shelves and door racks. Refer to chapter **Equipment**.

- Remove the drawers. →
Pull the drawer straight out, grip at the back and lift out.

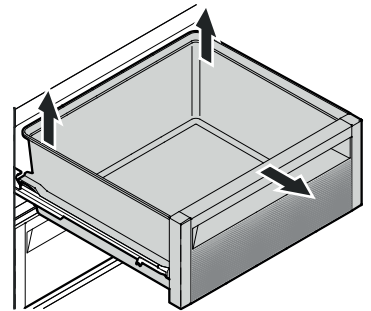

- Clean the inside of the appliance and equipment parts with lukewarm water and a little detergent.

IMPORTANT

Do not use abrasive sponges or scourers, do not use concentrated cleaning agents and never use cleaning agents containing sand, chloride or acid or chemical solvents.

- Clean the pull-out rails with a slightly dampened cloth only. →

IMPORTANT

No cleaning water must be allowed to get into the pull-out rail guides.

- Dry all parts well with a cloth.
- Do not damage or remove the type plate on the inside of the appliance. It is very important for servicing purposes.

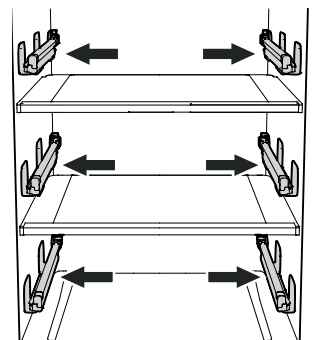

Maintenance menu

Maintenance can be carried out independently of the specified regular intervals. The maintenance menu includes the following steps.

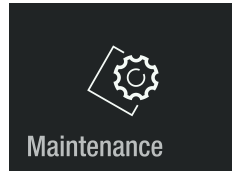

Complete cleaning
For complete maintenance of the appliance.

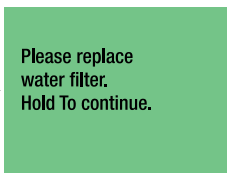
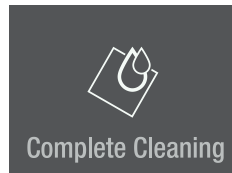

New water filter
To reset maintenance timer.

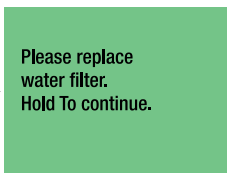
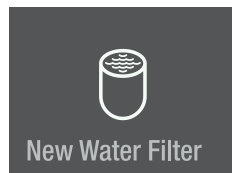

To return to the main menu.

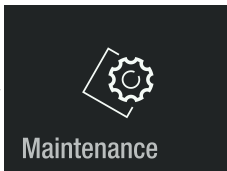
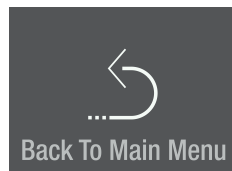

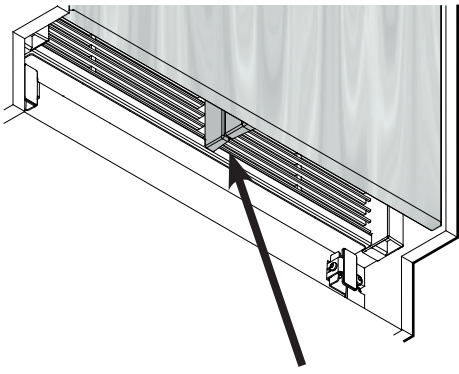

Check that there is no gap between the appliance air divider and the door air divider.

IMPORTANT

There will be a gap if the ventilation grille is fitted incorrectly.

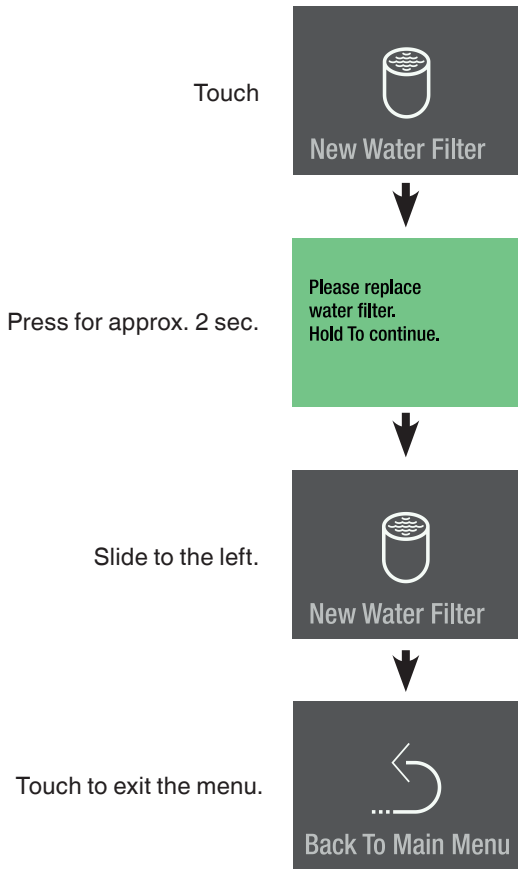

Maintenance

New water filter

The inserted water filter absorbs deposits in the water and reduces the taste of chlorine.

Note

It is not required to switch off the water supply when removing or inserting the filter.

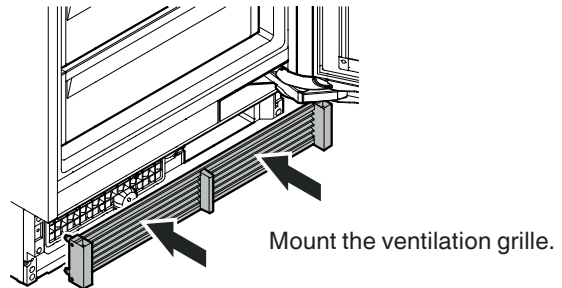
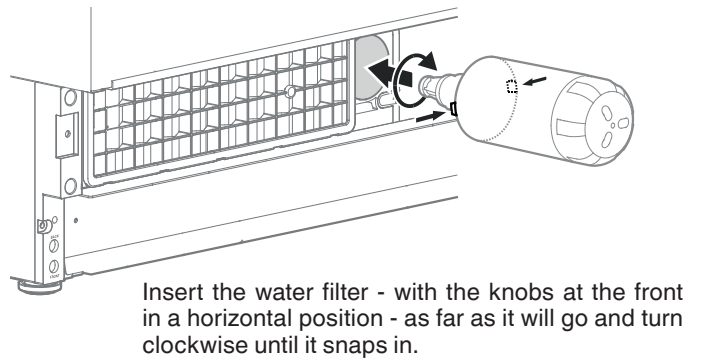
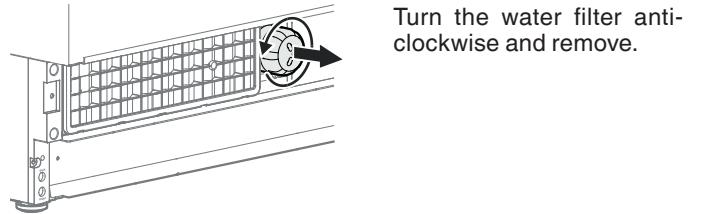
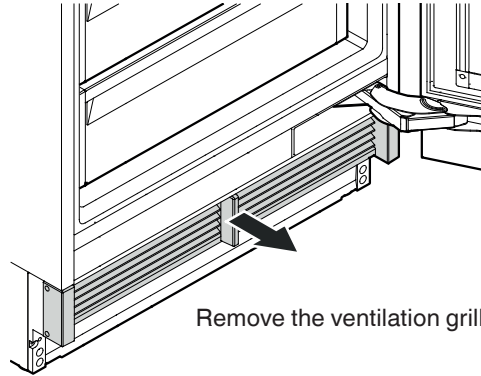

Additional functions

Water pressure adjustment
 Activating the defrost function manually
 Reset to factory settings
 DemoMode

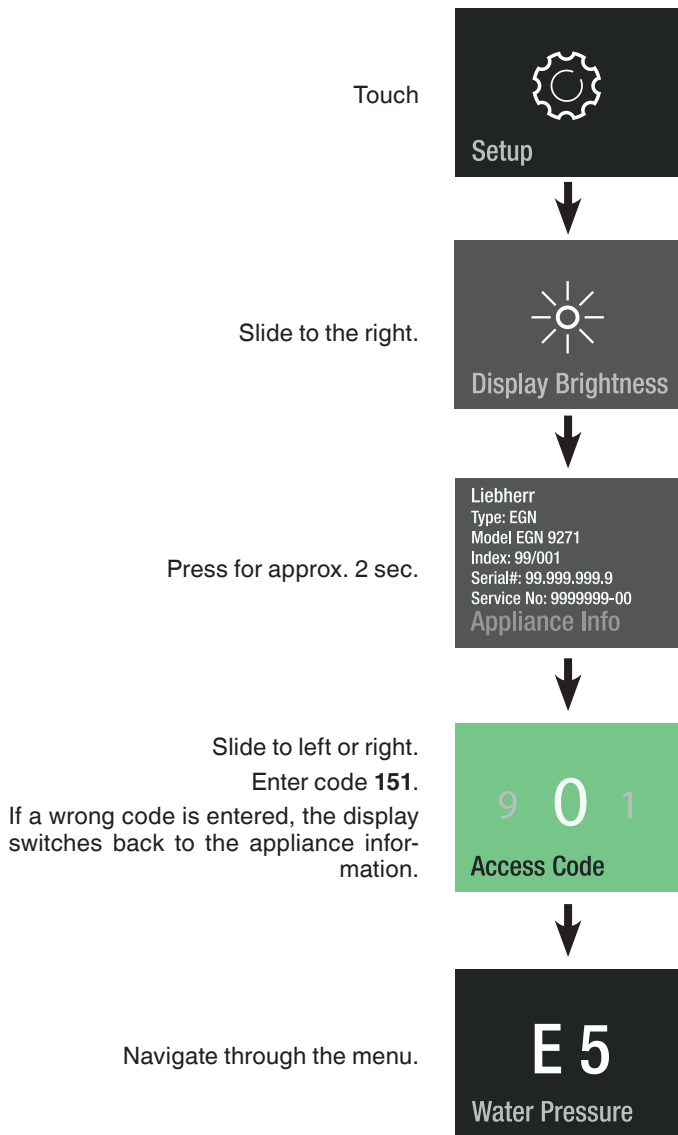

Cleaning the dust filter

Clean the dust filter in the plinth area at least at the indicated maintenance intervals.

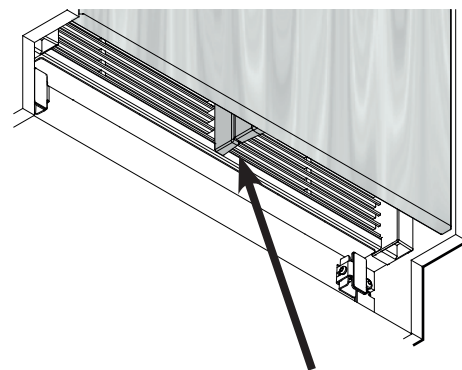
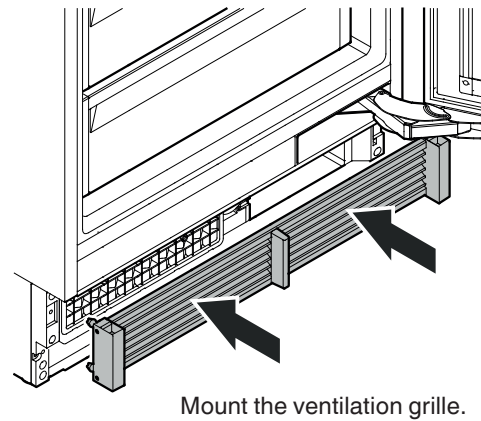
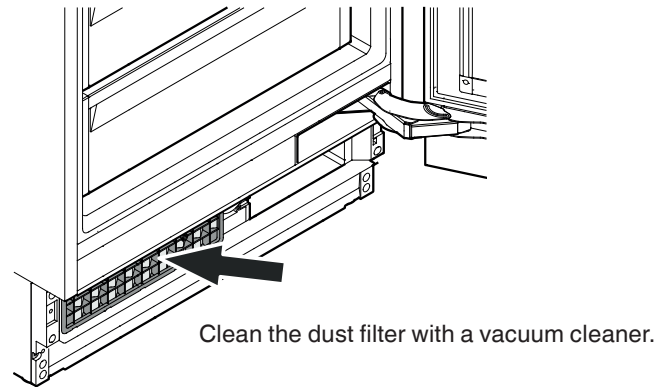
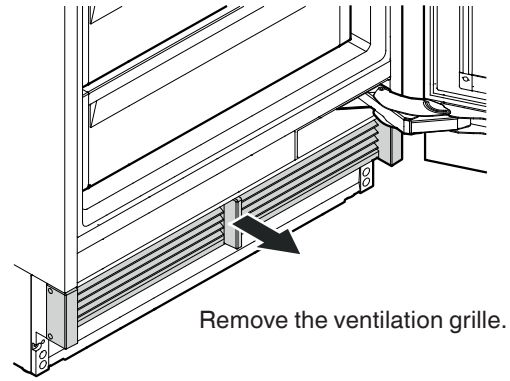

Check that there is no gap between the appliance air divider and the door air divider.

IMPORTANT

There will be a gap if the ventilation grille is fitted incorrectly.

Manual defrost

The appliance defrosts automatically. The defrost function can be activated manually for service applications.

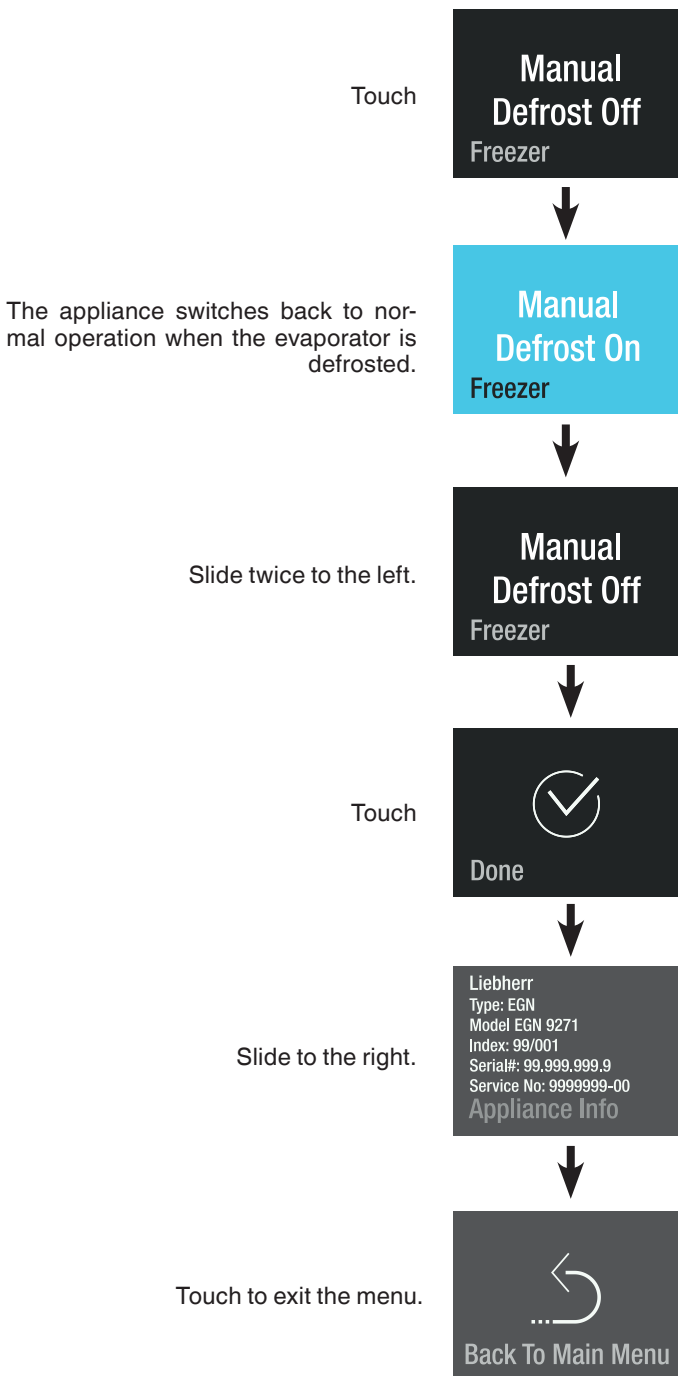

Water pressure

If the ice cubes produced by the IceMaker are too small (the first few batches are always smaller), the inflowing water quantity can be adjusted.

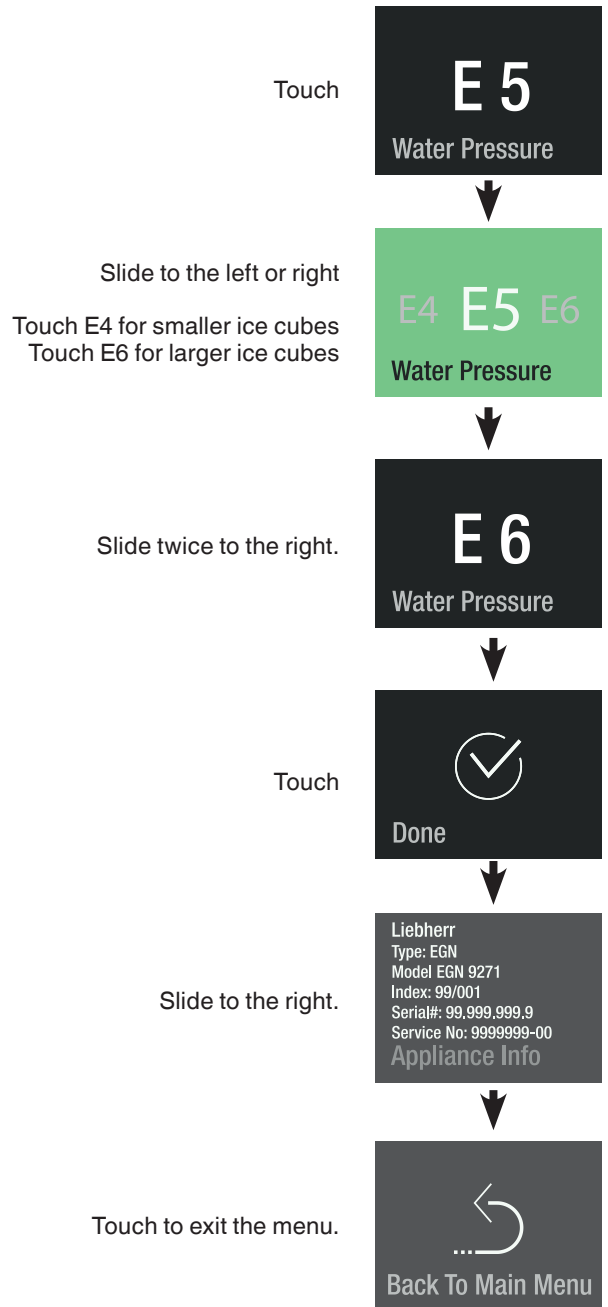

IMPORTANT

Do not increase for more than one step. If the adjusted value is too high, the ice cube tray of the ice maker could overflow.

Check the ice cube size within the next days. If the ice cubes are still smaller than desired, increase the value for one step again.

DemoMode

DemoMode can be activated for presenting the appliance at exhibitions or in salesrooms as if it were in normal operating mode.

Activating DemoMode

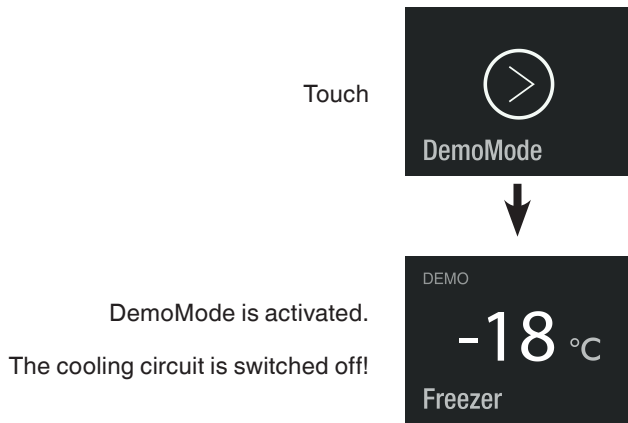

Reset

The electronic control system can be reset to factory settings using this function.

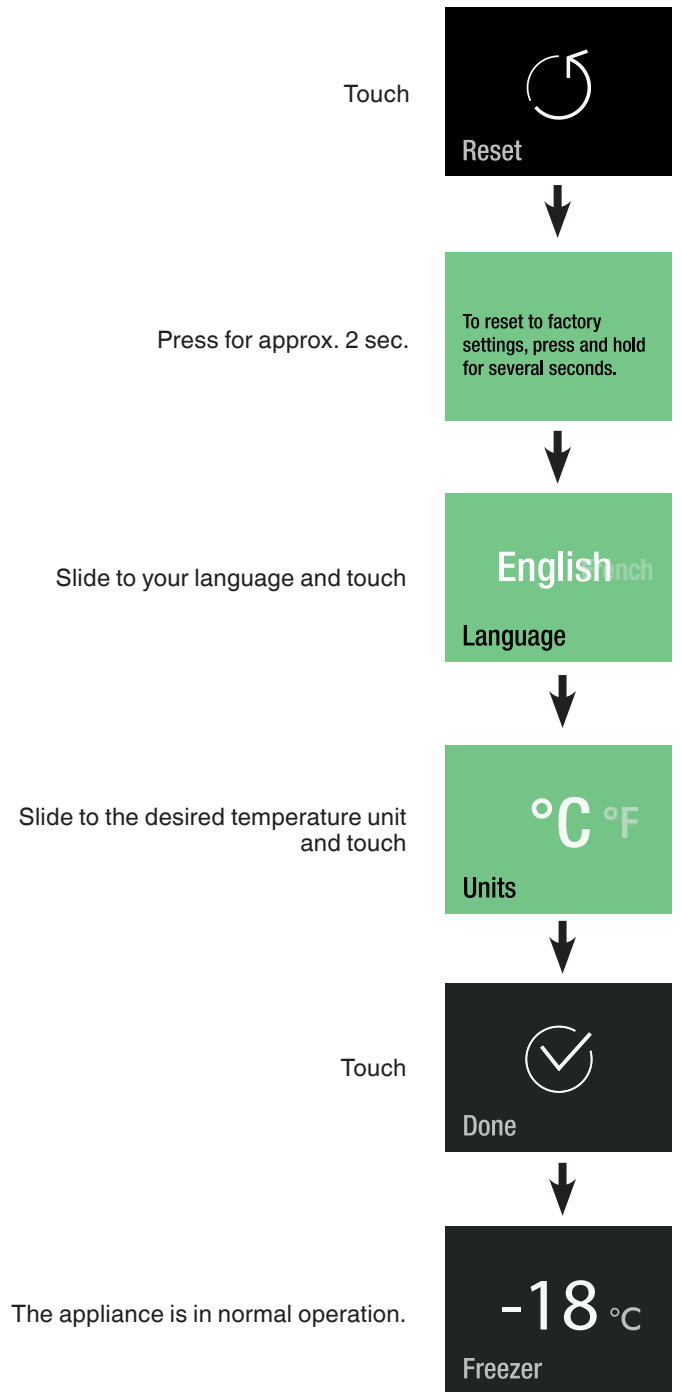

Saving energy

- Always ensure good ventilation. Do not cover ventilation openings or grille.
- Always keep fan slits clear.
- Do not place the appliance in direct sunlight or near cookers, radiators and similar sources of heat.
- The energy consumption depends on the installation conditions, e.g. the ambient temperature.
- Keep the time the appliance is open to a minimum.
- Store food logically.
- Ensure that all food is well packed and covered for storage. This will prevent frost from forming.
- First cool warm food to room temperature before storing it.
- Defrost frozen food in the refrigerator.
- Empty and switch off the refrigerator compartment for longer holiday periods.

Malfunctions

You may be able to rectify the following faults by checking the possible causes yourself:

Appliance does not function:

- Is the appliance switched on?
- Is the plug correctly fitted in the mains socket?
- Is the fuse intact?

Loud running noise:

- Is the appliance set up firmly on the floor?
- Does the appliance cause nearby items of furniture or objects to vibrate? Please note that noises caused by the refrigerant circuit cannot be avoided.

The temperature is not low enough:

- Is the temperature setting correct (see "Setting the temperature")?
- Have excessive amounts of fresh food been placed in the appliance?
- Does the separately installed thermometer show the correct reading?
- Is the ventilation system working properly?
- Is the appliance set up too close to a heat source?

If none of the above causes apply and you cannot rectify the fault yourself, contact the nearest customer service department stating the type designation (1), service number (2) and appliance number (3) as indicated on the type plate.

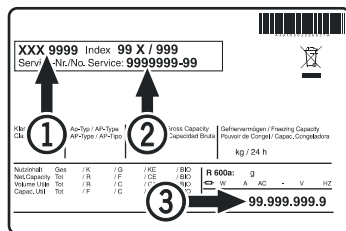

The position of the type plate is shown in the section entitled **Description of the appliance**.

Shutting your appliance down

If your appliance is to be shut down for any length of time, disable the IceMaker as described in "Switching the IceMaker off", switch it off and disconnect the plug or switch off or unscrew the fuse. Clean the appliance and leave the door open in order to prevent unpleasant smells.

The appliance complies with the relevant safety regulations and EU Directives 2014/30/EU and 2014/35/EU.

Deactivating DemoMode

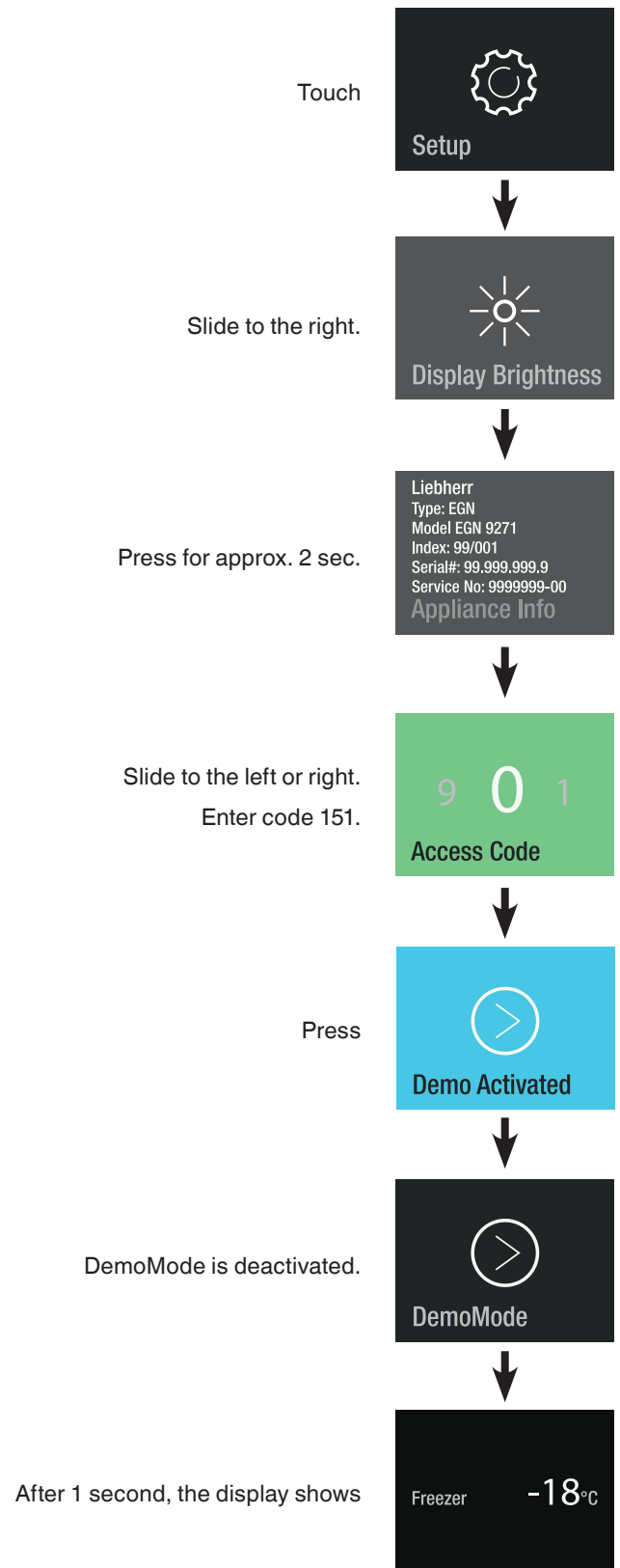

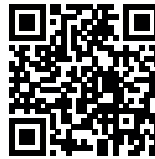

Liebherr Hausgeräte Lienz GmbH
Dr.-Hans-Liebherr-Strasse 1
A-9900 Lienz
Österreich
www.liebherr.com