

# Operating instructions

Multi-temperature wine cabinet

Read the operating instructions before switching on for the first time

Page 12

EN

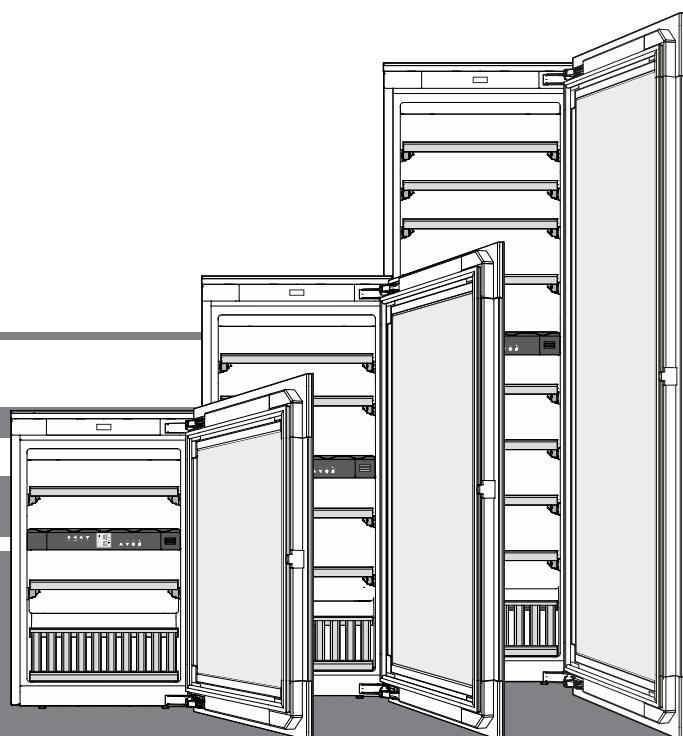

**7085 667-01**



EWTgb/gw 1683 / 2383 / 3583



## Content

Priority of warnings.....	12
Safety instructions and warnings .....	12
Symbols on the appliance .....	13
EPREL database .....	13
Range of appliance use.....	14
Description of the appliance.....	14
Disposal notes.....	14
Climate rating .....	15
Setting up .....	15
Electrical connection.....	15
Door opening mechanism .....	15
Operating and control elements .....	16
Switching the appliance on and off .....	16
Setting the temperature.....	16
Fan .....	16
Door open alarm.....	16
Temperature alarm.....	17
Set-up mode.....	17
Interior light.....	18
Labels .....	18
Air exchange with activated charcoal filter .....	18
Removing and inserting the wooden shelves.....	19
Storage diagram.....	19
Storage diagram	
Presentation shelf.....	20
Cleaning .....	21
Malfunctions.....	21
Shutting your appliance down.....	21

## Priority of warnings



 <b>DANGER</b>	identifies a situation involving direct danger which, if not obviated, may result in death or severe bodily injury.
 <b>WARNING</b>	identifies a dangerous situation which, if not obviated, may result in death or severe bodily injury.
 <b>CAUTION</b>	identifies a dangerous situation which, if not obviated, may result in minor or medium bodily injury.
<b>NOTICE</b>	identifies a dangerous situation which, if not obviated, may result in damage to property.
<b>Note</b>	identifies useful information and tips.

## Safety instructions and warnings

- **WARNING:** do not seal ventilation openings on the appliance housing or enclosure.
- **WARNING:** only use the mechanical devices or other aids recommended by the manufacturer to help speed up the defrosting process.
- **WARNING:** do not damage the refrigerant circuit.
- **WARNING:** do not use any electrical devices in the refrigerator compartment which do not comply with the design recommended by the manufacturer.
- **WARNING:** the mains cable must not be damaged while installing the appliance.
- **WARNING:** multi-sockets or distributor strips and other electronic devices (such as halogen transformers) must not be positioned and operated at the rear of appliances.
- **WARNING:** danger of injury through electric shock. There are live parts under the cover. Only have the interior LED light replaced or repaired by customer service staff or trained personnel.
- **WARNING:** risk of injury from the LED lamp. The light intensity of the LED light complies with laser class RG 2. If the cover is defective, do not look directly at the light through optical lenses from close distance. This may damage your eyes.
- **WARNING:** this appliance must be secured as described in the operating instructions (Installation instructions) to rule out any potential risks due to its instability.
- This appliance may be used by children aged 8 and over and by people with reduced physical, sensory or mental abilities or a lack of experience and expertise if they are supervised or have been instructed on the safe use of the appliance and have understood the risks associated with it. Children must not be allowed to play with the appliance. Cleaning and user maintenance must not be carried out by children without supervision. Children aged 3 or over and 8 or younger may load and unload the refrigerator/freezer.

- Do not store any explosive substances, such as aerosol containers with flammable propellant gas, inside the appliance.
- To prevent injury and damage to property, the appliance should only be installed by two people.
- After unpacking it, check the appliance for signs of damage. Contact the supplier if it is damaged. Do not connect the appliance to the mains power supply.
- Avoid prolonged skin contact with cold surfaces (e.g. chilled/frozen products). If necessary, take safety action (e.g. gloves).
- All repairs and work on the appliance may only be carried out by customer service personnel or other trained personnel. The same applies to changing the mains power cable.
- Only carry out repair and other work on the appliance when the mains plug has visibly been disconnected.
- Only install, connect and dispose of the appliance as described in these operating instructions.
- In the event of a fault, pull out the plug or switch off the fuse.
- When disconnecting the appliance from the mains, pull on the plug. Do not pull on the cable.
- If you have a lockable appliance, do not keep the key near the appliance or within reach of children.
- The appliance is designed for use in enclosed areas. Do not operate the appliance outdoors or in areas where it is exposed to splash water or damp conditions.
- Do not use the interior LED light to light the room. The interior LED light is only designed to illuminate the interior of the appliance.
- Do not allow naked flames or ignition sources to enter the appliance.
- Alcoholic drinks or other vessels containing alcohol should be sealed tightly for storage.

## Symbols on the appliance

	The symbol can be located on the compressor. It refers to the oil in the compressor and indicates the following danger: swallowing or inhaling can be fatal. This is only relevant for recycling. There is no danger in normal operation.
	Warning about inflammable substances.
	A sticker to this effect may be applied to the rear of the appliance. It refers to the foampadded panels in the door and/or the housing. This is only relevant for recycling. Do not remove the sticker.

## EPREL database

As from 1 March 2021, information about energy labelling and ecodesign requirements will be available in the European product database (EPREL). You can access the product database using the following link: <https://eprel.ec.europa.eu/>. You will be asked to enter the model identifier. You will find the model identifier on the type plate.

## Range of appliance use

The appliance is suitable solely for storing wine in a domestic environment or similar. This includes, for example, use

- in staff kitchenettes, bed and breakfast establishments,
- by guests in cottages, hotels, motels and other forms of accommodation,
- in catering and similar services in the wholesale trade.

Use the appliance solely as is customary within a domestic environment. All other types of use are inadmissible.

The appliance is not suitable for storing and cooling medicines, blood plasma, laboratory preparations or similar substances and products covered by the 2007/47/EC Medical Devices Directive. Any misuse of the appliance may result in damage to or spoilage of stored goods.

Furthermore, the appliance is not suitable for operation in potentially explosive atmospheres.

## Disposal notes

The appliance contains reusable materials and should be disposed of properly - not simply with unsorted household refuse. Appliances which are no longer needed must be disposed of in a professional and appropriate way, in accordance with the current local regulations and laws.



When disposing of the appliance, ensure that the refrigerant circuit is not damaged to prevent uncontrolled escape of the refrigerant it contains (data on type plate) and oil.

- Disable the appliance.
- Pull out the mains plug.
- Cut through the connection cable.

## ⚠ WARNING

**Danger of suffocation due to packing material and plastic film!**

**Do not allow children to play with packaging material.**

**Take the packaging material to an official collection point.**

## Description of the appliance

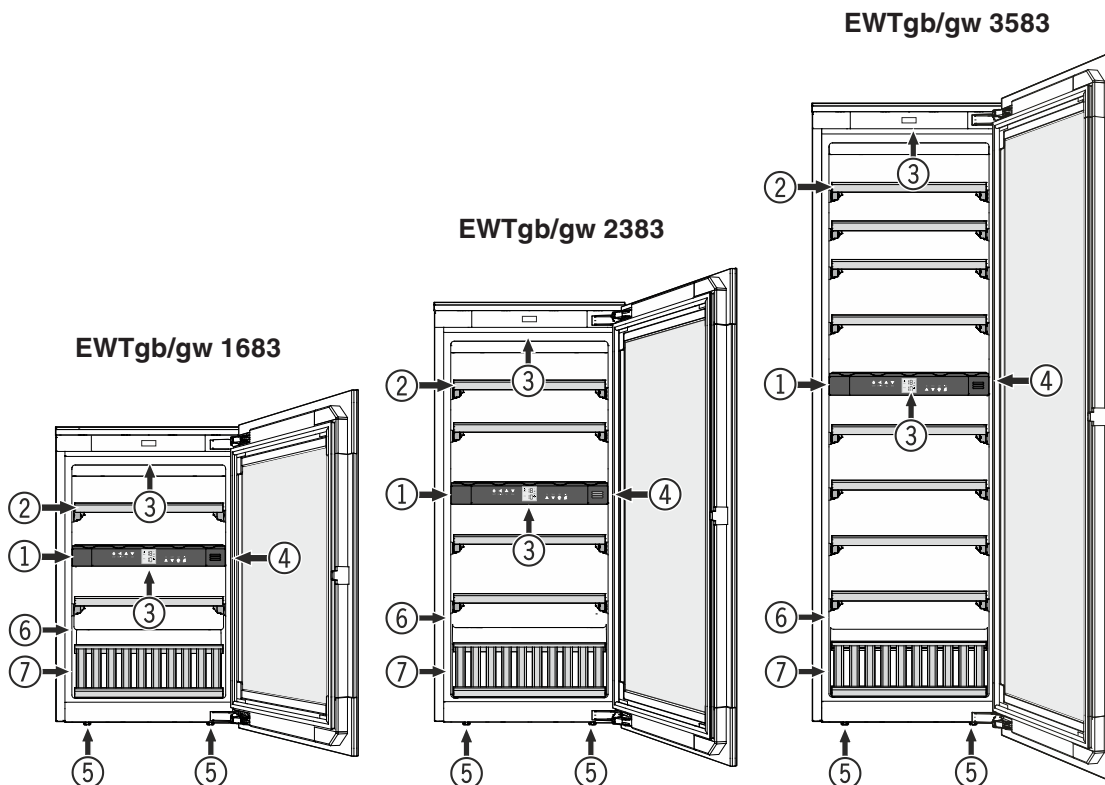

- (1) Operating and control elements
- (2) Pull-out shelves
- (3) Interior light (LED light strip)
- (4) Activated charcoal filter
- (5) Adjustable-height feet
- (6) Type plate
- (7) Presentation shelf



## Climate rating

The climate rating indicates the room temperature at which the appliance may be operated in order to achieve full refrigeration performance.

The climate rating is indicated on the type plate.

The position of the type plate is shown in the section entitled **Description of the appliance**.

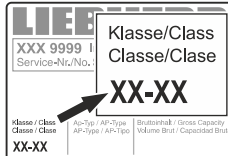

Climate rating	Room temperature
SN	+10°C to +32°C
N	+16°C to +32°C
ST	+16°C to +38°C
T	+16°C to +43°C
SN-ST	+10°C to +38°C
SN-T	+10°C to +43°C

## Do not operate the appliance outside the specified room temperature range.

## Setting up

- Avoid positioning the appliance in direct sunlight or near cookers, radiators and similar sources of heat.
- Standard EN 378 specifies that the room in which you install your appliance must have a volume of 1 m<sup>3</sup> per 8 g of R 600a refrigerant used in the appliance, so as to avoid the formation of inflammable gas/air mixtures in the room where the appliance is located in the event of a leak in the refrigerant circuit. The quantity of refrigerant used in your appliance is indicated on the type plate on the inside of the appliance.

## Electrical connection

Only operate the appliance with **alternating current (AC)**.

The permissible voltage and frequency are indicated on the type plate. The position of the type plate is shown in the section entitled **Description of the appliance**.

The socket must be properly earthed and protected by a fuse.

The tripping current of the fuse must be between 10 A and 16 A.

The socket must not be situated behind the appliance and must be easily accessible.

Do not connect the appliance using an extension cable or extension socket.

Do not use stand-alone inverters (conversion of direct current to alternating/three-phase current) or energy-saving plugs. Risk of damage to the electronic control system!

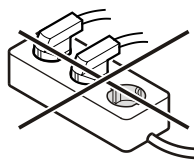

## Door opening mechanism

The appliance is equipped with a door opening mechanism.

### Opening the door

Push the door slightly inwards on the top left-hand side and release again.

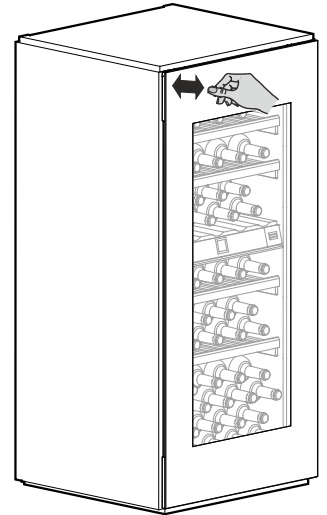

The door is opened approx. 7 cm by the push rod.

The door can then be fully opened.

### Note

The door will close again automatically after approx. 3 seconds if it has not been fully opened.

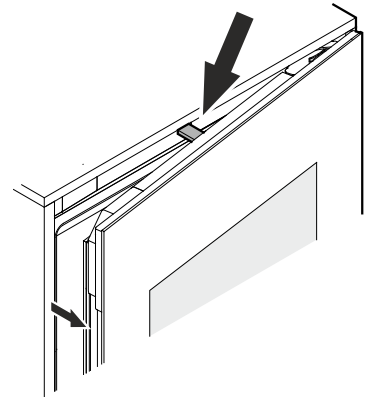

## Important notes

**Do not operate the appliance near magnetic fields or place magnetic objects near the appliance.**

**The door may otherwise open when you do not want it to.**

**Do not block the door or hold on to it while it is opening.**

If the door is blocked or held open during opening, the internal safety coupling will be activated.

**Loud, repeated cracking noises will be heard.**

**Do not push the push rod in or hold on to it during closing.**

If the push rod is blocked during closing, it will no longer be able to reach its initial position.

In the initial position, the push rod is flush with the front of the appliance.

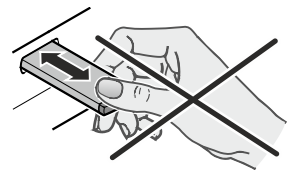

### Setting the push rod back in its initial position

**Disconnect the appliance from the mains, wait for approx. 5 seconds and plug it back in again.**

The push rod returns to its initial position.

## Operating and control elements



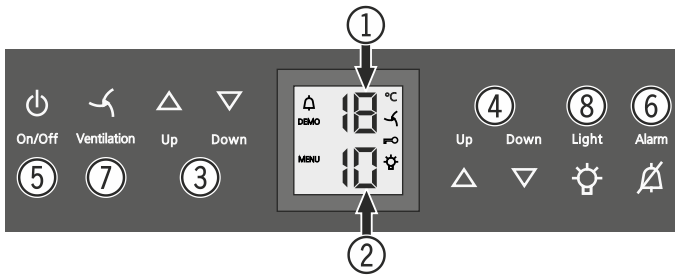

The electronic control panel has the new "touch capacitance technology". Any function can be activated by touching the corresponding icon.

The exact contact point is between the symbol and its label  On/Off



- (1) Upper compartment temperature display
- (2) Lower compartment temperature display
- (3) Upper compartment temperature setting buttons
- (4) Lower compartment temperature setting buttons
- (5) On/Off button (switching the appliance on and off)
- (6) Audible warning On/Off button
- (7) Fan switch
- (8) Interior light On/Off button

### Symbols in the display

-  Alarm (symbol flashes if the temperature inside the appliance is too high or too low)
- DEMO** Demo mode is activated
- MENU** Setup mode is activated (activating the child lock and adjusting the display brightness)
-  The interior fan runs constantly
-  Child lock is activated
-  The interior light is switched on constantly

## Switching the appliance on and off

### Switching the appliance on

Press the **On/Off** button until the temperature display lights up.



On/Off

### Switching the appliance off

Keep the **On/Off** button pressed for approx. 3 seconds so that the temperature display goes out.

## Setting the temperature

The temperature of both compartments can be set separately.

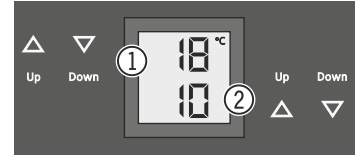

- (1) Upper compartment
- (2) Lower compartment

### Reducing the temperature

Press the **Down** button.

### Increasing the temperature

Press the **Up** button.

- When pressing one of the buttons for the first time, the display will start to flash.
- Pressing this button again enables you to change the temperature setting.
- The electronic control system will switch over automatically about 5 seconds after the last time you pressed the button, and the actual temperature will be displayed.

The temperature can be set at between +5°C and +20°C.

The following drinking temperatures are recommended for the various types of wine.

Red wines: **+14°C to +20°C**

Rosé wines: **+10°C to +12°C**

White wines: **+8°C to +12°C**

Sparkling wines, Prosecco: **+7°C to +9°C**

Champagne: **+5°C to +7°C**

If you are storing wine for long periods of time, it should be stored at a temperature of between +10°C and +12°C.

## Fan

The interior fan ensures a constant and even interior temperature and a suitable climate for wine storage.

The humidity in the appliance can be increased even further by activating the **Ventilation** button. This has a particularly positive effect for long-term storage.



The increased level of humidity prevents the corks from drying out.

## Door open alarm

If the door is left open for more than 60 seconds, the audible warning signal will sound.

If the door must be opened for a lengthy period to place items into the appliance, cancel the audible warning signal by pressing the **Alarm** button.



The alarm switches back to standby when the door is shut.

## Temperature alarm

If the temperatures in the interior are out of the permitted range, the audible warning signal will sound and the temperature display will flash.

- Cancel the audible warning signal by pressing the **Alarm** button.

After a lengthy power failure, the temperature in the interior may have risen to too high a level. After the power supply returns, the fall in temperature can be watched on the display.

The temperature display will stop flashing as soon as the temperature in the interior has reached the set value.

### Temperature alarm after a fault in the appliance

If the appliance develops a fault, the temperature in the interior may rise too high or fall too low. The audible warning signal will sound and the temperature display will flash.

- Cancel the audible warning signal by pressing the **Alarm** button.

If the temperature displayed is too high (warm), first check whether the door is closed correctly.

If the temperature display continues to show a value that is too high or too low after one hour, contact the customer service department.



If **F1, F8, E1, E2, E7** or **E8** appears in the display, the appliance has suffered a fault.



In this case, contact the customer service department.



## Set-up mode



In set-up mode, you can set the child lock and adjust the brightness of the display. The child lock is designed to protect the appliance from being switched off and the temperature setting from being changed accidentally.

### Activating the child lock



Press  for 5 seconds. Display = 



 Display =  |

 Display =  

 Display = 

### Deactivating the child lock



Press  for 5 seconds. Display =  

 Display =  

 Display = 

 Display = 

### Adjusting the display brightness

Press  for 5 seconds. Display = 

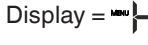

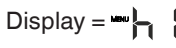
 Display = 

 Display = 

Use buttons **Up** and **Down** to select the desired setting.

- h0** = display lighting off
- h1** = minimum brightness
- h5** = maximum brightness

 Display = 

 Display = 

The adjusted brightness will be activated after one minute.

#### Note

If a button is pressed, the display lights up for one minute at maximum brightness.

When commissioning the appliance, the adjusted brightness will only be active once the set interior temperature of the appliance has been reached.

## Interior light

The interior of the appliance is lit by an LED light strip at the top of each compartment.

The interior light will always switch on when the appliance door is opened. The interior light will go out approx. 5 seconds after the door is closed.

Press the **Light** button if you want the interior light to be on even when the door is closed.



### Note

This function applies to the lighting of both compartments.

Furthermore, the brightness of the lighting can be adjusted.

- Press the **Light** button.
- Press and hold the **Light** button and at the same time press the temperature setting buttons to increase or decrease the brightness.

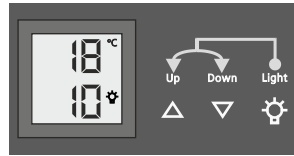

**Note:** The brightness will change in all compartments.

Lighting	
Class <sup>1</sup>	Light source
This product contains a light source that meets energy efficiency rating G	LED
<sup>1</sup> The appliance may contain light sources with different energy efficiency classes. The lowest energy efficiency class is indicated.	

## Labels

The appliance is supplied with one label for each wooden shelf.

Use these to label the type of wine stored on each shelf.

Additional labels can be obtained from your dealer.

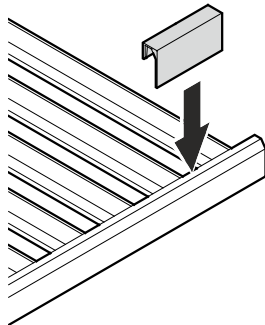

## Air exchange with activated charcoal filter

The way in which wines continue to mature depends on the ambient conditions.

The quality of the air is therefore decisive for preserving the wine.

We recommend that you replace the illustrated filter once a year. Filters can be obtained from your dealer.

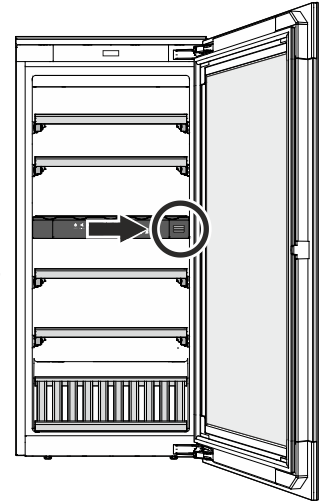

## Changing the filter

- Push the cover in and release it again.

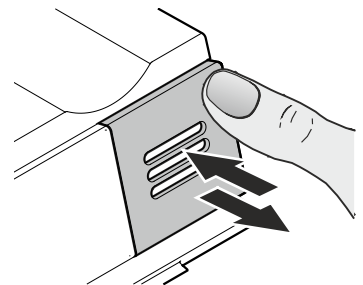

- Pull out the filter.

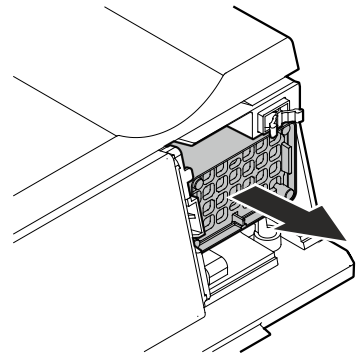

- Insert the filter

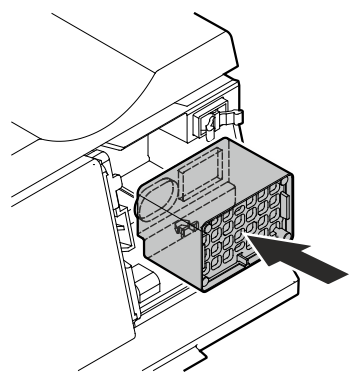

- Insert the cover, push it in as far as it will go and then release it again.  
The cover is automatically locked into place.  
You will hear a click.

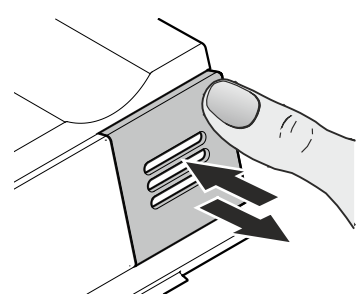

## Removing and inserting the wooden shelves

The wooden shelves can be removed for easier cleaning of the inside of the appliance.

### Removing the wooden shelf

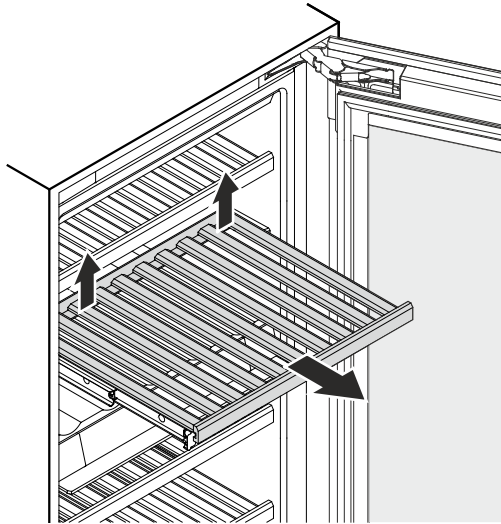

Pull the wooden shelf upwards on the right and left at the back (release) and then remove it towards you.

### Inserting the wooden shelf

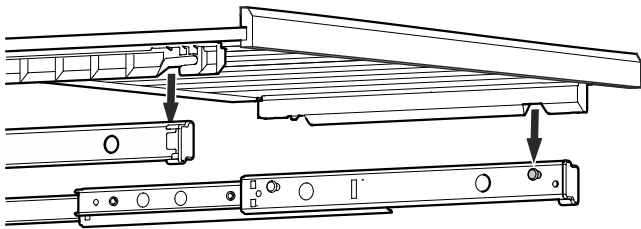

Extend the pull-out rails as far as they will go. Place the front recesses of the wooden shelf on the securing pins.

Slide the wooden shelf together with the pull-out rails into the appliance as far as they will go.

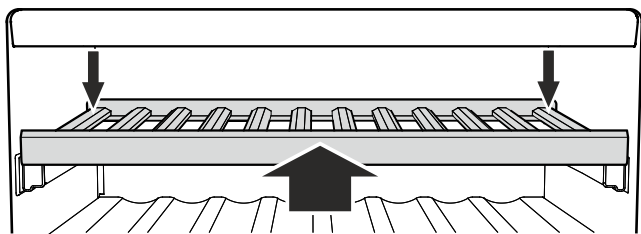

Push the wooden shelf right to the back so that it clicks into place at the front.

Push the wooden shelf downwards on the right and left at the back and click into place.

## Storage diagram

for 0.75 l Bordeaux bottles to standard NF H 35-124

### EWTgb/gw 1683

Number of bottles

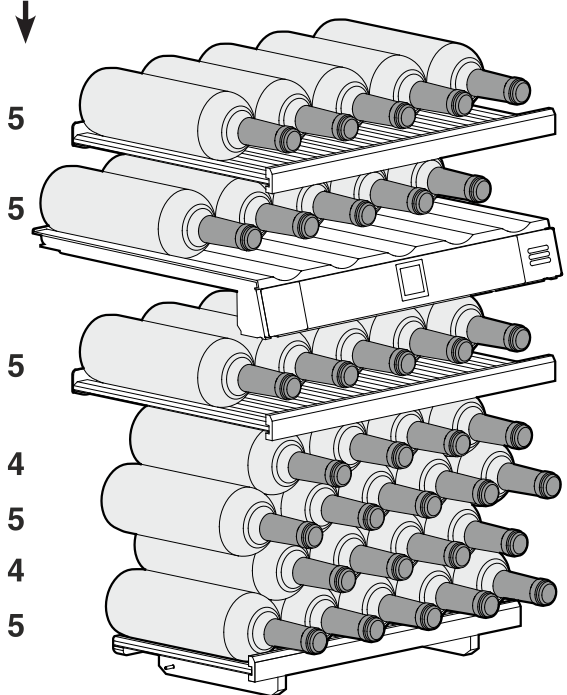

**Total 33 bottles**

### EWTgb/gw 2383

Number of bottles

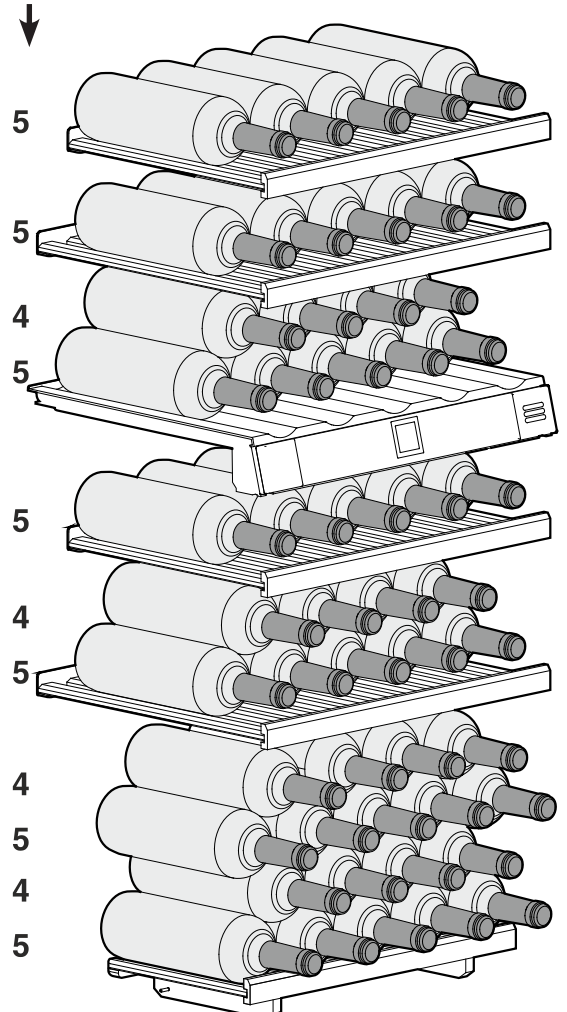

**Total 51 bottles**



**EWTgb/gw 3583**

Number of bottles

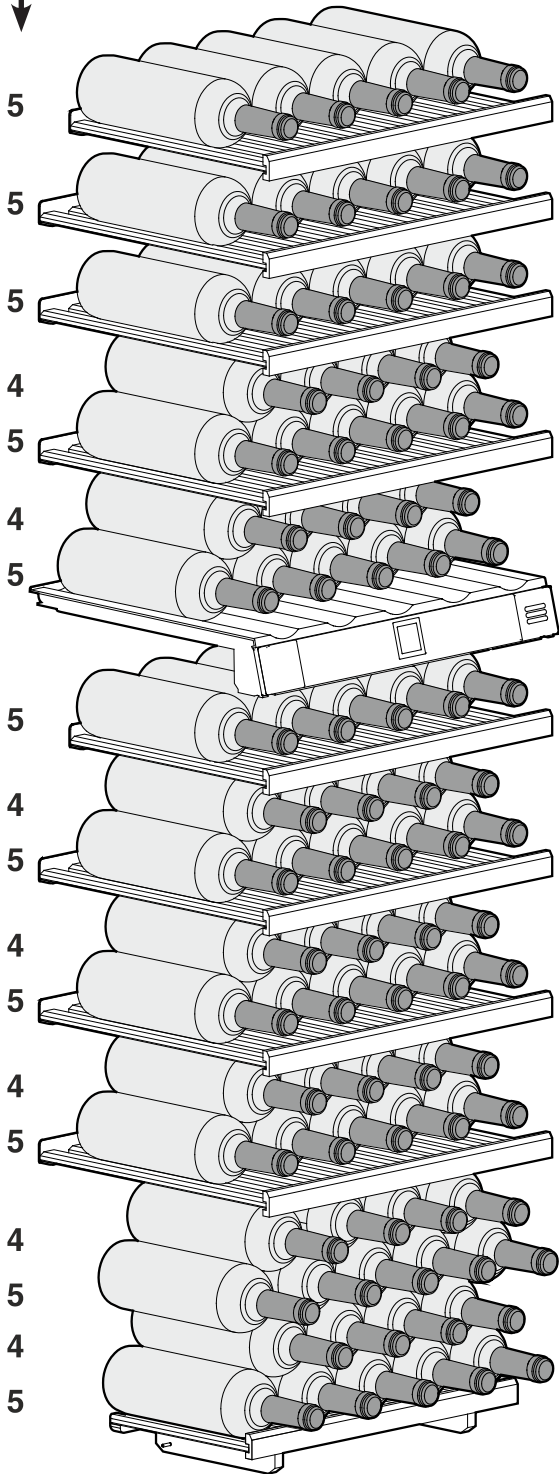

**Total 83 bottles**

**Storage diagram  
Presentation shelf**

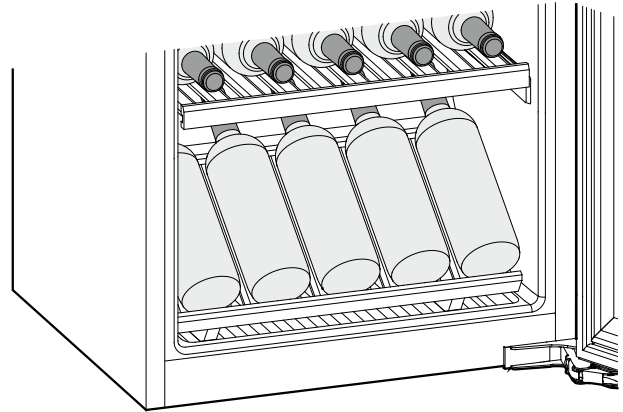
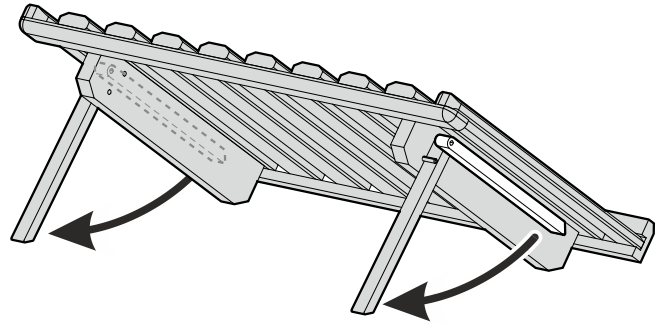

 **Important**

The maximum load per wooden shelf is 25 kg.

## Cleaning

A failure to follow these instructions may result in the food being spoilt.

### ⚠ WARNING

Before cleaning, always disconnect the appliance from the mains. Pull out the plug or switch off the fuse.

Surfaces which may come into contact with food and accessible drain systems must be cleaned at regular intervals.

If the door is left open for a lengthy period, the temperature in the appliance's compartments may rise dramatically.

- Clean the inside, equipment parts and outer walls with lukewarm water and a little detergent. Do not use chemical solvents or any cleaning agents containing sand or acid.
- Use a glass cleaner to clean the glass surfaces and a commercially available stainless-steel cleaning agent for the stainless-steel surfaces.

### ⚠ CAUTION

Risk of damage to the appliance components and risk of injury due to hot steam.

Do not use steam cleaning equipment to clean the appliance.

- Ensure that no cleaning water penetrates into the electrical components or ventilation grille.
- Dry all parts well with a cloth.
- Do not damage or remove the type plate on the inside of the appliance. It is very important for servicing purposes.

If the appliance is left empty for a lengthy period, it must be switched off, defrosted, cleaned and dried and the door is to be left open to prevent mould formation.

## Malfunctions

- **F0, F1, E1, E2, E7 or E8 appears in the display.**
  - The appliance has suffered a fault. Contact the customer service department.
- **The fans inside the appliance are running although the fan function has been deactivated and the compressor (refrigeration unit) is idle.**
  - This is a normal operating state depending on the set interior temperature and ambient temperature at the place of installation.

**You may be able to rectify the following faults by checking the possible causes yourself.**

- **Appliance does not function:**
  - Is the appliance switched on?
  - Is the plug correctly fitted in the mains socket?
  - Is the fuse intact?
- **When inserting the mains plug, the refrigeration unit does not switch on, but a value is shown in the temperature display.**
  - Demo mode is activated. Contact the customer service department.

- **Loud running noise:**
  - Is the appliance set up firmly on the floor?
  - Does the appliance cause nearby items of furniture or objects to vibrate? Please note that noises caused by the refrigerant circuit cannot be avoided.
  - Due to the various speed steps, speed-regulated compressors can generate different running noises. The sound is normal.
- **The temperature is not low enough:**
  - Is the temperature setting correct (see "Setting the temperature")?
  - Does the separately installed thermometer show the correct reading?
  - Is the ventilation system working properly?
  - Is the appliance set up too close to a heat source?
- **The compressor runs for a long time.**
  - The compressor switches to a low speed when little cold is needed. Although the running time is increased as a result, energy is saved. This is normal in energy-saving models.
- **A low hum.**
  - The sound is produced by air flow noise of the fan. The sound is normal.
- **The internal light does not come on.**
  - The appliance is not switched on. Switch the appliance on.
  - The door was open for longer than 15 minutes. The internal light switches itself off automatically after about 15 minutes if the door is open.
  - The LED illumination is faulty or the cover is damaged.

If none of the above causes apply and you cannot rectify the fault yourself, contact the nearest customer service department stating the type designation (1), service number (2) and appliance number (3) as indicated on the type plate.

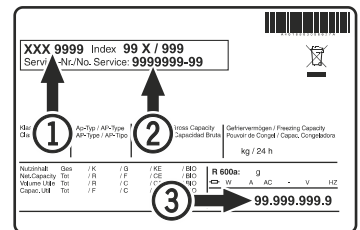

The position of the type plate is shown in the section entitled **Description of the appliance**.

## Shutting your appliance down

If your appliance is to be shut down for any length of time, switch it off and disconnect the plug or switch off or unscrew the fuse.

Clean the appliance and leave the door open in order to prevent unpleasant smells.

The appliance complies with the relevant safety regulations and EU Directives 2014/35/EU, 2014/30/EU, 2009/125/EG and 2011/65/EU.





**Liebherr Hausgeräte Lienz GmbH**  
Dr.-Hans-Liebherr-Strasse 1  
A-9900 Lienz  
Österreich  
[www.liebherr.com](http://www.liebherr.com)



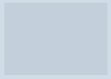

User Guide

Quality, Design and Innovation

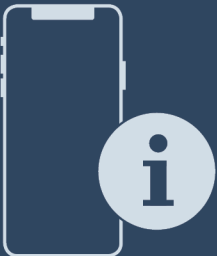



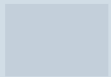













[home.liebherr.com/fridge-manuals](http://home.liebherr.com/fridge-manuals)









# LIEBHERR

# Contents

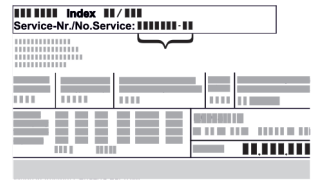
<b>1</b>	<b>Appliance at a glance.....</b>	<b>3</b>
1.1	Scope of delivery.....	3
1.2	Overview of the appliance and its equipment.....	3
1.3	SmartDevice.....	3
1.4	Appliance range of use.....	3
1.5	Conformity.....	4
1.6	SVHC substances according to REACH regulation.....	4
1.7	EPREL database.....	4
<b>2</b>	<b>General safety instructions.....</b>	<b>4</b>
<b>3</b>	<b>Putting into operation.....</b>	<b>5</b>
3.1	Switching on appliance.....	5
3.2	Inserting the components.....	6
<b>4</b>	<b>Foods management.....</b>	<b>6</b>
4.1	Storing food.....	6
4.2	Storage times.....	7
<b>5</b>	<b>Saving energy.....</b>	<b>7</b>
<b>6</b>	<b>Controls.....</b>	<b>7</b>
6.1	Controls and displays.....	7
6.1.1	Status display.....	7
6.1.2	Navigation.....	7
6.1.3	Display symbols.....	8
6.2	Control concept.....	8
6.2.1	Activating/deactivating the function.....	8
6.2.2	Selecting function value.....	8
6.2.3	Activating/deactivating settings.....	8
6.2.4	Selecting the setting value.....	8
6.2.5	Go to the Customer menu.....	8
6.3	Appliance functions.....	9
	Turn off appliance.....	9
	WiFi.....	9
	Temperature.....	10
	C-Value*.....	10
	SuperCool.....	10
	PartyMode.....	10
	HolidayMode.....	10
	SabbathMode.....	10
	EnergySaver.....	11
	CleaningMode.....	11
	Display brightness.....	11
	Door alarm.....	11
	Entry lock.....	12
	Language.....	12
	Info.....	12
	Reset.....	12
6.4	Fault messages.....	12
6.4.1	Warnings.....	12
6.4.2	DemoMode.....	12
<b>7</b>	<b>Features.....</b>	<b>13</b>
7.1	4-star freezer compartment*.....	13
7.2	Door rack.....	13
7.3	Shelves.....	14
7.4	Dividing shelf.....	14
7.5	VarioSafe*.....	15
7.6	Space for baking tray*.....	15
7.7	Drawers.....	16
7.8	EasyFresh-Safe cover.....	17
7.9	Adjusting the moisture levels.....	17
7.10	Butter dish.....	17
7.11	Egg rack.....	17
7.12	Bottle holder.....	18
7.13	Ice cube tray with cover*.....	18
<b>8</b>	<b>Maintenance.....</b>	<b>18</b>
8.1	Disassembling / assembling pull-out systems.....	18
8.2	Defrosting the appliance.....	19
8.3	Defrosting the freezer compartment manually*.....	19
8.4	Cleaning the appliance.....	19
<b>9</b>	<b>Customer help.....</b>	<b>19</b>
9.1	Technical specifications.....	19
9.2	Operating noises.....	20
9.3	Technical fault.....	20
9.4	Customer Service.....	21
9.5	Model plate.....	21
<b>10</b>	<b>Shutting down.....</b>	<b>21</b>
<b>11</b>	<b>Disposal.....</b>	<b>22</b>
11.1	Preparing appliance for disposal.....	22
11.2	Disposing of the appliance in an environmentally friendly manner.....	22

The manufacturer is continually working on the further development of all types and models. Please be aware that we reserve the right to make changes to the shape, equipment and technology.

Symbol	Explanation
	<p><b>Read instructions</b></p> <p>Please read the information in these instructions carefully to understand all of the benefits of your new appliance.</p>
	<p><b>Full instructions on the internet</b></p> <p>You can find detailed instructions on the internet using the QR code on the front of these instruction or by entering the service number at <a href="http://home.liebherr.com/fridge-manuals">home.liebherr.com/fridge-manuals</a>.</p> <p>The service number can be found on the serial tag:</p> <div style="text-align: center;">  </div> <p style="text-align: right;"><i>Fig. Example illustration</i></p>
	<p><b>Check appliance</b></p> <p>Check all parts for transport damage. If you have any complaints, please contact your agent or customer service.</p>

Symbol	Explanation
	<b>Differences</b> These instructions apply to a range of models, so differences are possible. Sections that apply to certain models only are marked with an asterisk (*).
	<b>Instructions and results</b> Instructions are marked with a ▶. Results are marked with a ▷.
	<b>Videos</b> Videos about the appliances are available on the YouTube channels of Liebherr-Hausgeräte.

These operating instructions apply to:

IRc / d 39.. / 41..

## 1 Appliance at a glance

### 1.1 Scope of delivery

Check all parts for damage during transport. If you have any complaints, please contact your retailer or Customer Services (see 9.4 Customer Service).

Your new appliance comes with the following parts:

- Built-in appliance
- Features (depending on the model)
- Installation materials (depending on the model)
- "Quick Start Guide"
- "Installation Guide"
- Service Brochure

### 1.2 Overview of the appliance and its equipment

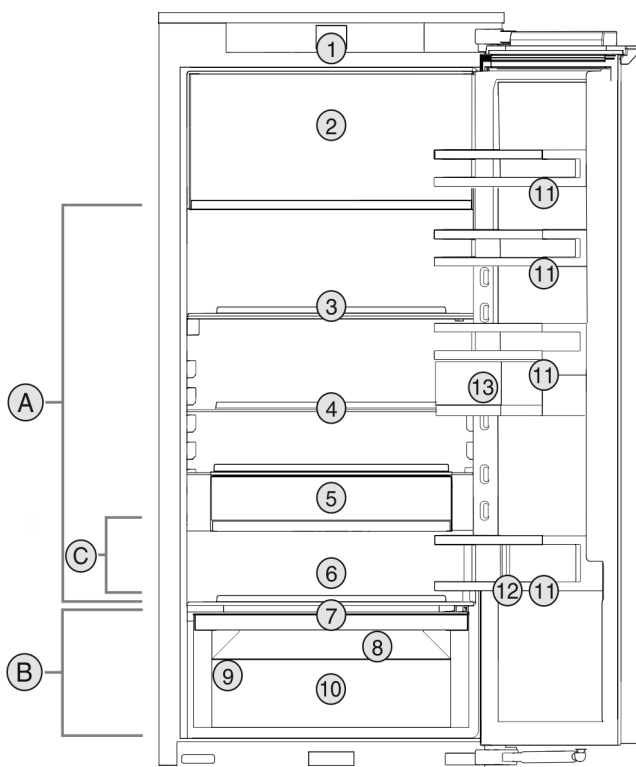

Fig. 1 Example illustration

- Temperature range**
- (A) Fridge section
  - (B) EasyFresh
  - (C) Coldest zone
- Features**
- (1) Controls
  - (2) 4-star freezer\*
  - (3) Split shelf
  - (4) Shelf
  - (5) VarioSafe\*
  - (6) Space for baking tray\*
  - (7) EasyFresh-Safe cover
  - (8) Drainage outlet
  - (9) Nameplate
  - (10) EasyFresh-Safe
  - (11) Door rack
  - (12) Bottle rack
  - (13) VarioBoxes

#### Note

▶ Shelves, drawers and baskets are arranged for optimum energy efficiency when the appliance is delivered. Changing how the shelves, for example, are inserted in the fridge compartment does not have any impact on energy consumption.

### 1.3 SmartDevice

SmartDevice is the networking solution for your refrigerator. If your appliance SmartDevice-enabled or compatible, you can quickly and easily connect your appliance to your WiFi. With the SmartDevice app, you can operate your appliance from a mobile device. Additional functions and setting options are available in the SmartDevice SmartDevice app.

SmartDevice-compatible appliance: Your appliance is compatible for use with the SmartDeviceBox. You must first purchase and install the SmartDeviceBox. In order to connect your appliance to the WiFi, you need to download the SmartDevice app.



More information about SmartDevice: [smartdevice.liebherr.com](http://smartdevice.liebherr.com)

Purchasing the SmartDeviceBox in the Liebherr-Hausgeräte store: [home.liebherr.com/shop/de/deu/smartdevicebox.html](http://home.liebherr.com/shop/de/deu/smartdevicebox.html)

Downloading the SmartDevice app:



After installing and configuring the SmartDevice, you can connect your appliance to the WiFi using the SmartDevice app and the WiFi appliance function (see WiFi).

#### Note

The SmartDevice function is not available in the following countries: Russia, Belarus, Kazakhstan. You cannot use the SmartDeviceBox.

### 1.4 Appliance range of use

#### Intended use

# General safety instructions

The appliance is only suitable for cooling food products in a domestic or household-like environment. This includes, for example, use:

- in staff kitchens, bed and breakfast establishments,
- by guests in country houses, hotels, motels and other accommodation,
- for catering and similar services in the wholesale trade.

The appliance is not suitable for freezing food;\*

All other types of use are not permitted.

## Foreseeable misuse

The following applications are expressly forbidden:

- Storing and refrigerating medicines, blood plasma, laboratory preparations or similar substances and products based on the Medical Device Directive 2007/47/EC
- Use in areas at risk of explosions

Misusing the appliance may lead to damage to the goods stored or they may spoil.

## Climate classifications

Depending on the climate classification the appliance is designed to operate in restricted ambient temperatures. The climate classification applying to your appliance is printed on the rating plate.

## Note

► Keep to the specified ambient temperatures in order to guarantee that the appliance works properly.

Climate classification	for ambient temperatures of
SN	10 °C to 32 °C
N	16 °C to 32 °C
ST	16 °C to 38 °C
T	16 °C to 43 °C
SN-ST	10 °C to 38 °C
SN-T	10 °C to 43 °C

## 1.5 Conformity

The refrigerant circuit has been tested for leaks. When installed, the appliance complies with the applicable safety regulations and with the corresponding directives.

The full text of the EU Declaration of Conformity is available on the following website: [www.Liebherr.com](http://www.Liebherr.com)

## 1.6 SVHC substances according to REACH regulation

You can check whether your appliance contains SVHC substances according to REACH regulation at the following

link: [home.liebherr.com/de/deu/de/liebherr-erleben/nachhaltigkeit/umwelt/scip/scip.html](http://home.liebherr.com/de/deu/de/liebherr-erleben/nachhaltigkeit/umwelt/scip/scip.html)

## 1.7 EPREL database

Details about energy labelling and ecodesign requirements will be available on the European product database (EPREL) from 1st March 2021. You can access the product database at the following link: <https://eprel.ec.europa.eu/> You will be asked to enter the model ID. You can find the model ID on the nameplate.

# 2 General safety instructions

Please keep these operating instructions in a safe place so you can refer back to them at any time.

If you pass the appliance on, please hand these operating instructions to the next user.

Read these operating instructions carefully before use to ensure safe and correct use of the appliance. Follow the instructions, safety instructions and warning messages included at all times. They are important for ensuring you can operate and install the appliance safely and without any problems.

## Danger for the user:

- This device can be used by children and people with impaired physical, sensory or mental abilities or with a lack of experience and knowledge provided that they are supervised or have received instruction in the safe use of this device, and about the resulting hazards. Children must not play with this appliance. Cleaning and user maintenance work must not be carried out by children without adult supervision. Children aged between 3 and 8 are allowed to load and unload the appliance. Children below the age of 3 must be kept away from the appliance unless they are under continuous adult supervision.
- The socket must be easily accessible so that the appliance can be disconnected quickly from the electricity in an emergency. It must not be located in the area behind the appliance.
- When disconnecting the appliance from the supply, always take hold of the plug. Do not pull the cable.
- In the event of a fault pull out the mains plug or deactivate the fuse.
- Do not damage the mains power cable. Do not operate the appliance with a defective mains power cable.
- Only customer service or other specially trained staff may repair or perform other operations on the appliance.

- Only install, connect and dispose of the appliance according to the instructions.
- Only use the appliance when is installed.

## Fire hazard:

- The coolant used (information on the model plate) is ecofriendly but also flammable. Any leaking coolant may ignite.
  - Do not damage the refrigerant circuit pipes.
  - Do not handle ignition sources inside the appliance.
  - Do not use electrical appliances inside the appliance (e.g. steam cleaners, heaters, ice cream makers, etc.).
  - If the refrigerant leaks: remove any naked flames or ignition sources from the vicinity of the leakage point. Properly air the room. Inform customer services.
- Do not store explosives or sprays using combustible propellants such as butane, propane, pentane, etc. in the appliance. To identify these spray cans, look for the list of contents printed on the can, or a flame symbol. Gases possibly escaping may ignite due to electrical components.
- Keep burning candles, lamps and other items with naked flames away from the appliance so that they do not set the appliance on fire.
- Please be sure to store alcoholic drinks or other packaging containing alcohol in tightly closed containers. Any alcohol that leaks out may be ignited by electrical components.

## Danger of tipping and falling:

- Do not misuse the plinth, drawers, doors etc. as a step or for support. This applies particularly to children.

## Danger of food poisoning:

- Do not consume food which has been stored too long.

## Danger of frostbite, numbness and pain:

- Avoid prolonged skin contact with cold surfaces or refrigerated/frozen goods or take protective measures, e.g wear gloves.

## Danger of injury and damage:

- Hot steam can lead to injury. Do not use electrical heating or steam cleaning equipment, open flames or defrosting sprays to defrost.
- Do not use sharp implements to remove the ice.

## Risk of crushing:

- Do not hold the hinge when opening and closing the door. Fingers may get caught.

## Symbols on the appliance:



This symbol may be located on the compressor. It relates to the oil in the compressor and makes reference to the risk that: Swallowing or inhaling can be fatal. This advice is only relevant to recycling. There is no danger in normal operation.



This symbol is located on the compressor and indicates the danger of flammable materials. Do not remove the sticker.



This or a similar sticker may be located on the rear of the appliance. This sticker indicates that there are vacuum insulation panels (VIP) or perlite panels in the door and/or housing. This advice is only relevant to recycling. Do not remove the sticker.

## Please note the warning messages and other specific advice in the other chapters:

	DANGER	indicates an immediately hazardous situation which will lead to death or serious injuries if it is not avoided.
	WARNING	indicates a hazardous situation which may lead to death or serious injuries if it is not avoided.
	CAUTION	indicates a hazardous situation which may lead to minor or moderate injuries if it is not avoided.
	NOTICE	indicates a hazardous situation which may lead to damage to property if it is not avoided.
	Note	indicates useful instructions and tips.

## 3 Putting into operation

### 3.1 Switching on appliance

Ensure that the following conditions are met:

- Appliance is installed and connected according to installation instructions.
- All adhesive strips, adhesive and protective films as well as transport safety devices in and on the appliance are removed.
- All marketing leaflets are removed from the drawers.

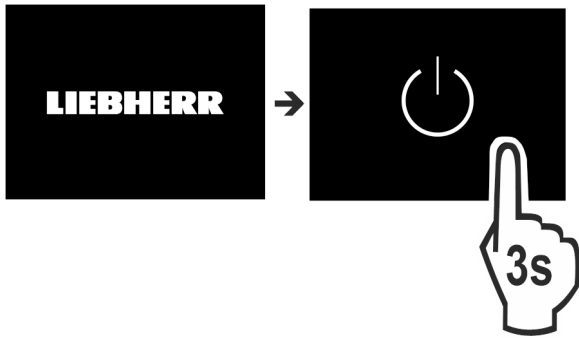

Fig. 2

- ▶ Switch on the appliance using the display.

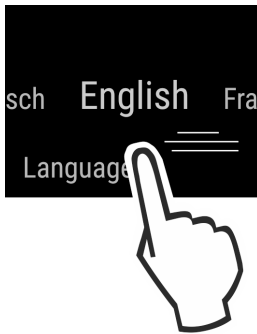

Fig. 3

- ▶ Select the language.
- ▷ The status display appears.

### The appliance starts in DemoMode:

If the appliance starts in DemoMode, you can deactivate DemoMode within the next 5 minutes.

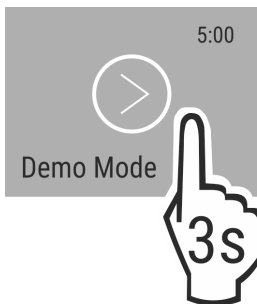

Fig. 4

- ▶ Press DemoMode for 3 seconds.
- ▷ DemoMode is deactivated.

### Note

- The manufacturer recommends:
- ▶ Place the food inside: Wait for around 6 hours until the set temperature is reached.
  - ▶ **Store frozen foods** at -18 °C or colder.\*

## 3.2 Inserting the components

### Note

Accessories can be purchased from the Liebherr-Hausgeräte store at [home.liebherr.com/shop/de/deu/zubehor.html](http://home.liebherr.com/shop/de/deu/zubehor.html).

- ▶ Insert the supplied components to make the most of your appliance.

## 4 Foods management

### 4.1 Storing food



### WARNING

Risk of fire

- ▶ Do not use any electrical appliances in the food area of the appliance unless recommended by the manufacturer.

### Note

The energy consumption increases and the cooling power goes down if ventilation is not sufficient.

- ▶ Always keep air slots clear.

When storing food, always observe the following:

- Air vents on the inside rear wall are unobstructed.
- Food is in sealed packaging.
- Foods that easily absorb or give off smell or taste are stored in sealed containers or covered.
- Raw meat and fish are in clean, sealed containers to prevent them coming into contact with or dripping onto other foods.
- Liquids are in sealed containers.
- Foods are not stored too closely together, as the air needs to circulate.

### Note

Failure to follow these guidelines can lead to food perishing.

#### 4.1.1 Fridge section

The natural air circulation creates a range of temperatures.

#### Arrange your food as follows:

- ▶ In the top section and in the door: butter and cheese, preserves and tubes.
- ▶ In the coldest zone Fig. 1 (C): Perishable foods such as ready-to-eat meals, meat and sausages
- ▶ On the bottom shelf: Raw meat and fish

#### 4.1.2 EasyFresh-Safe

This compartment is great for non-packaged foods, such as fruit and vegetables.

The air moisture in the compartment depends on the moisture content of the items being stored and the number of times the door is opened. You can adjust the air moisture.

#### Arrange your food as follows:

- ▶ Store your loose fruit and vegetables.
- ▶ Excessive air moisture: Regulate the air humidity (see 7.9 Adjusting the moisture levels) .

#### 4.1.3 Freezer compartment\*

The air temperature can vary in the compartment when shown on a thermometer or other gauges. The temperature varies more when the compartment is half-full or empty and can rise to more than -18 °C.

#### Freezing food

You can freeze as many kilograms of fresh food within 24 hours as is indicated on the model plate .

So that the food is rapidly frozen through to the core, keep to the following quantities per pack:

- Fruit, vegetables up to 1 kg
- Meat up to 2.5 kg

#### Arrange your food as follows:





## CAUTION

Risk of injury from glass fragments!  
 Drink bottles and cans may explode if frozen. This applies particularly to carbonated drinks.

▶ Do not freeze bottles and cans of drink!

▶ Put the packaged food into the freezer compartment so that it is in contact with the floor or the side walls.

## Defrost the food

- In the fridge
- In the microwave
- In the stove/oven
- At room temperature



## WARNING

Risk of food poisoning!

▶ Do not re-freeze thawed food.  
 ▶ Use defrosted foodstuff as soon as possible.

▶ Only take out the food you need at the time.  
 ▶ Cook defrosted food as soon as possible.

## 4.2 Storage times

Refer to the specified storage times as a guide.

In the case of foods with a minimum shelf life, the date indicated on the packaging still applies.

### 4.2.1 Fridge section

Always follow the best-before date stated on the packaging.

### 4.2.2 Freezer compartment\*

Recommended shelf-lives for various types of food		
Ice cream	at -18 °C	2 to 6 months
Cold cuts, ham	at -18 °C	2 to 3 months
Bread, baked goods	at -18 °C	2 to 6 months
Game, pork	at -18 °C	6 to 9 months
Fatty fish	at -18 °C	2 to 6 months
Lean fish	at -18 °C	6 to 8 months
Cheese	at -18 °C	2 to 6 months
Poultry, beef	at -18 °C	6 to 12 months
Vegetables, fruit	at -18 °C	6 to 12 months

## 5 Saving energy

- Pay attention to good ventilation. Do not cover ventilation holes or grids.
- Do not install the appliance in direct sunlight, next to an oven, radiator or similar.
- Energy consumption depends on the installation conditions, e.g. the ambient temperature (see 1.4 Appliance range of use) . A warmer ambient temperature can increase the energy consumption.
- Open the appliance for as short a time as possible.
- The lower the temperature is set the higher the energy consumption.
- Sort your food: [home.liebherr.com/food](http://home.liebherr.com/food).
- Keep all food properly packed and covered. This prevents frost from forming.

- Only take food out for as long as necessary so that it doesn't warm up too much.
- Inserting warm food: allow to cool down to room temperature first.
- Thaw frozen food in the refrigerator.\*
- If there is a thick layer of frost in the appliance: defrost the appliance.\*
- For longer periods of absence, use HolidayMode (see HolidayMode) .

## 6 Controls

### 6.1 Controls and displays

The display gives you a quick overview of the temperature setting and the status of functions and settings. Select or adjust functions by activating/deactivating or selecting a value.

#### 6.1.1 Status display

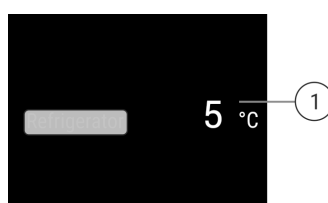

Fig. 5

(1) Temperature display of the fridge section

#### 6.1.2 Navigation

Navigate in the menu to access the individual functions. An audible signal sounds after confirming a function or setting. If no selection is made after 10 seconds, the display switches to the Status display.





Navigation	Description
	<b>Press briefly</b> Activate/deactivate function. Confirm selection. Open submenu.
	<b>Long press (3 seconds)</b> Activate/deactivate function. Increasing/decreasing bar appears in the display. Confirm selection. Reset appliance/values. Switch appliance on/off.
	<b>Swipe</b> Navigate in the menu. Search for values.

# Controls

Navigation	Description
	<b>Briefly press "Back" symbol</b> Display goes back one level.
No action for 10 seconds	Display switches to the Status display.

## 6.1.3 Display symbols





Display symbols provide information on the current appliance status:

Symbol	Appliance status
	<b>Standby</b> The appliance or temperature zone is switched off.
	<b>Flashing number</b> Appliance is working. Temperature flashes until the set temperature is reached.
	
	<b>Flashing symbol</b> Appliance is working. Setting is made.
	

## 6.2 Control concept

### 6.2.1 Activating/deactivating the function

You can activate/deactivate the following functions:

Symbol	Function
	SuperCool <sup>x</sup>
	PartyMode <sup>x</sup>
	HolidayMode
	EnergySaver

<sup>x</sup> When function is on, the appliance works harder. This means appliance noise when operating may be louder for a short while, and more energy will be consumed.

- ▶ Swipe left in the display until the function appears.
- ▶ Confirm selected function with a short tap.
- ▷ You hear the confirmation tone.
- ▷ Status appears in the menu.
- ▷ Function is on/off.

### 6.2.2 Selecting function value

With the following functions you can set a value in the submenu:







Symbol	Function
	Setting the temperature Switch the appliance on/off

- ▶ Swipe left in the display until the function appears.
- ▶ Confirm selected function with a short tap.

- ▶ Select the setting value by swiping the display.
- ▶ Press briefly to confirm the selected value.

### 6.2.3 Activating/deactivating settings

You can activate/deactivate the following settings:

Symbol	Setting
	WiFi <sup>1</sup>
	Entry lock <sup>2</sup>
	SabbathMode <sup>2</sup>
	Cleaning Mode <sup>2</sup>
	Reset <sup>2</sup>
	Switch off <sup>2</sup>

- ▶ Swipe left in the display until Settings  appears.
- ▶ Tap to confirm settings.
- ▶ Swipe until you see the setting you want.

#### <sup>1</sup> Activate setting (shortpress)



- ▶ Tap briefly to confirm.
- ▷ You hear the confirmation tone.
- ▷ Status appears in the menu.
- ▷ Setting is on / off.

#### <sup>2</sup> Activate setting (longpress)

- ▶ Press the selection for 3 seconds to confirm.
- ▷ You hear the confirmation tone.
- ▷ Status appears in the menu.
- ▷ Display changes.

### 6.2.4 Selecting the setting value



With the following settings you can set a value in the submenu:



Symbol	Settings
	Brightness
	Door alarm
	Language

- ▶ Swipe left in the display until Settings  appears.
- ▶ Tap to confirm settings.
- ▶ Swipe until you see the setting you want.
- ▶ Tap briefly to confirm.
- ▶ Select the desired setting value by swiping the display.
- ▶ Tap briefly to confirm.
- ▷ You hear the confirmation tone.
- ▷ Status appears briefly in the submenu.
- ▷ Display switches back to the menu.

### 6.2.5 Go to the Customer menu

You can see the following settings in the Customer menu:

Symbol	Function
	C-Value <sup>1*</sup>
	Software

- ▶ Swipe left in the display until the settings  appear.
- ▶ Tap settings.
- ▷ The submenu appears.
- ▶ Swipe left in the display until the appliance information  appears.
- ▶ Press for 3 seconds.
- ▷ The input menu for a numerical code appears.
- ▶ Enter the numerical code 151.
- ▷ The customer menu appears.
- ▶ Swipe left in the display until the desired setting appears.

### <sup>1</sup> Select the value

- ▶ Confirm with a short tap.
- ▷ You hear the confirmation tone.
- ▷ Status appears briefly in the display.
- ▷ Display switches back to the menu.

### <sup>2</sup> Activate the setting

- ▶ To confirm, press the display for 3 seconds.
- ▷ You hear the confirmation tone.
- ▷ Status appears on the display.
- ▷ The symbol flashes as long as the appliance is working.

## 6.3 Appliance functions



### Turn off appliance

This setting turns off the whole appliance.

#### Switching off the entire appliance

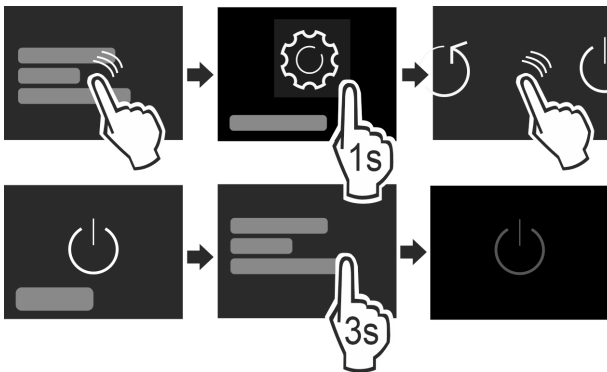

Fig. 6

- ▶ Activating/deactivating (see 6.2 Control concept) .
- ▷ Off: Display goes black.



### WiFi

Use this function to connect your appliance to WiFi. You can then operate it via the SmartDevice app on a mobile device. You can also use this function to disconnect or reset the WiFi connection.

To connect your device to WiFi, you need the SmartDeviceBox.

More information on the SmartDevice: (see 1.3 SmartDevice)

### Note

The SmartDevice function is not available in the following countries: Russia, Belarus, Kazakhstan.

You cannot use the SmartDeviceBox.

### Establishing a WiFi connection

Make sure that the following requirements are fulfilled:

- You have purchased and inserted a SmartDeviceBox. (see 1.3 SmartDevice)
- You have installed the SmartDevice app (see [apps.home.liebherr.com](https://apps.home.liebherr.com)).
- Registration in the SmartDevice app is completed.

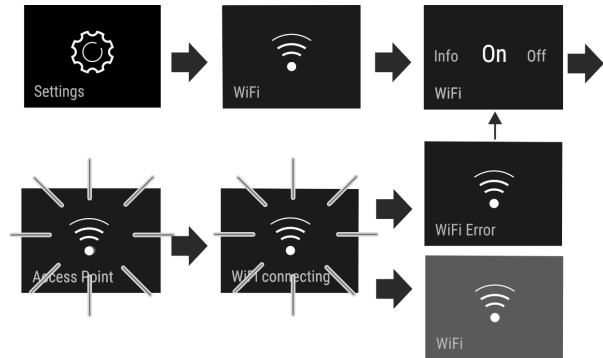

Fig. 7

- ▶ Activate the setting. (see 6.2 Control concept)
- ▷ Connection is established: Connecting appears. The symbol flashes.
- ▷ Connection is established: WiFi appears, the display turns blue.
- ▷ Connection failed: WiFi Error appears.

### Disconnecting from the WiFi

- ▶ Deactivate the setting. (see 6.2 Control concept)

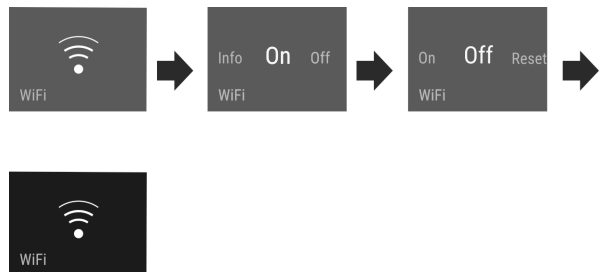



Fig. 8

- ▷ There is no connection: Symbol  is permanently visible.

### Resetting the WiFi connection

- ▶ Reset settings. (see 6.2 Control concept)

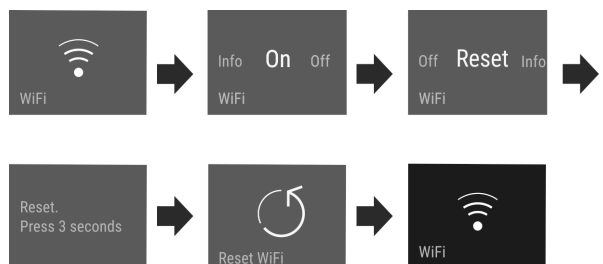

Fig. 9

- ▷ The connection and other settings are reset to the factory settings.

# Controls

## 5 °C Temperature

Use this function to set the temperature.

The temperature depends on the following factors:

- How often the door is opened
- How long the door is open for
- The room temperature of the installation site
- The type, temperature and amount of food

Temperature zone	Recommended setting
------------------	---------------------

5 °C	Fridge compartment	5 °C
------	--------------------	------

### Setting temperature

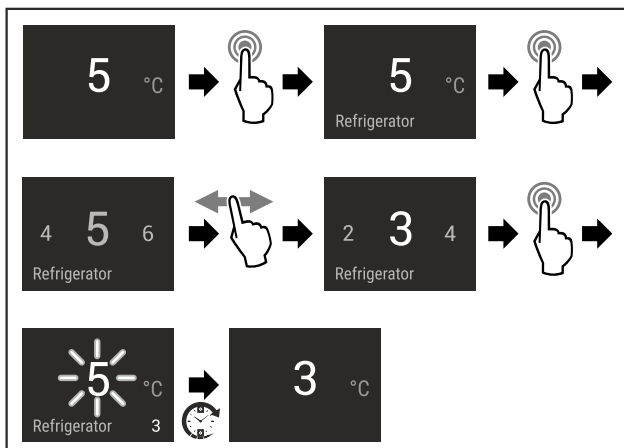

Fig. 10

- ▶ Carry out action steps according to the illustration.
- ▷ Temperature is set.

## C5 C-Value\*

The *C-Value* enables the 4-star freezer compartment to be set to a slightly warmer or colder temperature.\*

The *C-Value* is set to **C5** by default.\*

The 4-star freezer compartment becomes colder if the value is set to less than **C5**. The 4-star freezer compartment becomes warmer if the value is set to more than **C5**.\*

### Selecting the setting value\*

- ▶ Set value in customer menu (see 6.2 Control concept) .

## SuperCool

This function selects the lowest cooling temperature. This gives you colder storage temperatures.

This function is relevant to the fridge section Fig. 1 (A)

You can also reach lower temperatures in the 4-star freezer.\*

Use:

- Cool large amounts of food quickly.
- Freeze food.\*

### Activating/deactivating the function

- ▶ Using the 4-star freezer: activate the function when you add the goods.\*
- ▶ Using the fridge section: activate the function when you add the goods.
- ▶ Activating/deactivating (see 6.2 Control concept) .

The function automatically turns off. The appliance goes back to normal mode. The temperature adjusts itself to the set level.

## PartyMode

This option offers an assortment of special functions and settings that are useful if you are having a party.

The following functions are on:

- *SuperCool*

All the functions can be adjusted flexibly and separately. Changes are discarded when the function turns off.

### Activating/deactivating the function

- ▶ Activating/deactivating (see 6.2 Control concept) .
- ▷ On: All functions are activated at the same time.
- ▷ Deactivated: Previously set temperatures are restored.

After 24 hours the function turns off automatically.

## HolidayMode

This function minimises the energy consumption during an extended absence. The temperature of the refrigerator compartment is set to 15 °C and this is displayed on the status screen when the temperature has been reached.

Use:

- Save energy if you plan to be away for a while.
- Avoid coming home to bad smells and mould.

### Activating/deactivating the function

- ▶ Empty everything from the fridge section.
- ▶ Activating/deactivating (see 6.2 Control concept) .
- ▷ On: Fridge temperature is raised.
- ▷ Off: the previously set temperature is restored.

## SabbathMode

With this function you can activate or deactivate the SabbathMode. If you activate this function, some electronic functions will be switched off. This allows your appliance to meet religious requirements on Jewish holidays such as the Sabbath and comply with STAR-K Kosher certification.

Appliance status with active SabbathMode
The status display continuously shows SabbathMode.
All functions in the display except the <b>Deactivate SabbathMode function</b> are locked.
Active functions remain active.
The display stays lit when you close the door.
The interior lighting is off.
Reminders are disabled. The set time intervals are paused.
Reminders and warnings are not displayed.
There is no door alarm.
There is no temperature alarm.
The defrost cycle only works for the specified time without taking account of appliance use.
After a power failure, the appliance returns to SabbathMode.

Appliance status

## Note

This appliance has certification from the “Institute for Science and Halacha”. ([www.machonhalacha.co.il](http://www.machonhalacha.co.il))

You can find a list of STAR-K-certified appliances at [www.star-k.org/appliances](http://www.star-k.org/appliances).

## Activating SabbathMode



### WARNING

Danger of food poisoning from spoiled food!

If you have SabbathMode activated and a power failure occurs, no message appears in the status display about the power failure. Once the power is restored, the appliance continues to operate in SabbathMode. The power failure may mean that food spoils and the consumption of this food could lead to food poisoning.

After a power failure:

- ▶ Do not consume food that was frozen and has thawed out.

- ▶ Call up the settings menu. (see 6.2 Control concept)
- ▶ Swipe left or right until corresponding function is displayed.

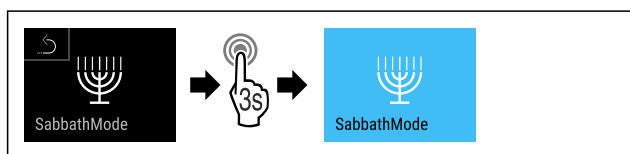

Fig. 11

- ▶ Carry out action steps according to the illustration.
- ▷ SabbathMode is activated.
- ▷ Status display continuously shows SabbathMode.

## Deactivating SabbathMode

- ▶ Call up the settings menu. (see 6.2 Control concept)
- ▶ Swipe left or right until corresponding function is displayed.

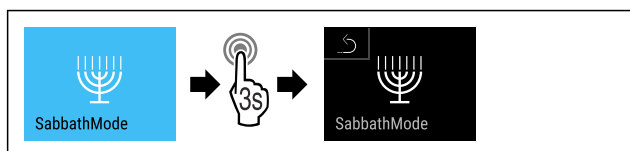

Fig. 12

- ▶ Carry out action steps according to the illustration.
- ▷ SabbathMode is deactivated.

## EnergySaver

This function activates or deactivates the energy-saving mode. When you activate this function, the energy consumption decreases and the temperature increases by 2 °C in the appliance. The food remains fresh, but the shelf life is shortened.

Temperature zone	Recommended setting	Temperature when EnergySaver activated
5 °C Fridge compartment	5 °C	7 °C

Temperatures

## Activating EnergySaver

- ▶ Swipe left or right until corresponding function is displayed.

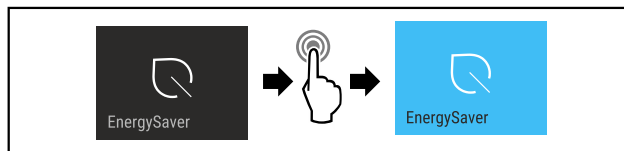

Fig. 13

- ▶ Carry out action steps according to the illustration.
- ▷ Energy-saving mode is activated.

## Deactivating EnergySaver

- ▶ Swipe left or right until corresponding function is displayed.

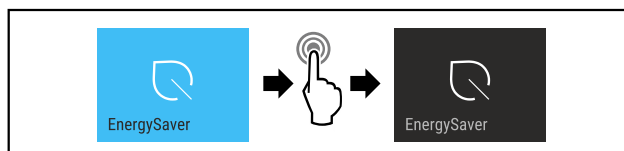

Fig. 14

- ▶ Carry out action steps according to the illustration.
- ▷ Energy-saving mode is deactivated.



## CleaningMode

Use this setting to easily clean the appliance. This setting refers to the fridge section Fig. 1 (A).

Use:

- Clean the fridge section by hand.

What happens on the appliance when this setting is on:

- The display permanently shows: CleaningMode.
- The fridge section is switched off.
- Reminders and warnings are not shown. There is no acoustic signal.

## Activating/deactivating settings

- ▶ Activating/deactivating the setting (see 6.2 Control concept).
- ▷ On: fridge section is off. Light stays on.
- ▷ Off: preset temperature is restored.

After 60 min the setting turns off automatically. The appliance then continues running in normal mode.



## Display brightness

Set the brightness level of the display.

You can set the following brightness levels:

- 40%
- 60%
- 80%
- 100%

## Choose the setting

- ▶ Set the level (see 6.2 Control concept).



## Door alarm

Set the time before the door alarm (see Close the door) sounds.

The options are as follows:

- 1 min
- 2 min

# Controls

- 3 min
- Off

## Choose the setting

- ▶ Set the time (see 6.4 Fault messages) .



## Entry lock

This setting prevents unintentional use of the appliance, e.g. by children.

Use:

- Avoid settings being changed unintentionally.
- Avoid the appliance being switched off unintentionally.
- Avoid the temperature being changed unintentionally.

## Activating/deactivating settings

- ▶ Activating/deactivating. (see 6.2 Control concept)

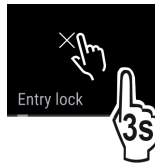

## Language

This setting lets you choose the language of the display.

Choose from the following languages:

- German
- English
- French
- Spanish
- Italian
- Dutch
- Czech
- Polish
- Portuguese
- Russian
- Chinese

## Activating/deactivating settings

- ▶ Activating/deactivating (see 6.2 Control concept) .



## Info

This setting allows the appliance information to be read out as well as access to the customer menu.

It provides the following information:

- Model name
- Index
- Serial number
- Service number

## Show appliance data

- ▶ Swipe in the display until Settings  appears.
- ▶ Confirm the display.
- ▶ Swipe in the display until About appears.
- ▶ Read the appliance info.



## Reset

This function resets all settings to the factory settings. All settings that you have made thus far will be reset to their original values.

## Activating the setting

- ▶ Activate (see 6.2 Control concept) .

## 6.4 Fault messages

Fault messages appear in the display. There are two categories of fault message:

Category	Meaning
Message	Reminder of general procedures. You can carry out these procedures to eliminate the message.
Warning	Appears when there are malfunctions. A signal sounds in addition to the display. The signal becomes louder until you acknowledge by tapping the display. You can eliminate simple defects yourself. For more serious defects, you must contact customer service.

### 6.4.1 Warnings



#### Close the door

This message appears if the door is open for too long.

You can set how long it takes for this message to appear .

- ▶ Stop alarm: Confirm the message.

-or-

- ▶ Close the door.



#### Error

This message appears if there is a fault with the appliance. An appliance component indicates a fault.

- ▶ Open the door.
- ▶ Note down the fault code.
- ▶ Confirm the message.
- ▷ The signal tone stops.
- ▷ The status display appears.
- ▶ Close the door.
- ▶ Contact customer service. (see 9.4 Customer Service)

### 6.4.2 DemoMode

If "D" appears on the display, demo mode is on. This option is designed for retailers, as it turns off all the cooling functions.

#### Stopping DemoMode

If you see the following running in the display:

- ▶ Confirm the display within the countdown.
- ▷ DemoMode is off.
- If the timer is not running:
- ▶ Unplug the appliance.
- ▶ Plug the appliance in again.
- ▷ DemoMode is off.

## 7 Features

### 7.1 4-star freezer compartment\*

#### 7.1.1 Opening/closing the freezer compartment

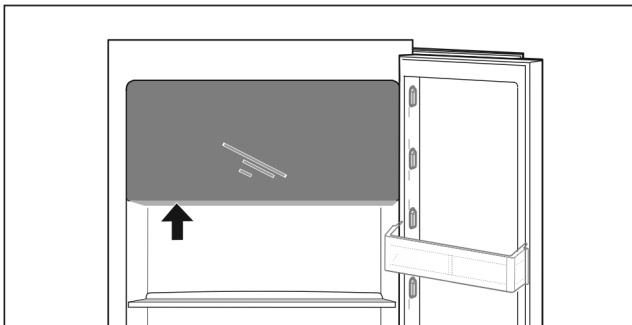
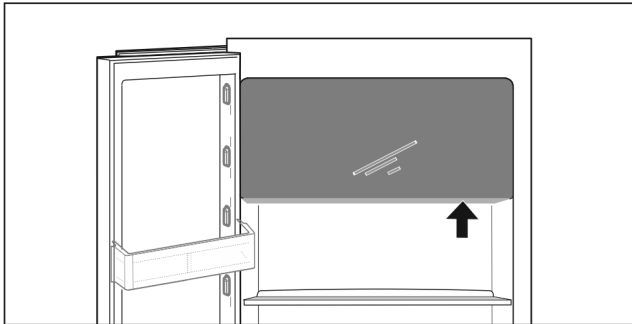

Fig. 15

Opening the freezer compartment:

- ▶ Reach into the handle area from below.
- ▶ Push the handle plate while pulling the door towards you.

Closing the freezer compartment:

- ▶ Close the door while pushing from the front.
- ▷ Door is engaged.

### 7.2 Door rack

#### 7.2.1 Move/remove the door rack

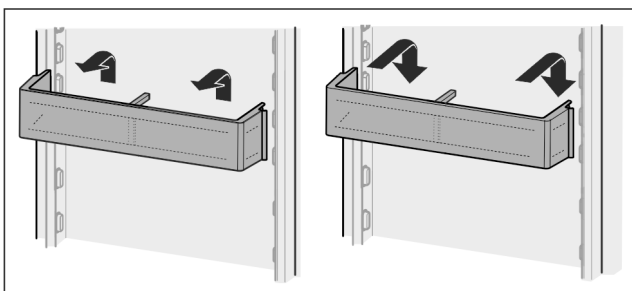

Fig. 16

- ▶ Slide the rack upwards.
- ▶ Pull forwards.
- ▶ Re-insert it in reverse order.

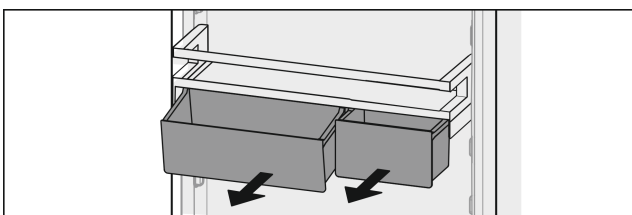

Fig. 17

You can use just one or both VarioBoxes. To store oversized bottles, just suspend one box over the bottle rack.

#### Move the VarioBox shelf:

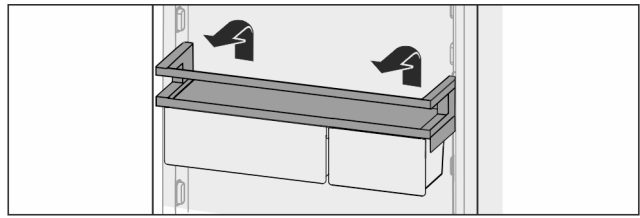

Fig. 18

- ▶ Pull it up and out.
- ▶ Put it back in at any position.
- ▷ In front of 4-star freezer: Optimum air flow in the appliance is no longer guaranteed. Condensate may form on the freezer compartment.\*

#### Note

Liebherr recommends the following:\*

- ▶ Put the VarioBox shelf in its default position, anywhere below the 4-star freezer. This will provide the best air flow in the fridge section.\*

#### Moving the VarioBoxes:

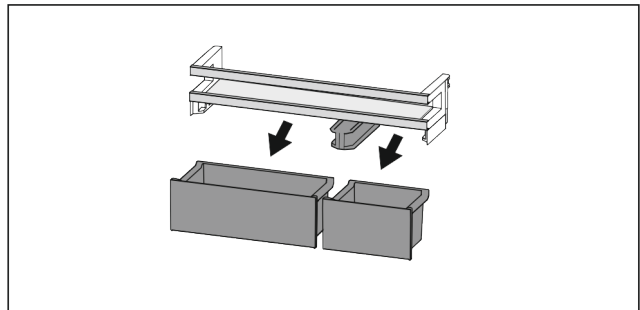

Fig. 19

If the door rack is removed:

- ▶ Remove containers.

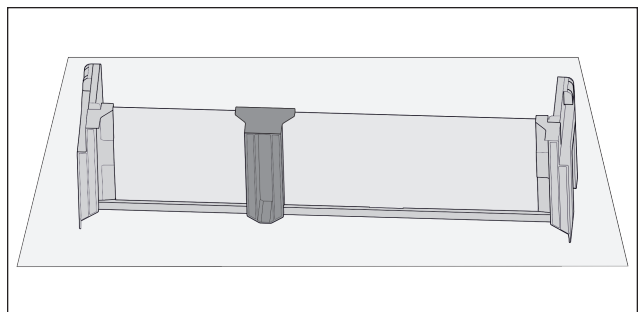

Fig. 20

- ▶ Place the shelf on the table.

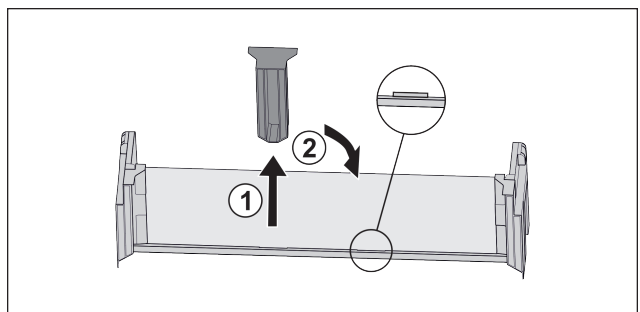

Fig. 21

- ▶ Pull off the middle holder Fig. 21 (1).
- ▶ Insert the middle holder in the second position Fig. 21 (2).



# Features

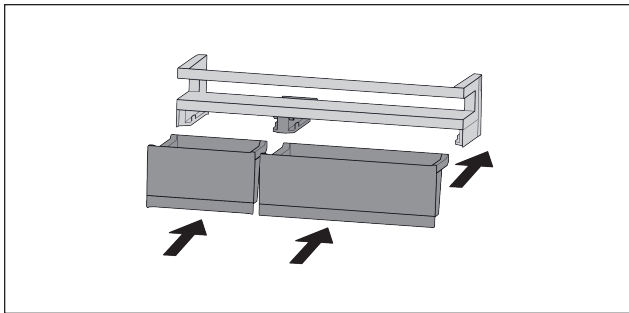

Fig. 22

- ▶ Replace containers.

## 7.2.2 Disassembling the door rack

The door rack can be taken apart for cleaning.

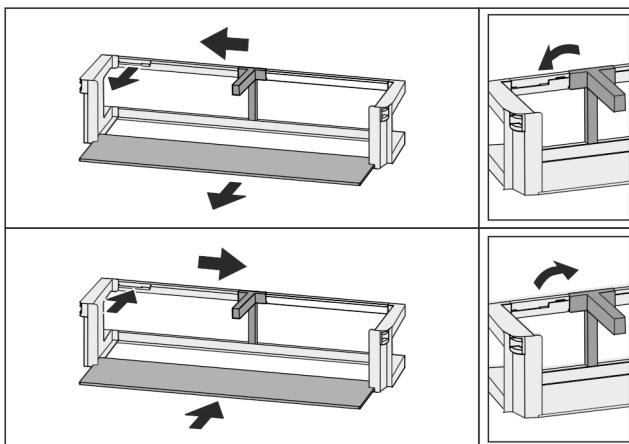

Fig. 23

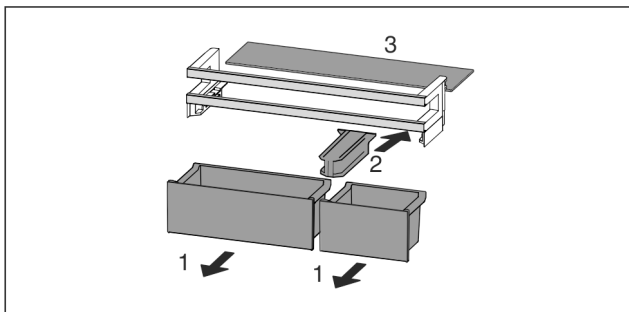

Fig. 24

- ▶ Disassemble the door rack.

## 7.3 Shelves

### 7.3.1 Adjusting/removing the shelves

The shelves are prevented from being pulled out accidentally by pull out stops.

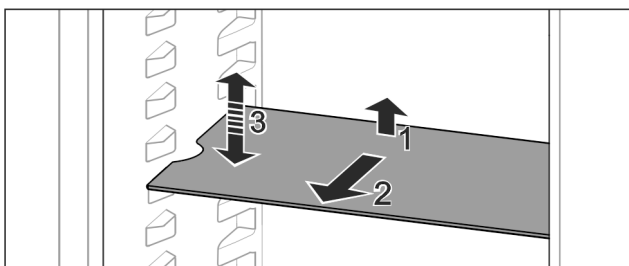

Fig. 25

- ▶ Lift the shelf and pull forward.
- ▷ Line up the side runner.

- ▶ Adjust the height of the shelf: Lift or lower it to the desired height and slide it in.

-or-

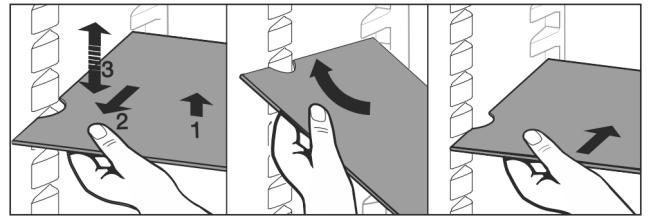

Fig. 26

- ▶ Remove the shelf completely: Pull it out to the front.

- ▶ Easier removal: Set the shelf at an angle.
- ▶ Insert the shelf again: Slide it in all the way.
- ▷ The pull-out stoppers point downwards.
- ▷ The pull-out stoppers are behind the front support.

You can also remove the shelf above the EasyFresh compartments.

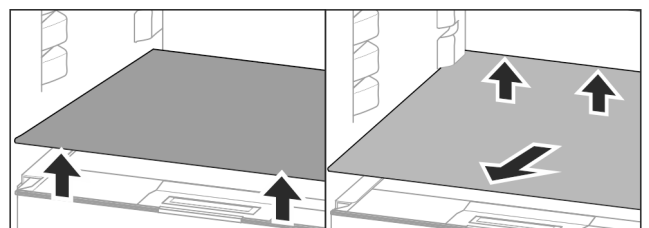

Fig. 27

Removing the shelf:

- ▶ Lift the shelf at the front and back.
- ▶ Pull it out towards you.

Do not store any goods on the compartment cover below!

Inserting the shelf:

- ▶ Place the shelf at an angle, sloping down towards the back.
- ▷ The pull-out stoppers point downwards.
- ▶ Slide the shelf into place.

### 7.3.2 Dismantling the shelves

The shelves can be dismantled for cleaning.

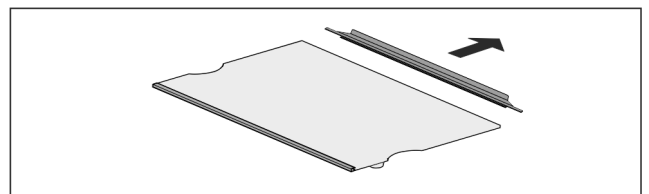

Fig. 28

- ▶ Dismantling the shelf.

## 7.4 Dividing shelf

### 7.4.1 Using the dividing shelf

The shelves are prevented from being pulled out accidentally by pull out stops.

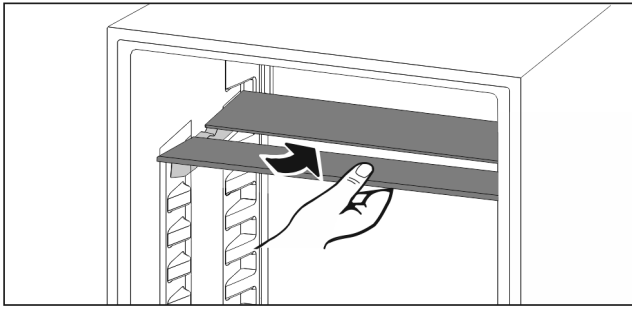

Fig. 29

- ▶ Push the dividing shelf underneath as shown.

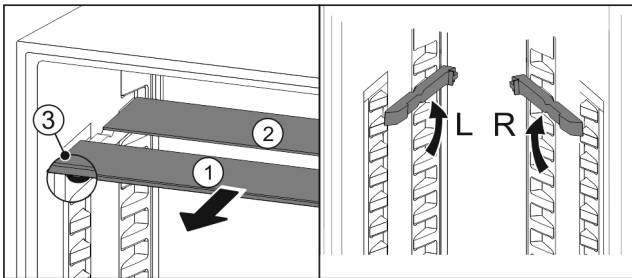

Fig. 30

### Adjusting the height:

- ▶ Pull the glass panels out Fig. 30 (1) from the front, one at a time.
- ▶ Release the support rails and click in at the height you want.
- ▶ Slide in the glass panels one at a time.
- ▷ Flat pull-out stoppers at the front, right behind the support rails.
- ▷ High pull-out stoppers at the back.

### Using both shelves:

- ▶ Hold the glass panel with one hand and pull it to the front.
- ▷ The glass panel Fig. 30 (1) and trim strip are at the front.
- ▷ The stops Fig. 30 (3) point down.

## 7.5 VarioSafe\*

The VarioSafe provides space for compact foodstuffs and packages, pots and glasses.

### 7.5.1 Using the VarioSafe

You can remove the drawer and slide it back in at 2 different heights. This is handy for storing taller items in the drawer.

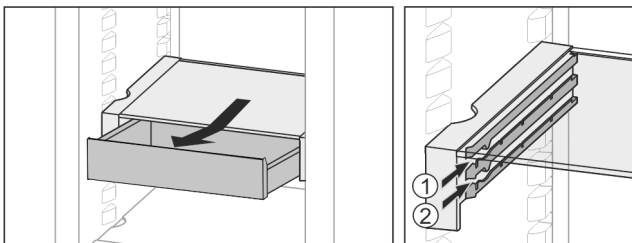

Fig. 31

- ▶ Remove the drawer.
- ▶ Slide back at the height you want Fig. 31 (1) or Fig. 31 (2).

### 7.5.2 Repositioning the VarioSafe

You can shift the height of the entire VarioSafe.

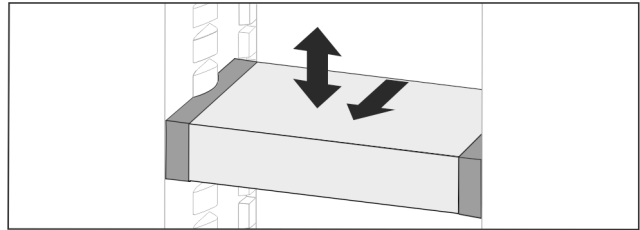

Fig. 32

- ▶ Pull forwards.
- ▷ Line up the side runner.
- ▶ Lift or lower to the height you want.
- ▶ Slide to the rear.

### 7.5.3 Removing the entire VarioSafe

You can remove VarioSafe as a whole unit.

- ▶ Pull forwards.
- ▷ Line up the side runner.

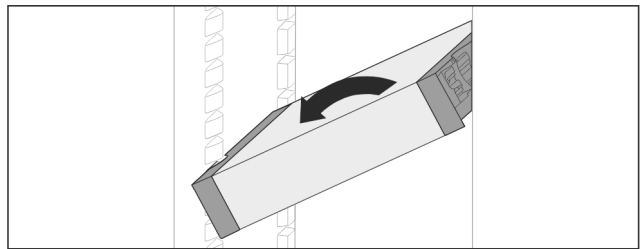

Fig. 33

- ▶ Tip to the side and pull towards you.

### 7.5.4 Disassembling the VarioSafe

You can take the VarioSafe apart for cleaning.

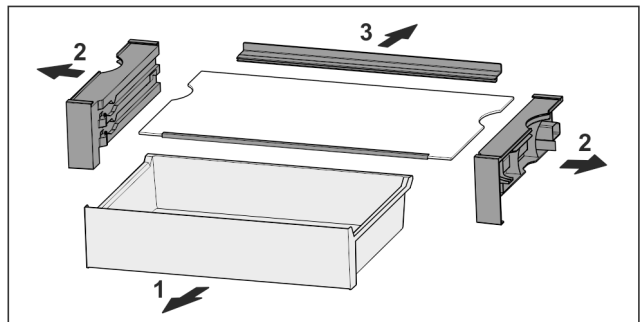

Fig. 34

- ▶ Disassembling the VarioSafe

### 7.6 Space for baking tray\*

There is space for a baking tray Fig. 1 (6) above the drawers.

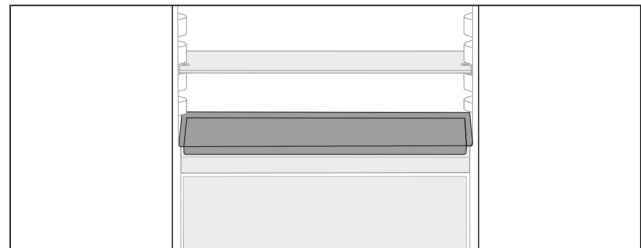

Fig. 35

Ensure that the following conditions are met:

- Max. baking tray dimensions are adhered to (see 9.1 Technical specifications).
- Baking tray is cooled to room temperature.
- The lowest door rack is set at least one position higher.

# Features

With the door open to 90°:

- ▶ Slide the baking tray onto the lower side runners.

## 7.7 Drawers

You can remove the drawers for cleaning.

The way to remove/insert the drawers varies depending on the pull-out system. Your appliance can contain various pull-out systems.

### Note

The energy consumption increases and the cooling power goes down if ventilation is not sufficient.

- ▶ Always leave the fan air vents clear on the back wall!

### 7.7.1 Drawer on appliance base or glass shelf

The drawer runs directly on the appliance base or on a glass shelf. There are no rails.

#### Removing drawer

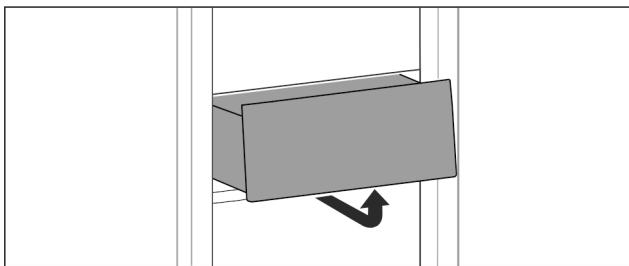

Fig. 36

- ▶ Remove drawer as shown in the illustration.

#### Inserting drawer

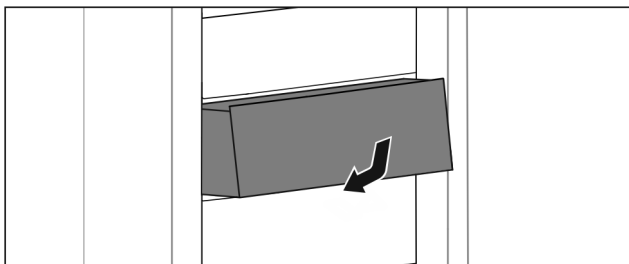

Fig. 37

- ▶ Insert drawer as shown in the illustration.

### 7.7.2 Drawer on rails

#### Removing drawer

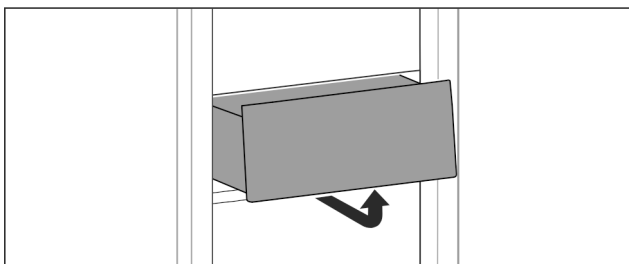

Fig. 38

- ▶ Remove drawer as shown in the illustration.

#### Inserting drawer

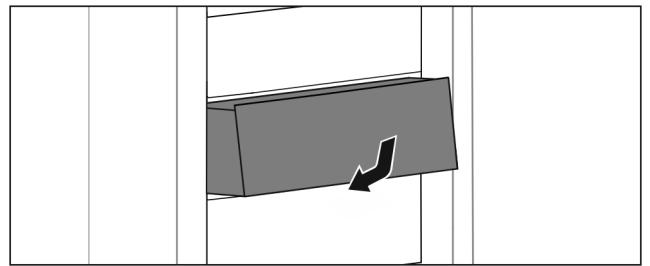

Fig. 39

- ▶ Insert drawer as shown in the illustration.

### 7.7.3 Drawer on telescopic rails

The drawer runs on extendible rails (telescopic rails). There are fully extendible telescopic rails and telescopic rails with partial pull-out. Drawers which are fully extendible can be pulled out fully from the appliance. Drawers with partial pull-out cannot be removed fully from the appliance. The system in your appliance depends on the type of appliance.

#### Partial pull-out fridge compartment

##### Removing drawer

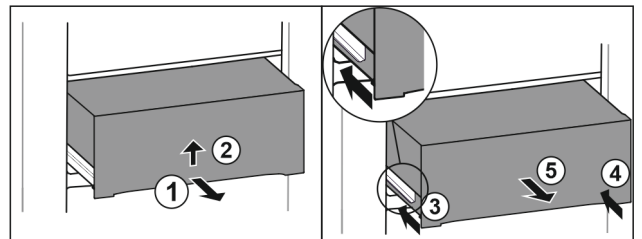

Fig. 40

- ▶ Pull out drawer half-way. Fig. 40 (1)
- ▶ Lift the drawer from the bottom. Fig. 40 (2)
- ▶ Lift and hold the drawer and at the same time pull it forwards.
- ▶ Insert left rail. Fig. 40 (3)
- ▶ Insert right rail. Fig. 40 (4)
- ▶ Remove drawer to the front. Fig. 40 (5)

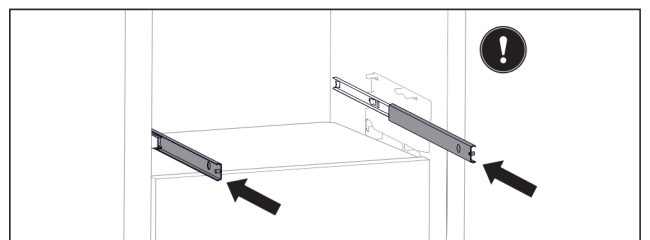

Fig. 41

If the rails are not yet fully inserted after removing the drawer:

- ▶ Push rails in completely.

##### Inserting drawer

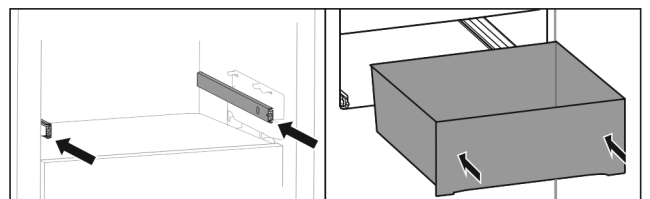

Fig. 42

- ▶ Slide rails in.
- ▶ Place drawer on rails.
- ▶ Slide in drawer to the back.

## 7.8 EasyFresh-Safe cover

You can remove the compartment cover for cleaning.

### 7.8.1 Removing the compartment cover

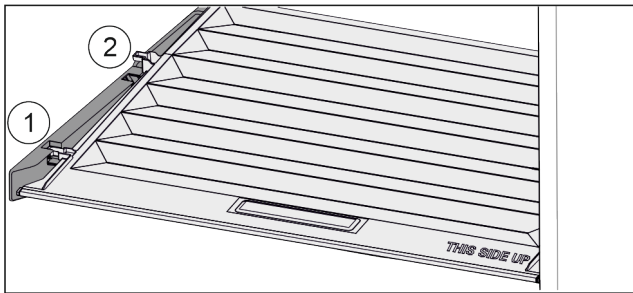

Fig. 43

When the drawers are removed:

- ▶ Pull the lid up at the front to the opening in the retaining parts Fig. 43 (1).
- ▶ Lift from the back and pull it up and out Fig. 43 (2).

### 7.8.2 Inserting the compartment cover

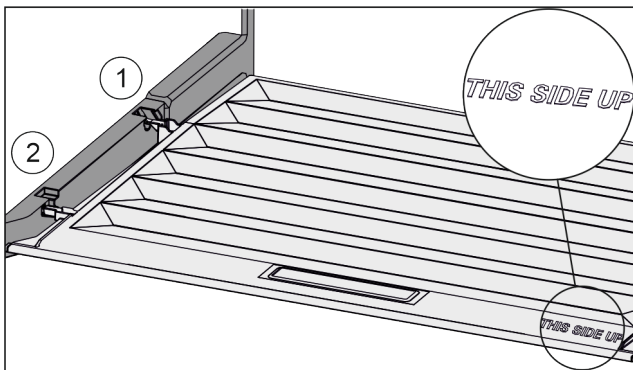

Fig. 44

If the text THIS SIDE UP points upwards:

- ▶ Insert the lip of the cover over the opening of the rear bracket Fig. 44 (1) and click into place Fig. 44 (2).
- ▶ Position the cover where you want it (see 7.9 Adjusting the moisture levels).

## 7.9 Adjusting the moisture levels

You can adjust the moisture in the drawer yourself by adjusting the compartment cover.

The compartment lid is attached to the drawer and can be hidden by a shelf or additional drawers.

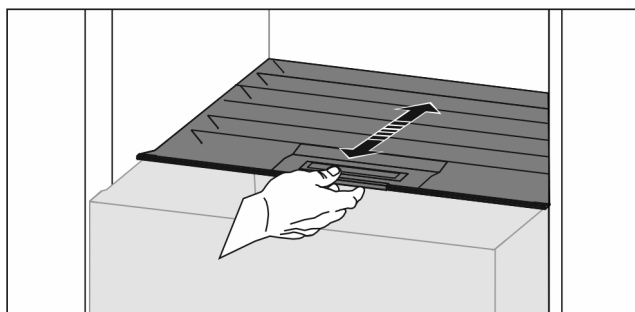

Fig. 45

### Low air humidity

- ▶ Open the drawer.
- ▶ Slide the compartment cover forwards.
- ▷ With the drawer closed: Gap between the cover and the compartment.
- ▷ The air moisture in the Safe decreases.

### High air moisture

- ▶ Open the drawer.
- ▶ Slide the cover back.
- ▷ With the drawer closed: The cover seals the compartment.
- ▷ The air moisture in the Safe increases.
- If there is too much moisture in the compartment:
  - ▶ Choose the setting "low air moisture".
- or-
- ▶ Remove any excess moisture with a cloth.

## 7.10 Butter dish

### 7.10.1 Opening/closing the butter dish

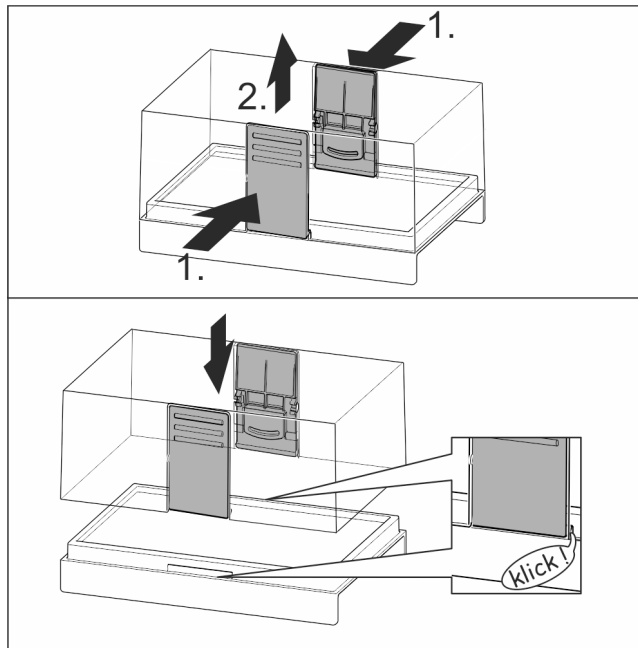

Fig. 46

### 7.10.2 Dismantling the butter dish

You can take the butter dish apart for cleaning.

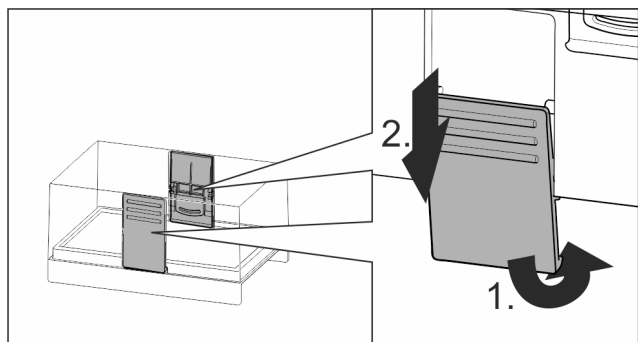

Fig. 47

- ▶ Disassembling the butter dish.

## 7.11 Egg rack

You can pull out and turn the egg rack. You can use both sides of the egg rack so you can label specifics like the purchase date.

# Maintenance

## 7.11.1 Using the egg rack

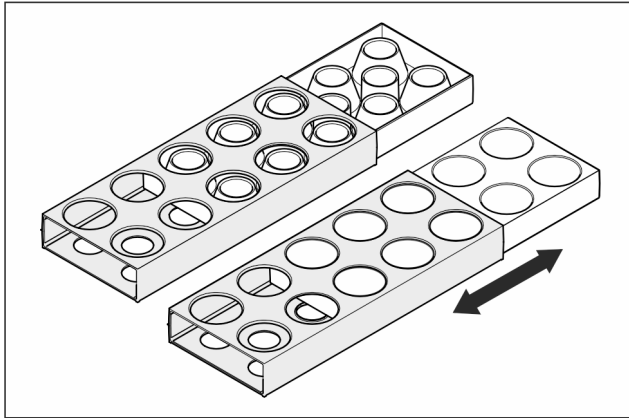

Fig. 48

- ▶ Top layer: for storing hen eggs.
- ▶ Bottom layer: for storing quail eggs.

## 7.12 Bottle holder

### 7.12.1 Using the bottle holder

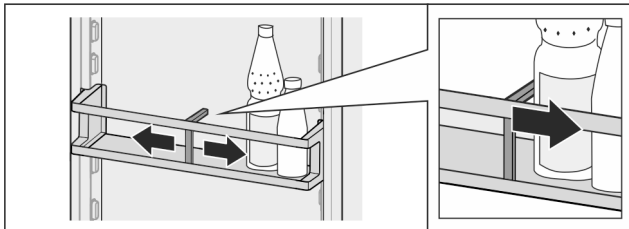

Fig. 49

- ▶ Push the bottle holder onto the bottles.
- ▷ The bottles are prevented from falling over.

### 7.12.2 Removing the bottle holder

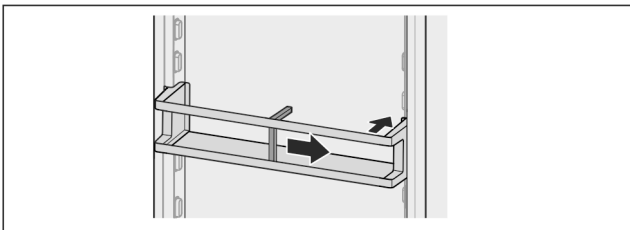

Fig. 50

- ▶ Move the bottle holder all the way to the right.
- ▶ Push the bottle holder to the back to remove.

## 7.13 Ice cube tray with cover\*

### 7.13.1 Using the ice cube tray

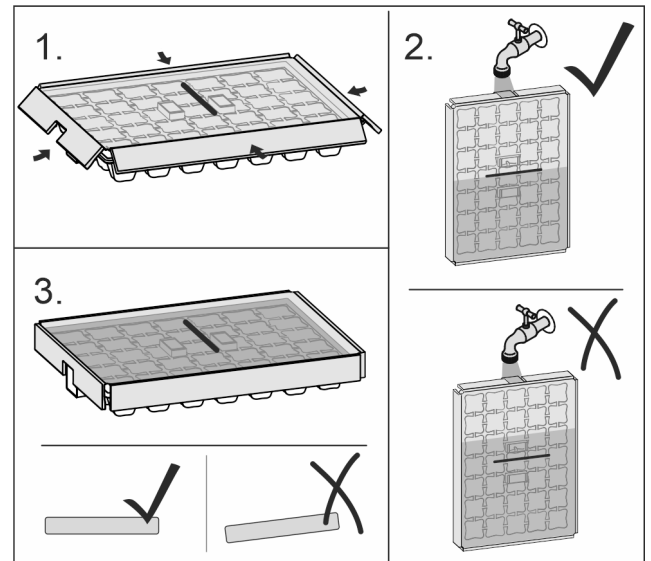

Fig. 51

When the water is frozen:

- ▶ Hold ice cube tray under hot water for a short time.
- ▶ Remove the lid.
- ▶ Gently turn the ends of the ice cube tray in opposite directions.
- ▶ Release the ice cubes.

### 7.13.2 Dismantling the ice cube tray

You can take the ice cube tray apart for cleaning.

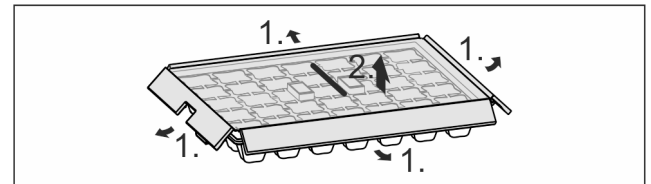

Fig. 52

- ▶ Disassembling the ice cube tray.

## 8 Maintenance

### 8.1 Disassembling / assembling pull-out systems

#### 8.1.1 Notes on disassembly

You can disassemble some of the pull-out systems for cleaning. Your appliance can contain a variety of pull-out systems.

The following pull-out systems can be disassembled or cannot be disassembled:

Pull-out system	can be disassembled / cannot be disassembled
Drawer on appliance base or glass shelf	cannot be disassembled
Drawer on rails	cannot be disassembled
Partial pull-out fridge compartment	cannot be disassembled

## 8.2 Defrosting the appliance



### WARNING

Improper defrosting of the appliance!  
Injuries and damage.

- ▶ Do not use mechanical equipment or other methods to speed up the defrosting process other than those recommended by the manufacturer.
- ▶ Do not use electrical heating or steam-cleaning appliances, naked flames or defroster sprays to defrost.
- ▶ Do not use sharp objects to remove ice.

Defrosting is performed automatically. The water from the thawing process drains through the outlet and evaporates.

Water drops or a thin layer of frost or ice can form on the back wall; this is a completely normal part of the appliance's function. This must not be removed.

A layer of frost or ice can form briefly due to the energy-optimised control of the device.

- ▶ Clean the drain opening regularly (see 8.4 Cleaning the appliance).

## 8.3 Defrosting the freezer compartment manually\*

A layer of frost or ice forms after prolonged use.

The following factors promote the formation of frost or ice:

- The appliance is opened frequently.
- Hot food is put in.
- ▶ Switch off the appliance.
- ▶ Pull out the mains plug or switch off the fuse.
- ▶ Wrap the frozen produce in newspaper or blankets and store in a cool place.

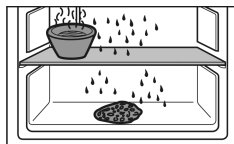

- ▶ Place a pan of hot water (not boiling) on the middle shelf.
- ▷ This speeds up the defrosting process.
- ▶ Leave the compartment and appliance door open during defrosting.
- ▶ Remove loosened pieces of ice.
- ▶ Make sure that there is no melted ice water in the cabinet.
- ▶ Soak up the melted ice water with a sponge or cloth several times as necessary.
- ▶ Clean the appliance (see 8.4 Cleaning the appliance).

## 8.4 Cleaning the appliance

### 8.4.1 Ready



### WARNING

Danger of electric shock!

- ▶ Remove the refrigerator connector or interrupt the power supply.



### WARNING

Risk of fire

- ▶ Do not damage the refrigeration circuit.

- ▶ Empty the appliance.
- ▶ Remove mains connector.

-or-

- ▶ Activate CleaningMode. (see CleaningMode)

### 8.4.2 Cleaning the interior

#### NOTICE

Improper cleaning!  
Damage to the appliance.

- ▶ Only use soft cleaning cloths and ph-neutral all-purpose cleaners.
- ▶ Do not use abrasive sponges or steel wool which may cause scratches.
- ▶ Do not use any sharp or abrasive cleaning agents, nor any that contain sand, chloride or acid.

- ▶ Plastic surfaces: clean by hand with a soft clean cloth, lukewarm water and a little detergent.
- ▶ Metal surfaces: clean by hand with a soft clean cloth, lukewarm water and a little detergent.
- ▶ Drain hole: remove deposits using a thin item (for example a cotton bud).

### 8.4.3 Clean the components

#### NOTICE

Improper cleaning!  
Damage to the appliance.

- ▶ Only use soft cleaning cloths and ph-neutral all-purpose cleaners.
- ▶ Do not use abrasive sponges or steel wool which may cause scratches.
- ▶ Do not use any sharp or abrasive cleaning agents, nor any that contain sand, chloride or acid.

#### Clean with a soft, clean cloth, lukewarm water and some detergent:

- VarioSafe\*
- EasyFresh-Safe cover
- Drawer

#### Clean with a damp cloth:

- Retractable rails
- Please note: The grease in the tracks is used for lubrication and must not be removed!

#### Wash in the dishwasher up to 60 °C:

- Door rack
- VarioBox
- Bottle rack
- Shelf
- Dividing shelf
- Holder of the dividing shelf
- Egg rack
- Butter dish
- Ice cube tray\*
- ▶ To disassemble components: see the relevant section.
- ▶ Clean the components.

### 8.4.4 After cleaning

- ▶ Wipe the appliance and the components dry.
- ▶ Connect and switch on the appliance.  
The temperature is cold enough:
- ▶ Place the food inside.
- ▶ Repeat cleaning regularly.

## 9 Customer help

### 9.1 Technical specifications

Temperature range	
Cooling	2 °C to 9 °C

Maximum freezing quantity/24 h	
Freezer compartment*	See "Freezing capacity .../24 h" on the type plate*

Maximum size baking tray*	
Width	466 mm
Depth	386 mm
Height	50 mm

## 9.2 Operating noises

The appliance makes different noises when it is on.

- At **higher temperatures** the appliance uses less energy but works for longer. It is **quieter**.
- At **lower temperatures** the food is cooled faster. It is **louder**.

Examples:

- Functions on (see 6.3 Appliance functions)
- Food recently added
- High ambient temperature
- Door open for a while

Noise	Possible cause	Type of noise
Bubbling and splashing	Coolant flowing into the cooling circuit.	Normal operating noise
Hissing	Coolant sprays into the cooling circuit.	Normal operating noise
Humming	The appliance is cooling. The volume depends on the cooling output.	Normal operating noise

Noise	Possible cause	Type of noise
Suction noises	Soft-closing door is being opened and closed.	Normal operating noise
Clicking	Components are switched on and off.	Normal switching noise
Rattling or humming	Valves or flaps are working.	Normal switching noise

Noise	Possible cause	Type of noise	Lifting
Vibration	Improper installation	Defective noise	Check the installation. Level the appliance.
Rattling	Components, items inside the appliance	Defective noise	Secure components. Leave enough space between the items.

## 9.3 Technical fault

Your appliance is designed and built to ensure it works reliably and has a long service life. In the unlikely event that a fault occurs during operation, please check whether it is due to an operating error. If so, you will be charged for the callout and repair costs even if it falls within the warranty period.

You can fix the following faults yourself.

### 9.3.1 Appliance function

Defect	Cause	Remedy
<b>The appliance is not working.</b>	→ The appliance is not switched on.	▶ Switch the appliance on.
	→ The power plug is not properly plugged into the socket.	▶ Check the power plug.
	→ There is something wrong with the power outlet fuse.	▶ Check the fuse.
	→ Power cut	▶ Keep the appliance closed. ▶ Protecting food: Lay freezer packs on top of the food or use another freezer if the power is off for a prolonged period. ▶ Do not re-freeze defrosted food,
	→ The appliance plug does not fit the appliance properly.	▶ Check the appliance plug.
<b>Temperature is not cold enough.</b>	→ The appliance door is not closed properly.	▶ Close the appliance door.
	→ Not enough ventilation.	▶ Keep ventilation grille clear, and clean it.
	→ The ambient temperature is too high.	▶ Solution: (see 1.4 Appliance range of use) .
	→ The appliance was opened too many times or for too long.	▶ Wait to see if the required temperature corrects itself. If not, contact Customer Service. (see 9.4 Customer Service)



Defect	Cause	Remedy
	→ The temperature is set incorrectly.	▶ Turn down the temperature and check after 24 hours.
	→ The appliance is too close to a heat source (oven, radiator, etc).	▶ Move the appliance or the heat source.
	→ The appliance was not correctly installed in the recess.	▶ Check if the appliance was installed correctly and that the door closes properly.
<b>The door seal is defective or needs to be replaced for another reason.</b>	→ The door seal can be replaced. It can be replaced without the need for special tools.	▶ Contact Customer Service. (see 9.4 Customer Service)
<b>The appliance builds up too much ice or condensation.</b>	→ The door seal may have slipped out of its groove.	▶ Check that the door seal is well fitted in the groove.

## 9.3.2 Features

Defect	Cause	Remedy
<b>The internal light does not come on.</b>	→ The appliance is not switched on.	▶ Switch the appliance on.
	→ The door was open for longer than 15 minutes.	▶ Interior lighting turns off automatically after approx. 15 min. with the door open.
	→ The LED interior light is faulty or the lid is damaged.	▶ Contact Customer Service. (see 9.4 Customer Service)
<b>The freezer compartment cannot be closed.*</b>	→ The lock is on when the door is open.	▶ Use the handle again.

## 9.4 Customer Service

First check whether you can rectify the fault yourself (see 9 Customer help) . If you cannot rectify the problem, contact Customer Service.

You can find the address in the enclosed brochure "Liebherr-Service" or at [home.liebherr.com/service](http://home.liebherr.com/service).



### WARNING

Unprofessional repair!  
Injuries.

- ▶ Have any repairs and action - not expressly specified - on the appliance and mains cable carried out by service personnel only. (see 8 Maintenance)
- ▶ A damaged mains cable may only be replaced by the manufacturer, the manufacturer's Customer Service or a similarly qualified person.
- ▶ In the case of appliances with an IEC connector, the change may be made by the customer.

### 9.4.1 Contacting Customer Service

Make sure that the following appliance information is available:

- Appliance name (model and index)
- Service no. (Service)
- Serial no. (S no.)
- ▶ Call up the appliance information via the display. (see Info)

-or-

- ▶ Refer to the type plate for appliance information. (see 9.5 Model plate)
- ▶ Note down the appliance information.
- ▶ Notify customer service: Report errors and the appliance information.
- ▷ This will help us to provide you with a faster, more accurate service.
- ▶ Follow further instructions from Customer Service.

## 9.5 Model plate

The model plate is behind the drawers on the inside of the appliance.

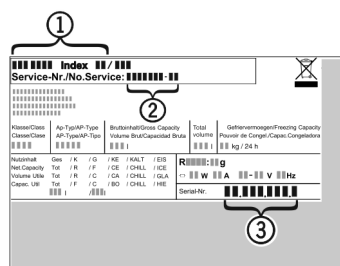

Fig. 53

- (1) Appliance description
- (2) Service no.
- (3) Serial no.

- ▶ Note the data on the model plate.

## 10 Shutting down

- ▶ Empty the appliance.

# Disposal

---

- ▶ Switch off appliance. (see Turn off appliance)
- ▶ Remove mains connector.
- ▶ Remove appliance connector if required: Remove and move from left to right at the same time.
- ▶ Clean appliance. (see 8.4 Cleaning the appliance)
- ▶ Leave the door open to avoid bad smells building up.

- ▶ Dispose of batteries, lamps and the appliance according to the above specifications.

## 11 Disposal

### 11.1 Preparing appliance for disposal



**Li-Ion**

Liebherr uses batteries in some of its appliances. In the EU, for environmental reasons, legislation obliges the end user to remove these batteries before disposing of old appliances. If your appliance contains batteries, a corresponding notice is attached.

**Lamps** If you can remove the lamps yourself without destroying them, also remove these before disposal.

- ▶ Take the appliance out of operation.
- ▶ Appliances with batteries: remove the batteries. For description, see **Maintenance** chapter.
- ▶ If possible: remove lamps without destroying them.

### 11.2 Disposing of the appliance in an environmentally friendly manner



The appliance still contains valuable materials and must be disposed of separately from unsorted municipal waste.



**Li-Ion**



**Li-Ion**

Dispose of batteries separately from the old appliance. To do this, you can return the batteries free of charge to retailers as well as recycling centres and collection centres for recyclable materials.

**Lamps** Dispose of removed lamps via the respective collection systems.

For Germany:

You can dispose of the appliance free of charge via the class 1 collection containers at the local recycling and recyclable material collection centres. When purchasing a new fridge/freezer, if the sales area > 400 m<sup>2</sup>, retailers will also take back the old appliance free of charge.



#### **WARNING**

Leaking coolant and oil!

Fire. The coolant contained in the appliance is eco-friendly, but also flammable. The oil contained in the appliance is flammable. Escaping coolant and oil can ignite if the concentration is high enough and in contact with an external heat source.

- ▶ Do not damage the pipelines of the coolant circuit and the compressor.

- ▶ Transport the appliance without damaging it.
-





[home.liebherr.com/fridge-manuals](https://home.liebherr.com/fridge-manuals)

**EN** integrated fridge

Issue date: 20230829

**Part number index: 7088259-00**

Liebherr-Hausgeräte GmbH  
Memminger Straße 77-79  
88416 Ochsenhausen  
Deutschland

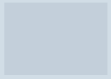

User Guide

Quality, Design and Innovation

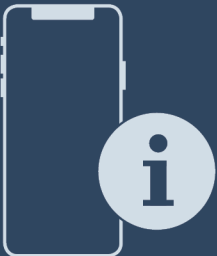



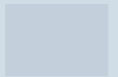
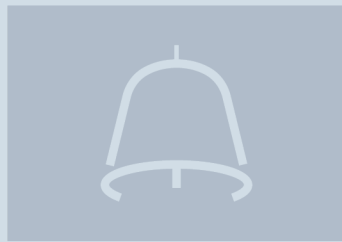









[home.liebherr.com/fridge-manuals](http://home.liebherr.com/fridge-manuals)









# LIEBHERR

# Contents

<b>1</b>	<b>Appliance at a glance.....</b>	<b>3</b>
1.1	Scope of delivery.....	3
1.2	Overview of the appliance and equipment.....	3
1.3	Appliance range of use.....	3
1.4	Conformity.....	3
1.5	EPREL database.....	3
<b>2</b>	<b>General safety instructions.....</b>	<b>4</b>
<b>3</b>	<b>Putting into operation.....</b>	<b>5</b>
3.1	Switching on appliance.....	5
3.2	Inserting the components.....	5
<b>4</b>	<b>Foods management.....</b>	<b>5</b>
4.1	Storing food.....	5
4.2	Storage times.....	6
<b>5</b>	<b>Saving energy.....</b>	<b>7</b>
<b>6</b>	<b>Controls.....</b>	<b>7</b>
6.1	Controls and displays.....	7
6.1.1	Status display.....	7
6.1.2	Navigation.....	7
6.1.3	Display symbols.....	7
6.2	Control concept.....	7
6.2.1	Activating/deactivating the function.....	7
6.2.2	Selecting function value.....	7
6.2.3	Activating/deactivating settings.....	8
6.2.4	Selecting the setting value.....	8
6.2.5	Go to the Customer menu.....	8
6.3	Functions.....	8
	Temperature.....	8
	HumidityPlus.....	8
6.4	Settings.....	9
	Language.....	9
	Connecting to the WLAN.....	9
	Entry lock.....	10
	Display brightness.....	10
	Door alarm.....	10
	Info.....	10
	SabbathMode.....	10
	CleaningMode.....	11
	BioFresh B-Value.....	11
	Reset.....	11
	Turn off appliance.....	11
6.5	Fault messages.....	11
6.5.1	Warnings.....	11
6.5.2	DemoMode.....	11
<b>7</b>	<b>Features.....</b>	<b>12</b>
7.1	Drawers.....	12
<b>8</b>	<b>Maintenance.....</b>	<b>12</b>
8.1	Disassembling / assembling pull-out systems.....	12

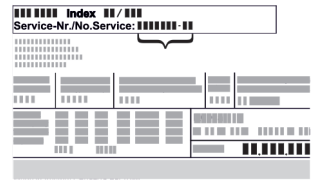
8.2	Drawer on moulded rib.....	12
8.3	Defrosting the appliance.....	13
8.4	Cleaning the appliance.....	13
<b>9</b>	<b>Customer help.....</b>	<b>14</b>
9.1	Technical specifications.....	14
9.2	Operating noises.....	14
9.3	Technical fault.....	14
9.4	Customer Services.....	15
9.5	Model plate.....	16
<b>10</b>	<b>Shutting down.....</b>	<b>16</b>
<b>11</b>	<b>Disposal.....</b>	<b>16</b>
11.1	Preparing appliance for disposal.....	16
11.2	Disposing of the appliance in an environmentally friendly manner.....	16

The manufacturer is continually working on the further development of all types and models. Please be aware that we reserve the right to make changes to the shape, equipment and technology.

Symbol	Explanation
	<b>Read instructions</b> Please read the information in these instructions carefully to understand all of the benefits of your new appliance.
	<b>Full instructions on the internet</b> You can find detailed instructions on the internet using the QR code on the front of these instruction or by entering the service number at <a href="http://home.liebherr.com/fridge-manuals">home.liebherr.com/fridge-manuals</a> . The service number can be found on the serial tag:  <i>Fig. Example illustration</i>
	<b>Check appliance</b> Check all parts for transport damage. If you have any complaints, please contact your agent or customer service.
	<b>Differences</b> These instructions apply to a range of models, so differences are possible. Sections that apply to certain models only are marked with an asterisk (*).
	<b>Instructions and results</b> Instructions are marked with a ▶. Results are marked with a ▷.
	<b>Videos</b> Videos about the appliances are available on the YouTube channels of Liebherr-Hausgeräte.

These operating instructions apply to:

SIBa	3950
------	------



## 1 Appliance at a glance

### 1.1 Scope of delivery

Check all parts for damage during transport. If you have any complaints, please contact your retailer or Customer Services (see 9.4 Customer Services).

Your new appliance comes with the following parts:

- Built-in appliance
- Features (depending on the model)
- Installation materials (depending on the model)
- "Quick Start Guide"
- "Installation Guide"
- Service Brochure

### 1.2 Overview of the appliance and equipment

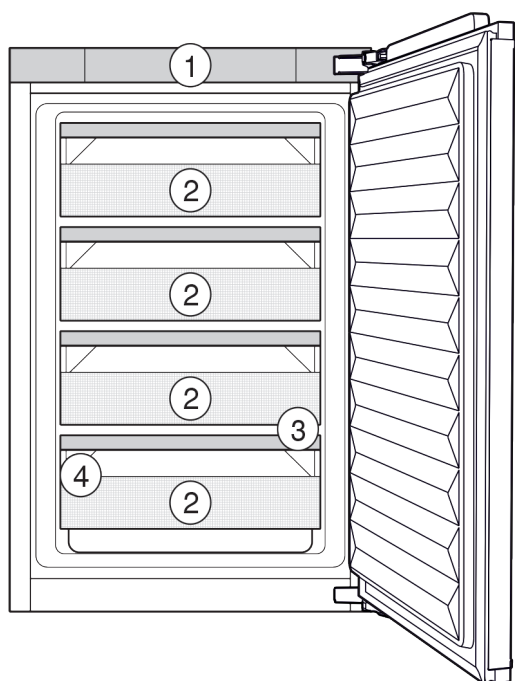

Fig. 1 Example illustration

#### Equipment

- (1)** Controls
- (2)** BioFresh-Safe
- (3)** Outlet
- (4)** Type plate

#### Note

- Shelves, drawers and baskets are arranged for optimum energy efficiency when the appliance is delivered. Changing how the shelves, for example, are inserted in the fridge compartment does not have any impact on energy consumption.

### 1.3 Appliance range of use

#### Intended use

The appliance is only suitable for cooling food products in a domestic or household-like environment. This includes, for example, use:

- in staff kitchens, bed and breakfast establishments,

- by guests in country houses, hotels, motels and other accommodation,
- for catering and similar services in the wholesale trade.

The appliance is not suitable for freezing food;

All other types of use are not permitted.

#### Foreseeable misuse

The following applications are expressly forbidden:

- Storing and refrigerating medicines, blood plasma, laboratory preparations or similar substances and products based on the Medical Device Directive 2007/47/EC
- Use in areas at risk of explosions

Misusing the appliance may lead to damage to the goods stored or they may spoil.

#### Climate classifications

Depending on the climate classification the appliance is designed to operate in restricted ambient temperatures. The climate classification applying to your appliance is printed on the rating plate.

#### Note

- Keep to the specified ambient temperatures in order to guarantee that the appliance works properly.

Climate classification	for ambient temperatures of
SN	10 °C to 32 °C
N	16 °C to 32 °C
ST	16 °C to 38 °C
T	16 °C to 43 °C

### 1.4 Conformity

The refrigerant circuit has been tested for leaks. When installed, the appliance complies with the applicable safety regulations and with the corresponding directives.

The full text of the EU Declaration of Conformity is available on the following website: [www.Liebherr.com](http://www.Liebherr.com)

The BioFresh compartment meets the requirements of a cold storage compartment as set out in DIN EN 62552:2020.

### 1.5 EPREL database

Details about energy labelling and ecodesign requirements will be available on the European product database (EPREL) from 1st March 2021. You can access the product database at the following link: <https://eprel.ec.europa.eu/> You will be asked to enter the model ID. You can find the model ID on the nameplate.

# General safety instructions

## 2 General safety instructions

Please keep these operating instructions in a safe place so you can refer back to them at any time.

If you pass the appliance on, please hand these operating instructions to the next user.

Read these operating instructions carefully before use to ensure safe and correct use of the appliance. Follow the instructions, safety instructions and warning messages included at all times. They are important for ensuring you can operate and install the appliance safely and without any problems.

### Danger for the user:

- This device can be used by children and people with impaired physical, sensory or mental abilities or with a lack of experience and knowledge provided that they are supervised or have received instruction in the safe use of this device, and about the resulting hazards. Children must not play with this appliance. Cleaning and user maintenance work must not be carried out by children without adult supervision. Children aged between 3 and 8 are allowed to load and unload the appliance. Children below the age of 3 must be kept away from the appliance unless they are under continuous adult supervision.
- The socket must be easily accessible so that the appliance can be disconnected quickly from the electricity in an emergency. It must not be located in the area behind the appliance.
- When disconnecting the appliance from the supply, always take hold of the plug. Do not pull the cable.
- In the event of a fault pull out the mains plug or deactivate the fuse.
- Do not damage the mains power cable. Do not operate the appliance with a defective mains power cable.
- Only customer service or other specially trained staff may repair or perform other operations on the appliance.
- Only install, connect and dispose of the appliance according to the instructions.
- Only use the appliance when is installed.

### Fire hazard:

- The coolant used (information on the model plate) is ecofriendly but also flammable. Any leaking coolant may ignite.
  - Do not damage the refrigerant circuit pipes.

- Do not handle ignition sources inside the appliance.
- Do not use electrical appliances inside the appliance (e.g. steam cleaners, heaters, ice cream makers, etc.).
- If the refrigerant leaks: remove any naked flames or ignition sources from the vicinity of the leakage point. Properly air the room. Inform customer services.
- Do not store explosives or sprays using combustible propellants such as butane, propane, pentane, etc. in the appliance. To identify these spray cans, look for the list of contents printed on the can, or a flame symbol. Gases possibly escaping may ignite due to electrical components.
- Keep burning candles, lamps and other items with naked flames away from the appliance so that they do not set the appliance on fire.
- Please be sure to store alcoholic drinks or other packaging containing alcohol in tightly closed containers. Any alcohol that leaks out may be ignited by electrical components.

### Danger of tipping and falling:

- Do not misuse the plinth, drawers, doors etc. as a step or for support. This applies particularly to children.

### Danger of food poisoning:

- Do not consume food which has been stored too long.

### Danger of frostbite, numbness and pain:

- Avoid prolonged skin contact with cold surfaces or refrigerated/frozen goods or take protective measures, e.g wear gloves.

### Danger of injury and damage:

- Hot steam can lead to injury. Do not use electrical heating or steam cleaning equipment, open flames or defrosting sprays to defrost.
- Do not use sharp implements to remove the ice.

### Risk of crushing:

- Do not hold the hinge when opening and closing the door. Fingers may get caught.

### Symbols on the appliance:



This symbol may be located on the compressor. It relates to the oil in the compressor and makes reference to the risk that: Swallowing or inhaling can be fatal. This advice is only relevant to recycling. There is no danger in normal operation.



This symbol is located on the compressor and indicates the danger of flammable materials. Do not remove the sticker.



This or a similar sticker may be located on the rear of the appliance. It refers to the foam-padded panels in the door and/or the housing. This advice is only relevant to recycling. Do not remove the sticker.

## Please note the warning messages and other specific advice in the other chapters:

	DANGER	indicates an immediately hazardous situation which will lead to death or serious injuries if it is not avoided.
	WARNING	indicates a hazardous situation which may lead to death or serious injuries if it is not avoided.
	CAUTION	indicates a hazardous situation which may lead to minor or moderate injuries if it is not avoided.
	NOTICE	indicates a hazardous situation which may lead to damage to property if it is not avoided.
	Note	indicates useful instructions and tips.

## 3 Putting into operation

### 3.1 Switching on appliance

Ensure that the following conditions are met:

- Appliance is installed and connected according to installation instructions.
- All adhesive strips, adhesive and protective films as well as transport safety devices in and on the appliance are removed.
- All marketing leaflets are removed from the drawers.

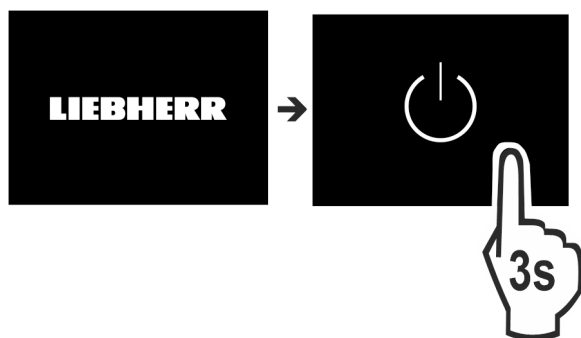

Fig. 2

- ▶ Switch on the appliance using the display.



Fig. 3

- ▶ Select the language.
- ▷ The status display appears.

### The appliance starts in DemoMode:

If the appliance starts in DemoMode, you can deactivate DemoMode within the next 5 minutes.

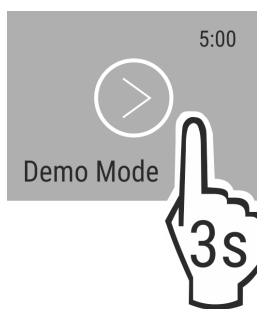

Fig. 4

- ▶ Press DemoMode for 3 seconds.
- ▷ DemoMode is deactivated.

### Note

The manufacturer recommends:

- ▶ Place the food inside: Wait for around 6 hours until the set temperature is reached.

### 3.2 Inserting the components

- ▶ Insert the supplied components to make the most of your appliance.
- ▶ Purchase and install the SmartDevice Box (see [smartdevice.liebherr.com](http://smartdevice.liebherr.com)).
- ▶ Install the SmartDevice app (see [apps.home.liebherr.com](http://apps.home.liebherr.com)).

### Note

You can purchase accessories from the [Liebherr household appliance store](http://Liebherr household appliance store) ([home.liebherr.com](http://home.liebherr.com)).

## 4 Foods management

### 4.1 Storing food



### WARNING

Risk of fire

- ▶ Do not use any electrical appliances in the food area of the appliance unless recommended by the manufacturer.

### Note

The energy consumption increases and the cooling power goes down if ventilation is not sufficient.

- ▶ Always keep air slots clear.

When storing food, always observe the following:

- Air vents on the inside rear wall are unobstructed.

# Foods management

- Air vents on the fan are unobstructed.
- Food is in sealed packaging.
- Foods that easily absorb or give off smell or taste are stored in sealed containers or covered.
- Raw meat and fish are in clean, sealed containers to prevent them coming into contact with or dripping onto other foods.
- Liquids are in sealed containers.
- Foods are not stored too closely together, as the air needs to circulate.

## Note

Failure to follow these guidelines can lead to food perishing.

### 4.1.1 BioFresh

BioFresh will extend the storage time for some fresh foods compared to traditional refrigeration.

The date indicated on the packaging always applies for foods with a minimum shelf life.

## Note

If the temperatures drop below 0 °C foods may freeze to each other.

- ▶ Do not store cold-sensitive vegetables such as cucumbers, aubergines, courgettes and cold-sensitive tropical fruit in the full-space BioFresh appliance.

For optimal storage of foods, you can regulate the humidity in the appliance using the HumidityPlus function. (see HumidityPlus)

HumidityPlus function	Storage climate	Food
activated	more humid storage climate	loose fruit and vegetables with a high moisture content
deactivated (default setting)	drier storage climate	dry or packaged foods (e.g. dairy produce, meat, fish, sausages)

### Arranging your food

When HumidityPlus is activated:

- ▶ Store loose fruit and vegetables.

When HumidityPlus is deactivated:

- ▶ Store dry or packaged foods (e.g. dairy produce, meat, fish, sausages).

## 4.2 Storage times

Refer to the specified storage times as a guide.

In the case of foods with a minimum shelf life, the date indicated on the packaging still applies.

### 4.2.1 BioFresh

## Note

You can also use the guides in the BioFresh app <https://home.liebherr.com/de/deu/service/apps/landingpage-apps-emea.html>.

Recommended storage periods with HumidityPlus deactivated		
Butter	at 1 °C	up to 90 days
Hard cheese	at 1 °C	up to 110 days
Milk	at 1 °C	up to 12 days
Sausage, cold meats	at 1 °C	up to 8 days

Recommended storage periods with HumidityPlus deactivated		
Poultry	at 1 °C	up to 6 days
Pork	at 1 °C	up to 6 days
Beef	at 1 °C	up to 6 days
Game	at 1 °C	up to 6 days

## Note

- ▶ Remember that high-protein foods perish quicker; shellfish and crustaceans do not last as long as fish, and fish does not last as long as meat.

Recommended storage periods with HumidityPlus activated		
<b>Vegetables, salads</b>		
Artichokes	at 1 °C	up to 14 days
Celery	at 1 °C	up to 28 days
Cauliflower	at 1 °C	up to 21 days
Broccoli	at 1 °C	up to 13 days
Chicory	at 1 °C	up to 27 days
Lettuce	at 1 °C	up to 19 days
Peas	at 1 °C	up to 14 days
Kale	at 1 °C	up to 14 days
Carrots	at 1 °C	up to 80 days
Garlic	at 1 °C	up to 160 days
Turnip	at 1 °C	up to 14 days
Lettuce	at 1 °C	up to 13 days
Herbs	at 1 °C	up to 13 days
Leeks	at 1 °C	up to 29 days
Mushrooms	at 1 °C	up to 7 days
Radishes	at 1 °C	up to 10 days
Brussels sprouts	at 1 °C	up to 20 days
Asparagus	at 1 °C	up to 18 days
Spinach	at 1 °C	up to 13 days
Savoy	at 1 °C	up to 20 days
<b>Fruit</b>		
Apricots	at 1 °C	up to 13 days
Apples	at 1 °C	up to 80 days
Pears	at 1 °C	up to 55 days
Blackberries	at 1 °C	up to 3 days
Dates	at 1 °C	up to 180 days
Strawberries	at 1 °C	up to 7 days
Figs	at 1 °C	up to 7 days
Blueberries	at 1 °C	up to 9 days
Raspberries	at 1 °C	up to 3 days
Currants	at 1 °C	up to 7 days
Sweet cherries	at 1 °C	up to 14 days
Kiwis	at 1 °C	up to 80 days

Recommended storage periods with HumidityPlus activated		
Peaches	at 1 °C	up to 13 days
Plums	at 1 °C	up to 20 days
Cranberries	at 1 °C	up to 60 days
Rhubarb	at 1 °C	up to 13 days
Gooseberries	at 1 °C	up to 13 days
Grapes	at 1 °C	up to 29 days



Fig. 6

## 5 Saving energy

- Pay attention to good ventilation. Do not cover ventilation holes or grids.
- Always keep the fan air slits clear.
- Do not install the appliance in direct sunlight, next to an oven, radiator or similar.
- Energy consumption depends on the installation conditions, e.g. the ambient temperature (see 1.3 Appliance range of use) . A warmer ambient temperature can increase the energy consumption.
- Open the appliance for as short a time as possible.
- The lower the temperature is set the higher the energy consumption.
- Keep all food properly packed and covered. This prevents frost from forming.
- Only take food out for as long as necessary so that it doesn't warm up too much.
- Inserting warm food: allow to cool down to room temperature first.

## 6 Controls

### 6.1 Controls and displays

The display provides a quick overview of the temperature setting and the status of functions and settings. You can control the functions and settings either by deactivating/activating them or by selecting a value.

#### 6.1.1 Status display

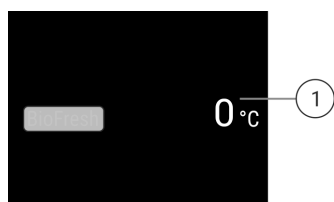

Fig. 5

**(1)** Temperature display

The Status display shows the set temperatures and is the home display. From there, you can navigate to the options and settings.

#### 6.1.2 Navigation

Navigate in the menu to access the individual functions. An audible signal sounds after confirming a function or setting. If no selection is made after 10 seconds the display switches to the Status display.

The appliance is operated by swiping and confirming in the display:

#### Back:

- Confirm your selection in the submenu. The display returns to the menu.



The display returns to the function/setting.

#### Back to Status display:

- Close and open the door.
- Wait 10 seconds. The display switches to the Status display.

### 6.1.3 Display symbols

Display symbols provide information on the current appliance status:

Symbol	Appliance status
	<b>Standby</b> The appliance or temperature zone is switched off.
	<b>Flashing number</b> Appliance is working. Temperature flashes until the set temperature is reached.
	<b>Flashing symbol</b> Appliance is working. Setting is made.

## 6.2 Control concept

### 6.2.1 Activating/deactivating the function

You can activate/deactivate the following functions:

Symbol	Function
	HumidityPlus

× When function is on, the appliance works harder. This means appliance noise when operating may be louder for a short while, and more energy will be consumed.

- ▶ Swipe left in the display until the function appears.
- ▶ Confirm selected function with a short tap.
- ▷ You hear the confirmation tone.
- ▷ Status appears in the menu.
- ▷ Function is on/off.

### 6.2.2 Selecting function value

With the following functions you can set a value in the submenu:

# Controls

Symbol	Function
	Setting the temperature Switch the appliance on/off







- ▶ Swipe left in the display until the function appears.
- ▶ Confirm selected function with a short tap.
- ▶ Select the setting value by swiping the display.

## Setting the temperature

- ▶ Confirm with a short tap.
- ▷ You hear the confirmation tone.
- ▷ The display changes to blue when it is activated.
- ▷ Display switches back to the menu.

## 6.2.3 Activating/deactivating settings

You can activate/deactivate the following settings:

Symbol	Setting
	WiFi <sup>1</sup>
	Entry lock <sup>2</sup>
	SabbathMode <sup>2</sup>
	Cleaning Mode <sup>2</sup>
	Reminders <sup>1</sup>
	Reset <sup>2</sup>
	Switch off <sup>2</sup>

- ▶ Swipe left in the display until Settings  appears.
- ▶ Tap to confirm settings.
- ▶ Swipe until you see the setting you want.

### <sup>1</sup> Activate setting (shortpress)



- ▶ Tap briefly to confirm.
- ▷ You hear the confirmation tone.
- ▷ Status appears in the menu.
- ▷ Setting is on / off.

### <sup>2</sup> Activate setting (longpress)

- ▶ Press the selection for 3 seconds to confirm.
- ▷ You hear the confirmation tone.
- ▷ Status appears in the menu.
- ▷ Display changes.

## 6.2.4 Selecting the setting value



With the following settings you can set a value in the submenu:



Symbol	Settings
	Brightness
	Door alarm
	Language

- ▶ Swipe left in the display until Settings  appears.
- ▶ Tap to confirm settings.
- ▶ Swipe until you see the setting you want.
- ▶ Tap briefly to confirm.
- ▶ Select the desired setting value by swiping the display.
- ▶ Tap briefly to confirm.
- ▷ You hear the confirmation tone.
- ▷ Status appears briefly in the submenu.
- ▷ Display switches back to the menu.

## 6.2.5 Go to the Customer menu

You can see the following settings in the Customer menu:

Symbol	Function
	BioFresh B-Value <sup>1</sup>
	Software

- ▶ Swipe left in the display until the settings  appear.
- ▶ Tap settings.
- ▷ The submenu appears.
- ▶ Swipe left in the display until the appliance information  appears.
- ▶ Press for 3 seconds.
- ▷ The input menu for a numerical code appears.
- ▶ Enter the numerical code 151.
- ▷ The customer menu appears.
- ▶ Swipe left in the display until the desired setting appears.

### <sup>1</sup> Select the value

- ▶ Confirm with a short tap.
- ▷ You hear the confirmation tone.
- ▷ Status appears briefly in the display.
- ▷ Display switches back to the menu.

### <sup>2</sup> Activate the setting

- ▶ To confirm, press the display for 3 seconds.
- ▷ You hear the confirmation tone.
- ▷ Status appears on the display.
- ▷ The symbol flashes as long as the appliance is working.

## 6.3 Functions

### Temperature

The temperature depends on the following factors:

- The amount of times the door is opened
- How long the door is open for
- The room temperature of the installation site
- The type, temperature and amount of food

BioFresh	Default setting
	BioFresh B-Value

### Setting the temperature

You can set the temperature using the **BioFresh B-Value** in the customer menu.

### HumidityPlus

This function allows you to increase the humidity in the appliance to create a moist climate inside.



Humidity-Plus function	Storage climate	Application
activated	more humid storage climate	Storing loose salad, vegetables and fruit with a high moisture content (see 4.1.1 BioFresh)
deactivated (default setting)	drier storage climate	Storing dry or packaged food (e.g. dairy produce, meat, fish, sausages) (see 4.1.1 BioFresh)

## Activating HumidityPlus

- ▶ Tap navigation arrow repeatedly until corresponding function is displayed.

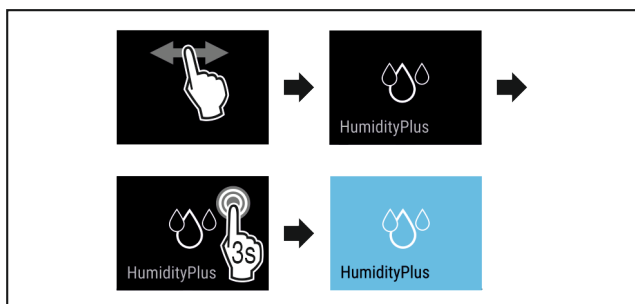

Fig. 7

- ▶ Complete steps (see Fig. 827).
- ▷ HumidityPlus function is activated.

## Deactivating HumidityPlus

- ▶ Tap navigation arrow repeatedly until corresponding function is displayed.

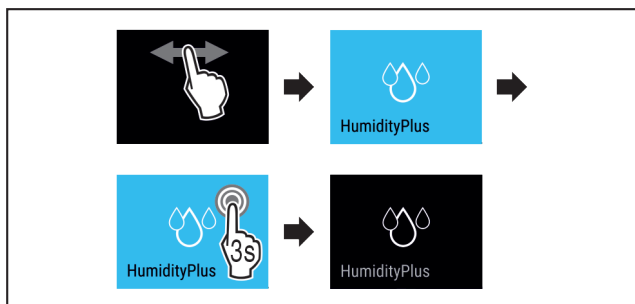

Fig. 8

- ▶ Complete steps (see Fig. 828).
- ▷ HumidityPlus function is deactivated.

## 6.4 Settings

### Language

This setting lets you choose the language of the display.

Choose from the following languages:

- German
- English
- French
- Spanish
- Italian
- Dutch
- Czech
- Polish
- Portuguese

- Russian
- Chinese

### Activating/deactivating settings

- ▶ Activating/deactivating (see 6.2 Control concept).



### Connecting to the WLAN

This setting connects the appliance to the internet. The connection is managed in the SmartDevice-Box. You can use the SmartDevice-App to add your appliance to a SmartHome-System. Use the SmartDevice-App or other compatible partner networks to enjoy advanced options and settings.

#### Note

The SmartDevice-Box is available from the [Liebherr Domestic Appliances Shop \(https://home.liebherr.com/shop/de/deu/smartdevicebox.html\)](https://home.liebherr.com/shop/de/deu/smartdevicebox.html).

You can find more information about the availability, prerequisites and the individual options on the Internet under <https://smartdevice.liebherr.com/install>.

#### Use:

- Manage the appliance with the SmartDevice-App or a compatible partner network.
- Enjoy advanced functions and settings.
- Check the current status of the appliance in the SmartDevice-App.

- The SmartDevice Box is purchased and installed (see <https://smartdevice.liebherr.com/install>).
- The SmartDevice app is installed (see <https://apps.home.liebherr.com/>).

### Setting up the connection

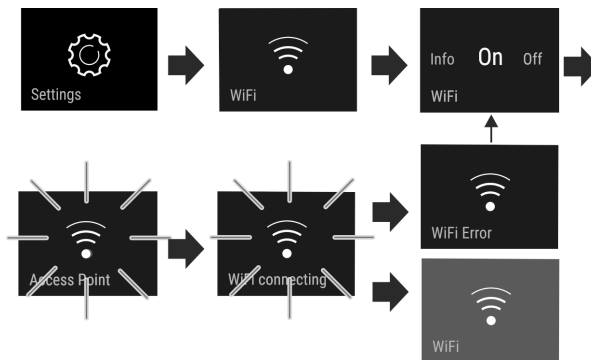

Fig. 9

- ▶ Activating the setting (see 6.2 Control concept).
- ▷ The connection is set up: Connecting appears. The symbol flashes.
- ▷ The connection is set up: WiFi appears, the display turns blue.
- ▷ The connection failed: WiFi Error appears.

### Disconnecting the appliance

- ▶ Deactivate the setting (see 6.2 Control concept).

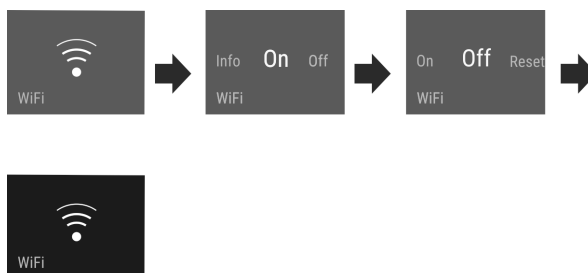



Fig. 10

# Controls



There is no connection: The symbol  is displayed constantly.



## Restoring the connection

- ▶ Restore settings (see 6.2 Control concept) .

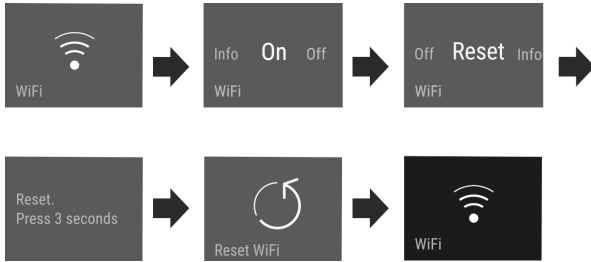

Fig. 11

- ▷ Connection and other settings are restored to factory settings.



## Entry lock

This setting prevents unintentional use of the appliance, e.g. by children.

Use:

- Avoid settings being changed unintentionally.
- Avoid the appliance being switched off unintentionally.
- Avoid the temperature being changed unintentionally.

## Activating/deactivating settings

- ▶ Activating/deactivating. (see 6.2 Control concept)

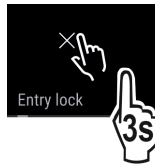

## Display brightness

Set the brightness level of the display.

You can set the following brightness levels:

- 40%
- 60%
- 80%
- 100%

## Choose the setting

- ▶ Set the level (see 6.2 Control concept) .



## Door alarm

Set the time before the door alarm (see Close the door) sounds.

The options are as follows:

- 1 min
- 2 min
- 3 min
- Off

## Choose the setting

- ▶ Set the time (see 6.5 Fault messages) .



## Info

This setting allows the appliance information to be read out as well as access to the customer menu.

It provides the following information:

- Model name
- Index
- Serial number
- Service number

## Show appliance data

- ▶ Swipe in the display until Settings  appears.
- ▶ Confirm the display.
- ▶ Swipe in the display until About appears.
- ▶ Read the appliance info.



## SabbathMode

This setting meets the religious requirements on the Sabbath and Jewish festivals. Turn on SabbathMode to switch off certain controls. This means you can use the appliance without anyone changing the settings.

You can find a list of Star-K-certified appliances at [www.star-k.org/appliances](http://www.star-k.org/appliances).

This appliance has certification from the "Institute for Science and Halacha".



## WARNING

Danger of food poisoning.

If there is a power cut while the appliance is in SabbathMode, this message is not saved. Once power is restored, the appliance continues in SabbathMode. When this mode is over no message about the power cut is displayed on the temperature display.

If there was a power cut during SabbathMode:

- ▶ Check the food for quality. Do not eat the food if it has thawed.

What the appliance does in SabbathMode:

- The Status display continuously shows SabbathMode.
- The display is locked for all functions apart from deactivating SabbathMode.
- Any functions/settings that are already on, remain active.
- The display stays bright when the door is closed.
- Reminders are disabled. The set time intervals are also paused. This function is disabled in SabbathMode.
- Reminders and warnings are not displayed. There are no acoustic signals, and the display does not show warnings or settings such as temperature alarm or door alarm.
- The internal light is off.
- The defrost cycle only works for the specified time without taking account of fridge use.
- After a power cut the appliance automatically returns to SabbathMode.

## Activating/deactivating SabbathMode

- ▶ To activate this function, swipe the display until you see Settings  in the menu and press for 1 second. The menu changes to show the available settings.
- ▶ Swipe the display until you see the SabbathMode (Menora) symbol. Press the symbol for 3 seconds.
  - ▷ The display changes colour.
  - ▷ SabbathMode is activated.

To deactivate the function, press the display for 3 seconds.

SabbathMode is deactivated.

## CleaningMode

Use this setting to easily clean the appliance. This setting refers to the fridge section [].

Use:

- Clean the fridge section by hand.

What happens on the appliance when this setting is on:

- The display permanently shows: CleaningMode.
- The fridge section is switched off.
- The internal light is on.
- Reminders and warnings are not shown. There is no acoustic signal.

### Activating/deactivating settings

- ▶ Activating/deactivating the setting (see 6.2 Control concept).
- ▷ On: fridge section is off. Light stays on.
- ▷ Off: preset temperature is restored.

After 60 min the setting turns off automatically. The appliance then continues running in normal mode.

## B5 BioFresh B-Value

When delivered, the temperature in the BioFresh compartment is set to **B5**. The status indicator on the display shows the appropriate target temperature in the full-space BioFresh compartment.

You can change this value slightly if a higher or lower ambient temperature makes it necessary. When setting the value, note:

Value	Description
B1	Lowest temperature
B1-B4	The temperature can drop to below 0 °C which means foods can easily freeze.
B5	Default temperature
B9	Highest temperature

*BioFresh B-Value*

### Selecting the setting value

- ▶ Set value in customer menu (see 6.2 Control concept).
- ▶ Check whether the appliance has reached the desired temperature range in BioFresh.

## Reset

This function resets all settings to the factory settings. All settings that you have made thus far will be reset to their original values.

### Activating the setting

- ▶ Activate (see 6.2 Control concept).

## Turn off appliance

This setting turns off the whole appliance.

### Switching off the entire appliance

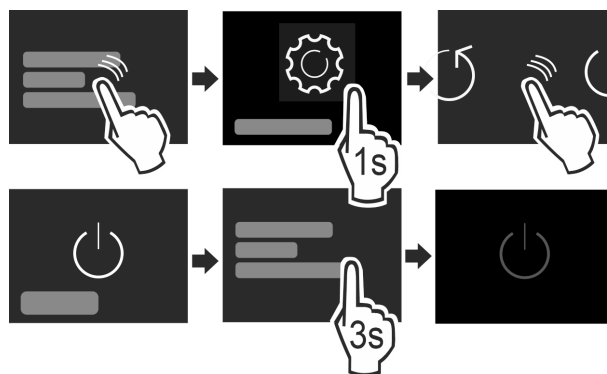

Fig. 12

- ▶ Activating/deactivating (see 6.2 Control concept).
- ▷ Off: Display goes black.

## 6.5 Fault messages

Fault messages appear in the display. There are two categories of fault message:

Category	Meaning
Message	Reminder of general procedures. You can carry out these procedures to eliminate the message.
Warning	Appears when there are malfunctions. A signal sounds in addition to the display. The signal becomes louder until you acknowledge by tapping the display. You can eliminate simple defects yourself. For more serious defects, you must contact customer service.

### 6.5.1 Warnings

#### Close the door

This message appears if the door is open for too long. You can set how long it takes for this message to appear.

- ▶ Stop alarm: Confirm the message.

-or-

- ▶ Close the door.

#### Error

This message appears if there is a fault with the appliance. An appliance component indicates a fault.

- ▶ Open the door.
- ▶ Note down the fault code.
- ▶ Confirm the message.
- ▷ The signal tone stops.
- ▷ The status display appears.
- ▶ Close the door.
- ▶ Contact customer service. (see 9.4 Customer Services)

### 6.5.2 DemoMode

If "D" appears on the display, demo mode is on. This option is designed for retailers, as it turns off all the cooling functions.

#### Stopping DemoMode

If you see the following running in the display:

- ▶ Confirm the display within the countdown.
- ▷ DemoMode is off.
- If the timer is not running:
  - ▶ Unplug the appliance.
  - ▶ Plug the appliance in again.
  - ▷ DemoMode is off.

# Features

## 7 Features

### 7.1 Drawers

You can remove the drawers for cleaning.

The way to remove/insert the drawers varies depending on the pull-out system. Your appliance can contain various pull-out systems.

#### Note

The energy consumption increases and the cooling power goes down if ventilation is not sufficient.

- ▶ Always leave the fan air vents clear on the back wall!

#### 7.1.1 Drawer on appliance base or glass shelf

The drawer runs directly on the appliance base or on a glass shelf. There are no rails.

When you remove the drawers, you can use the glass shelves below them as storage shelves.

##### Removing drawer

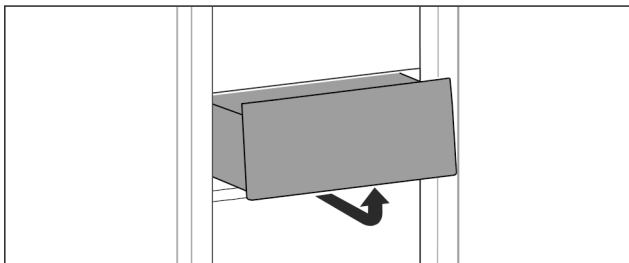

Fig. 13

- ▶ Remove drawer as shown in the illustration.

##### Inserting drawer

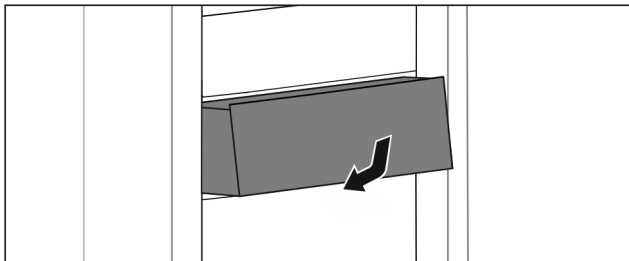

Fig. 14

- ▶ Insert drawer as shown in the illustration.

#### 7.1.2 Drawer on moulded rib

The drawer runs directly on the moulded rib. There are no rails.

##### Removing drawer

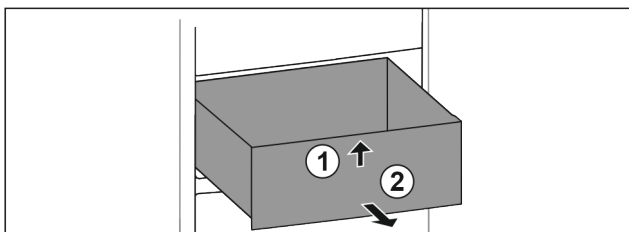

Fig. 15

- ▶ Pull out drawer as far as it will go.
- ▶ Lift up drawer at the front. Fig. 15 (1)
- ▶ Remove drawer to the front. Fig. 15 (2)

##### Inserting drawer

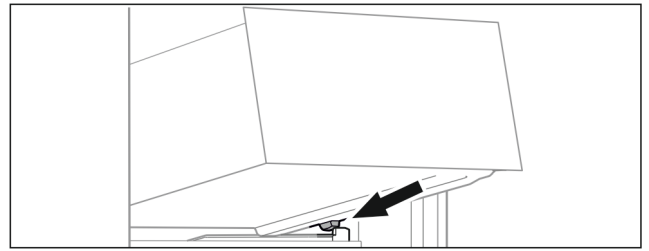

Fig. 16

- ▶ Place drawer at an angle behind the stoppers on the moulded rib. (see Fig. 836)
- ▶ Lower drawer.
- ▶ Slide in drawer to the back.

## 8 Maintenance

### 8.1 Disassembling / assembling pull-out systems

You can disassemble some of the pull-out systems for cleaning. Your appliance can contain various pull-out systems.

The following pull-out systems can be disassembled or cannot be disassembled:

Pull-out system	can be disassembled / cannot be disassembled
Drawer on appliance base or glass shelf	cannot be disassembled
Drawer on moulded rib	can be disassembled (see 8.2 Drawer on moulded rib)

#### 8.2 Drawer on moulded rib

##### 8.2.1 Disassembling pull-out system

Make sure the following prerequisites are met:

- Drawer has been removed. (see 7.1.2 Drawer on moulded rib)

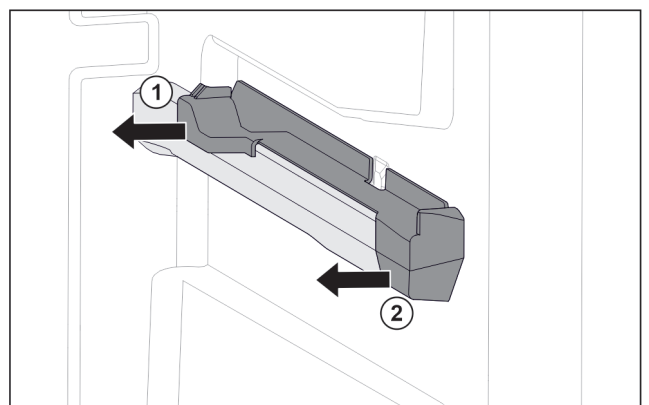

Fig. 17 Attachment on the right moulded rib

- ▶ Grab attachment at the back from below.
- ▶ Pull off attachment at the back sideways. Fig. 17 (1)
- ▶ Pull off attachment at the front sideways. Fig. 17 (2)

## 8.2.2 Installing pull-out system

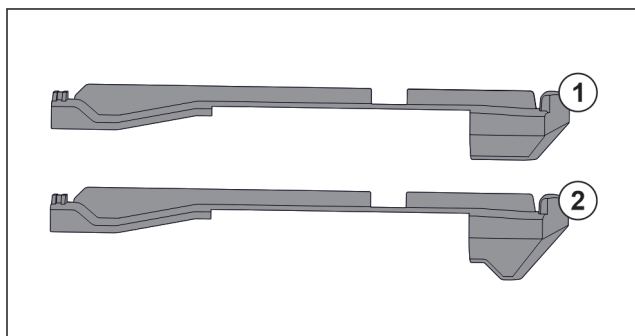

Fig. 18 Comparing attachments

There are two different attachments in the appliance. The attachment above the lowest drawer Fig. 18 (2) has a three-cornered edge. All other attachments Fig. 18 (1) have a straight edge.

- ▶ Fit attachment Fig. 18 (2) with the three-cornered edge above the lowest drawer.
- ▶ Fit attachment Fig. 18 (1) with straight edge in all other positions.

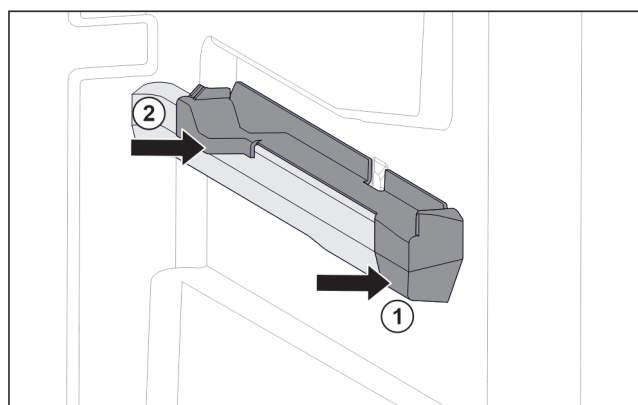

Fig. 19 Attachment on the right moulded rib

- ▶ Position attachment on moulded rib at the front. Fig. 19 (1)
- ▶ Press on attachment at the back. Fig. 19 (2)

## 8.3 Defrosting the appliance



### WARNING

Improper defrosting of the appliance!  
Injuries and damage.

- ▶ Do not use mechanical equipment or other methods to speed up the defrosting process other than those recommended by the manufacturer.
- ▶ Do not use electrical heating or steam-cleaning appliances, naked flames or defroster sprays to defrost.
- ▶ Do not use sharp objects to remove ice.

Defrosting is performed automatically. The water from the thawing process drains through the outlet and evaporates.

Water drops or a thin layer of frost or ice can form on the back wall; this is a completely normal part of the appliance's function. This must not be removed.

- ▶ Clean the drain opening regularly (see 8.4 Cleaning the appliance).

## 8.4 Cleaning the appliance

### 8.4.1 Ready



### WARNING

Danger of electric shock!

- ▶ Remove the refrigerator connector or interrupt the power supply.



### WARNING

Risk of fire

- ▶ Do not damage the refrigeration circuit.

- ▶ Empty the appliance.
- ▶ Remove mains connector.

-or-

- ▶ Activate CleaningMode. (see CleaningMode)

### 8.4.2 Cleaning the interior

#### NOTICE

Improper cleaning!

Damage to the appliance.

- ▶ Only use soft cleaning cloths and ph-neutral all-purpose cleaners.
- ▶ Do not use abrasive sponges or steel wool which may cause scratches.
- ▶ Do not use any sharp or abrasive cleaning agents, nor any that contain sand, chloride or acid.

- ▶ Plastic surfaces: clean by hand with a soft clean cloth, lukewarm water and a little detergent.
- ▶ Metal surfaces: clean by hand with a soft clean cloth, lukewarm water and a little detergent.
- ▶ Drain outlet Fig. 1 (3): remove any deposits with a thin item such as a cotton bud.

### 8.4.3 Clean the components

#### NOTICE

Improper cleaning!

Damage to the appliance.

- ▶ Only use soft cleaning cloths and ph-neutral all-purpose cleaners.
- ▶ Do not use abrasive sponges or steel wool which may cause scratches.
- ▶ Do not use any sharp or abrasive cleaning agents, nor any that contain sand, chloride or acid.

**Clean with a soft, clean cloth, lukewarm water and some detergent:**

- Drawer
- ▶ To disassemble components: see the relevant section.
- ▶ Clean the components.

### 8.4.4 After cleaning

- ▶ Wipe the appliance and the components dry.
- ▶ Connect and switch on the appliance.  
The temperature is cold enough:
- ▶ Place the food inside.
- ▶ Repeat cleaning regularly.

## 9 Customer help

### 9.1 Technical specifications

Temperature range	
BioFresh	B1 to B9

Maximum component capacity			
Features	Appliance width 550 mm (see installation instructions, appliance dimensions)	Appliance width 600 mm (see installation instructions, appliance dimensions)	Appliance width 700 mm (see installation instructions, appliance dimensions)
Drawer on glass shelf	12 kg	15 kg	--
Drawer on moulded rib	14 kg	19 kg	19 kg

Lighting	
Class <sup>1</sup>	Light source
This product contains a light source that meets energy efficiency rating G	LED

*1 The appliance may contain light sources with different energy efficiency classes. The lowest energy efficiency class is indicated.*

### 9.2 Operating noises

The appliance makes different noises when it is on.

- At **higher temperatures** the appliance uses less energy but works for longer. It is **quieter**.
- At **lower temperatures** the food is cooled faster. It is **louder**.

Examples:

- Functions on (see 6.3 Functions)
- Fan running
- Food recently added
- High ambient temperature
- Door open for a while

Noise	Possible cause	Type of noise
Bubbling and splashing	Coolant flowing into the cooling circuit.	Normal operating noise

Defect	Cause	Remedy
<b>The appliance is not working.</b>	→ The appliance is not switched on.	▶ Switch the appliance on.
	→ The power plug is not properly plugged into the socket.	▶ Check the power plug.
	→ There is something wrong with the power outlet fuse.	▶ Check the fuse.
	→ Power cut	▶ Keep the appliance closed.

Noise	Possible cause	Type of noise
Hissing	Coolant sprays into the cooling circuit.	Normal operating noise
Humming	The appliance is cooling. The volume depends on the cooling output.	Normal operating noise
Suction noises	Soft-closing door is being opened and closed.	Normal operating noise
Humming and rustling	The fan is running.	Normal operating noise
Clicking	Components are switched on and off.	Normal switching noise
Rattling or humming	Valves or flaps are working.	Normal switching noise

Noise	Possible cause	Type of noise	Lifting
Vibration	Improper installation	Defective noise	Check the installation. Level the appliance.
Rattling	Components, items inside the appliance	Defective noise	Secure components. Leave enough space between the items.

### 9.3 Technical fault

Your appliance is designed and built to ensure it works reliably and has a long service life. In the unlikely event that a fault occurs during operation, please check whether it is due to an operating error. If so, you will be charged for the callout and repair costs even if it falls within the warranty period.

You can fix the following faults yourself.

#### 9.3.1 Appliance function



Defect	Cause	Remedy
		<ul style="list-style-type: none"> <li>▶ Protecting food: Lay freezer packs on top of the food or use another freezer if the power is off for a prolonged period.</li> <li>▶ Do not re-freeze defrosted food,</li> </ul>
	→ The appliance plug does not fit the appliance properly.	▶ Check the appliance plug.
<b>Temperature is not cold enough.</b>	→ The appliance door is not closed properly.	▶ Close the appliance door.
	→ Not enough ventilation.	▶ Keep ventilation grille clear, and clean it.
	→ The ambient temperature is too high.	▶ Solution: (see 1.3 Appliance range of use) .
	→ The appliance was opened too many times or for too long.	▶ Wait to see if the required temperature corrects itself. If not, contact Customer Service (see 9.4 Customer Services) .
	→ The temperature is set incorrectly.	▶ Turn down the temperature and check after 24 hours.
	→ The appliance is too close to a heat source (oven, radiator, etc).	▶ Move the appliance or the heat source.
	→ The appliance was not correctly installed in the recess.	▶ Check if the appliance was installed correctly and that the door closes properly.
<b>The door seal is defective or needs to be replaced for another reason.</b>	→ The door seal can be replaced. It can be replaced without the need for special tools.	▶ Contact Customer Services (see 9.4 Customer Services) .
<b>The appliance builds up too much ice or condensation.</b>	→ The door seal may have slipped out of its groove.	▶ Check that the door seal is well fitted in the groove.

## 9.3.2 Features

Defect	Cause	Remedy
<b>The internal light does not come on.</b>	→ The appliance is not switched on.	▶ Switch the appliance on.
	→ The door was open for longer than 15 minutes.	▶ Interior lighting turns off automatically after approx. 15 min. with the door open.
	→ The LED interior light is faulty or the lid is damaged.	▶ Contact customer service (see 9.4 Customer Services) .

## 9.4 Customer Services

First check if you can fix the error yourself (see 9 Customer help) . If you can't, contact Customer Services.

Please refer to the enclosed "Liebherr-Service" brochure for the address.



### WARNING

Unprofessional repair!  
Injuries.

- ▶ Have any repairs and action - not expressly specified - on the appliance and mains cable carried out by service personnel only. (see 8 Maintenance)
- ▶ A damaged mains cable may only be replaced by the manufacturer, the manufacturer's Customer Service or a similarly qualified person.
- ▶ In the case of appliances with an IEC connector, the change may be made by the customer.

### 9.4.1 Contact Customer Services

Make sure you have the following appliance data at the ready:

- Appliance name (model and index)
- Service no. (Service)
- Serial no. (S no.)

▶ Look up the appliance information on the display (see Info) .

**-or-**

▶ Referring to appliance info on the nameplate (see 9.5 Model plate) .

▶ Note down the appliance information.

▶ Notify Customer Services of the following: Give us the appliance data.

▷ This will help us to provide you with a faster, more accurate service.

# Shutting down

- ▶ Follow any further instructions given by Customer Services.

## 9.5 Model plate

The model plate is behind the drawers on the inside of the appliance.

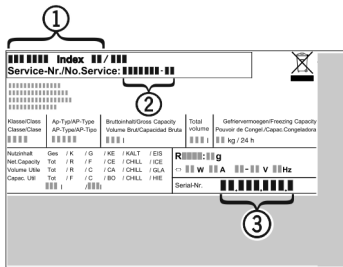

Fig. 20

- (1) Appliance description
  - (2) Service no.
  - (3) Serial no.
- ▶ Note the data on the model plate.

## 10 Shutting down

- ▶ Empty the appliance.
- ▶ Turn off the appliance (see 6.4 Settings).
- ▶ Remove mains connector.
- ▶ Remove appliance connector if required: Remove and move from left to right at the same time.
- ▶ Clean the appliance (see 8.4 Cleaning the appliance).
- ▶ Leave the door open to avoid bad smells building up.

## 11 Disposal

### 11.1 Preparing appliance for disposal



Liebherr uses batteries in some of its appliances. In the EU, for environmental reasons, legislation obliges the end user to remove these batteries before disposing of old appliances. If your appliance contains batteries, a corresponding notice is attached.

**Lamps** If you can remove the lamps yourself without destroying them, also remove these before disposal.

- ▶ Take the appliance out of operation.
- ▶ Appliances with batteries: remove the batteries. For description, see **Maintenance** chapter.
- ▶ If possible: remove lamps without destroying them.

### 11.2 Disposing of the appliance in an environmentally friendly manner



The appliance still contains valuable materials and must be disposed of separately from unsorted municipal waste.



Dispose of batteries separately from the old appliance. To do this, you can return the batteries free of charge to retailers as well as recycling centres and collection centres for recyclable materials.

Lamps

Dispose of removed lamps via the respective collection systems.

For Germany:

You can dispose of the appliance free of charge via the class 1 collection containers at the local recycling and recyclable material collection centres. When purchasing a new fridge/freezer, if the sales area > 400 m<sup>2</sup>, retailers will also take back the old appliance free of charge.



### WARNING

Leaking coolant and oil!  
Fire. The coolant contained in the appliance is eco-friendly, but also flammable. The oil contained in the appliance is flammable. Escaping coolant and oil can ignite if the concentration is high enough and in contact with an external heat source.

- ▶ Do not damage the pipelines of the coolant circuit and the compressor.
- ▶ Transport the appliance without damaging it.
- ▶ Dispose of batteries, lamps and the appliance according to the above specifications.





[home.liebherr.com/fridge-manuals](https://home.liebherr.com/fridge-manuals)

**EN** full-height BioFresh fridge

Issue date: 20221109

**Part number index: 7088274-00**

Liebherr-Hausgeräte Ochsenhausen GmbH  
Memminger Straße 77-79  
88416 Ochsenhausen  
Deutschland

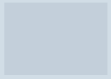

User Guide

Quality, Design and Innovation





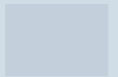















[home.liebherr.com/fridge-manuals](http://home.liebherr.com/fridge-manuals)







# LIEBHERR

# Contents

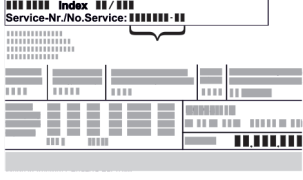

<b>1</b>	<b>Appliance at a glance.....</b>	<b>3</b>
1.1	Scope of delivery.....	3
1.2	Overview of the appliance and equipment.....	3
1.3	SmartDevice.....	4
1.4	Appliance range of use.....	4
1.5	Conformity.....	4
1.6	SVHC substances according to REACH regulation.....	4
1.7	EPREL database.....	4
<b>2</b>	<b>General safety instructions.....</b>	<b>5</b>
<b>3</b>	<b>Putting into operation.....</b>	<b>6</b>
3.1	Switching on appliance.....	6
3.2	Inserting the components.....	6
<b>4</b>	<b>Foods management.....</b>	<b>7</b>
4.1	Storing food.....	7
4.2	Storage times.....	7
<b>5</b>	<b>Saving energy.....</b>	<b>7</b>
<b>6</b>	<b>Controls.....</b>	<b>8</b>
6.1	Controls and displays.....	8
6.1.1	Status display.....	8
6.1.2	Navigation.....	8
6.1.3	Display symbols.....	8
6.2	Control concept.....	8
6.2.1	Activating/deactivating the function.....	8
6.2.2	Selecting function value.....	8
6.2.3	Activating/deactivating settings.....	9
6.2.4	Selecting the setting value.....	9
6.2.5	Go to the Customer menu.....	9
6.3	Functions.....	9
	Turn off appliance.....	9
	WiFi.....	10
	Temperature.....	10
	SuperFrost.....	10
	PartyMode.....	11
	SabbathMode.....	11
	EnergySaver.....	11
	IceMaker / MaxIce*.....	12
	Ice cubes*.....	13
	5.....	13
	TubeClean*.....	13
	Display brightness.....	13
	Door alarm.....	13
	Entry lock.....	13
	Language.....	13
	Info.....	13

	Reminder.....	14
	Reset.....	14
6.4	Fault messages.....	14
6.4.1	Warnings.....	14
6.4.2	Message.....	14
6.4.3	DemoMode.....	14
<b>7</b>	<b>Features.....</b>	<b>14</b>
7.1	Drawers.....	14
7.2	Pull-out board with IceTower*.....	16
7.3	Glass shelves*.....	17
7.4	IceMaker*.....	18
7.5	VarioSpace.....	19
7.6	Accessories.....	19
<b>8</b>	<b>Maintenance.....</b>	<b>19</b>
8.1	Disassembling / assembling pull-out systems.....	19
8.2	Defrosting the appliance.....	21
8.3	Cleaning the appliance.....	22
<b>9</b>	<b>Customer help.....</b>	<b>22</b>
9.1	Technical specifications.....	22
9.2	Operating noises.....	23
9.3	Technical fault.....	23
9.4	Customer Services.....	25
9.5	Model plate.....	25
<b>10</b>	<b>Shutting down.....</b>	<b>25</b>
<b>11</b>	<b>Disposal.....</b>	<b>25</b>
11.1	Preparing appliance for disposal.....	25
11.2	Disposing of the appliance in an environmentally friendly manner.....	25

The manufacturer is continually working on the further development of all types and models. Please be aware that we reserve the right to make changes to the shape, equipment and technology.

Symbol	Explanation
	<p><b>Read instructions</b></p> <p>Please read the information in these instructions carefully to understand all of the benefits of your new appliance.</p>
	<p><b>Full instructions on the internet</b></p> <p>You can find detailed instructions on the internet using the QR code on the front of these instruction or by entering the service number at <a href="http://home.liebherr.com/fridge-manuals">home.liebherr.com/fridge-manuals</a>.</p> <p>The service number can be found on the serial tag:</p>  <p style="text-align: right;"><i>Fig. Example illustration</i></p>
	<p><b>Check appliance</b></p> <p>Check all parts for transport damage. If you have any complaints, please contact your agent or customer service.</p>



Symbol	Explanation
	<b>Differences</b> These instructions apply to a range of models, so differences are possible. Sections that apply to certain models only are marked with an asterisk (*).
	<b>Instructions and results</b> Instructions are marked with a ▶. Results are marked with a ▷.
	<b>Videos</b> Videos about the appliances are available on the YouTube channels of Liebherr-Hausgeräte.

These operating instructions apply to:

IFN/e/d	35...39....
SIFN/e/d/e/i	39...41...45...51..

### Note

If your appliance has an N in its appliance designation, it is a NoFrost appliance.

## 1 Appliance at a glance

### 1.1 Scope of delivery

Check all parts for damage during transport. If you have any complaints, please contact your retailer or Customer Services (see 9.4 Customer Services).

Your new appliance comes with the following parts:

- Built-in appliance
- Features (depending on the model)
- Installation materials (depending on the model)
- "Quick Start Guide"
- "Installation Guide"
- Service Brochure

### 1.2 Overview of the appliance and equipment

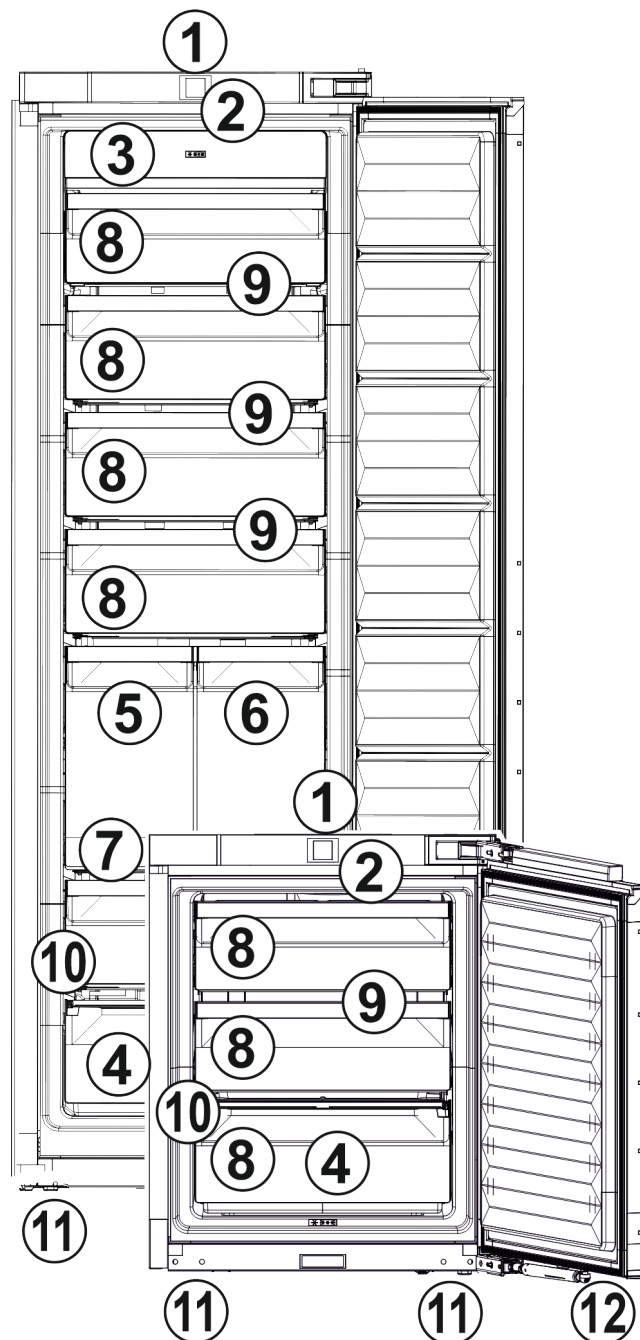

Fig. 1

- |                                    |                      |
|------------------------------------|----------------------|
| (1) Operating and control elements | (7) Pull-out board*  |
| (2) LED interior light             | (8) Drawers          |
| (3) NoFrost                        | (9) VarioSpace       |
| (4) Cold storage accumulator       | (10) Type plate      |
| (5) IceMaker*                      | (11) Adjustable feet |
| (6) IceTower*                      | (12) Soft-closing    |

### Note

▶ Shelves, drawers and baskets are arranged for optimum energy efficiency when the appliance is delivered. Changing how the shelves, for example, are inserted in the fridge compartment does not have any impact on energy consumption.

# Appliance at a glance

## 1.3 SmartDevice

SmartDevice is the networking solution for your freezer.

If your appliance SmartDevice-enabled or compatible, you can quickly and easily connect your appliance to your WiFi. With the SmartDevice app, you can operate your appliance from a mobile device. Additional functions and setting options are available in the SmartDevice SmartDevice app.

SmartDevice-enabled appliance:\* Your appliance is equipped with a SmartDeviceBox. In order to connect your appliance to the WiFi, you need to download the SmartDevice app.\*

SmartDevice-compatible appliance:\* Your appliance is compatible for use with the SmartDeviceBox. You must first purchase and install the SmartDeviceBox. In order to connect your appliance to the WiFi, you need to download the SmartDevice app.\*



More information about SmartDevice: [smartdevice.liebherr.com](http://smartdevice.liebherr.com)

Purchasing the SmartDeviceBox in the Liebherr-Hausgeräte store:\* [home.liebherr.com/shop/de/deu/smartdevicebox.html](http://home.liebherr.com/shop/de/deu/smartdevicebox.html)\*

Downloading the SmartDevice app:



After installing and configuring the SmartDevice, you can connect your appliance to the WiFi using the SmartDevice app and the WiFi appliance function (see WiFi).

### Note

You cannot use the SmartDeviceBox in the following countries: Belarus, Kazakhstan, Russia. The SmartDevice function is not available.

## 1.4 Appliance range of use

### Intended use

The appliance is only suitable for cooling food products in a domestic or household-like environment. This includes, for example, use:

- in staff kitchens, bed and breakfast establishments,
- by guests in country houses, hotels, motels and other accommodation,
- for catering and similar services in the wholesale trade.

All other types of use are not permitted.

### Foreseeable misuse

The following applications are expressly forbidden:

- Storing and refrigerating medicines, blood plasma, laboratory preparations or similar substances and products based on the Medical Device Directive 2007/47/EC
- Use in areas at risk of explosions

Misusing the appliance may lead to damage to the goods stored or they may spoil.

### Climate classifications

Depending on the climate classification the appliance is designed to operate in restricted ambient temperatures. The climate classification applying to your appliance is printed on the rating plate.

### Note

► Keep to the specified ambient temperatures in order to guarantee that the appliance works properly.

Climate classification	for ambient temperatures of
SN	10 °C to 32 °C
N	16 °C to 32 °C
ST	16 °C to 38 °C
T	16 °C to 43 °C
SN-ST	10 °C to 38 °C
SN-T	10 °C to 43 °C

## 1.5 Conformity

The refrigerant circuit has been tested for leaks. When installed, the appliance complies with the applicable safety regulations and with the corresponding directives.

For the market:\* EU The appliance complies with directive 2014/53/EU.\*

For the market:\* GB The appliance complies with Radio Equipment Regulations 2017 SI 2017 No. 1206.\*

The full text of the EU Declaration of Conformity is available on the following website: [www.liebherr.com](http://www.liebherr.com)

## 1.6 SVHC substances according to REACH regulation

You can check whether your appliance contains SVHC substances according to REACH regulation at the following link: [home.liebherr.com/de/deu/de/liebherr-erleben/nachhaltigkeit/umwelt/scip/scip.html](http://home.liebherr.com/de/deu/de/liebherr-erleben/nachhaltigkeit/umwelt/scip/scip.html)

## 1.7 EPREL database

Details about energy labelling and ecodesign requirements will be available on the European product database (EPREL) from 1st March 2021. You can access the product database at the following link: <https://eprel.ec.europa.eu/> You will be asked to enter the model ID. You can find the model ID on the nameplate.

## 2 General safety instructions

Please keep these operating instructions in a safe place so you can refer back to them at any time.

If you pass the appliance on, please hand these operating instructions to the next user.

Read these operating instructions carefully before use to ensure safe and correct use of the appliance. Follow the instructions, safety instructions and warning messages included at all times. They are important for ensuring you can operate and install the appliance safely and without any problems.

### **Danger for the user:**

- This device can be used by children and people with impaired physical, sensory or mental abilities or with a lack of experience and knowledge provided that they are supervised or have received instruction in the safe use of this device, and about the resulting hazards. Children must not play with this appliance. Cleaning and user maintenance work must not be carried out by children without adult supervision. Children aged between 3 and 8 are allowed to load and unload the appliance. Children below the age of 3 must be kept away from the appliance unless they are under continuous adult supervision.
- The socket must be easily accessible so that the appliance can be disconnected quickly from the electricity in an emergency. It must not be located in the area behind the appliance.
- When disconnecting the appliance from the supply, always take hold of the plug. Do not pull the cable.
- In the event of a fault pull out the mains plug or deactivate the fuse.
- Do not damage the mains power cable. Do not operate the appliance with a defective mains power cable.
- Only customer service or other specially trained staff may repair or perform other operations on the appliance.
- Only install, connect and dispose of the appliance according to the instructions.
- Only use the appliance when it is installed.
- The manufacturer is not liable for damage caused by a faulty fixed water connection.\*

### **Fire hazard:**

- The coolant used (information on the model plate) is ecofriendly but also flammable. Any leaking coolant may ignite.

- Do not damage the refrigerant circuit pipes.
- Do not handle ignition sources inside the appliance.
- Do not use electrical appliances inside the appliance (e.g. steam cleaners, heaters, ice cream makers, etc.).
- If the refrigerant leaks: remove any naked flames or ignition sources from the vicinity of the leakage point. Properly air the room. Inform customer services.
- Do not store explosives or sprays using combustible propellants such as butane, propane, pentane, etc. in the appliance. To identify these spray cans, look for the list of contents printed on the can, or a flame symbol. Gases possibly escaping may ignite due to electrical components.
- Keep burning candles, lamps and other items with naked flames away from the appliance so that they do not set the appliance on fire.
- Please be sure to store alcoholic drinks or other packaging containing alcohol in tightly closed containers. Any alcohol that leaks out may be ignited by electrical components.

### **Danger of tipping and falling:**

- Do not misuse the plinth, drawers, doors etc. as a step or for support. This applies particularly to children.

### **Danger of food poisoning:**

- Do not consume food which has been stored too long.

### **Danger of frostbite, numbness and pain:**

- Avoid prolonged skin contact with cold surfaces or refrigerated/frozen goods or take protective measures, e.g. wear gloves.

### **Danger of injury and damage:**

- Hot steam can lead to injury. Do not use electrical heating or steam cleaning equipment, open flames or defrosting sprays to defrost.
- Do not use sharp implements to remove the ice.

### **Risk of crushing:**

- Do not hold the hinge when opening and closing the door. Fingers may get caught.

### **Symbols on the appliance:**

# Putting into operation



This symbol may be located on the compressor. It relates to the oil in the compressor and makes reference to the risk that: Swallowing or inhaling can be fatal. This advice is only relevant to recycling. There is no danger in normal operation.



This symbol is located on the compressor and indicates the danger of flammable materials. Do not remove the sticker.



This or a similar sticker may be located on the rear of the appliance. This sticker indicates that there are vacuum insulation panels (VIP) or perlite panels in the door and/or housing. This advice is only relevant to recycling. Do not remove the sticker.

## Please note the warning messages and other specific advice in the other chapters:

	DANGER	indicates an immediately hazardous situation which will lead to death or serious injuries if it is not avoided.
	WARNING	indicates a hazardous situation which may lead to death or serious injuries if it is not avoided.
	CAUTION	indicates a hazardous situation which may lead to minor or moderate injuries if it is not avoided.
	NOTICE	indicates a hazardous situation which may lead to damage to property if it is not avoided.
	Note	indicates useful instructions and tips.

## 3 Putting into operation

### 3.1 Switching on appliance

Ensure that the following conditions are met:

- Appliance is installed and connected according to installation instructions.
- All adhesive strips, adhesive and protective films as well as transport safety devices in and on the appliance are removed.
- All marketing leaflets are removed from the drawers.

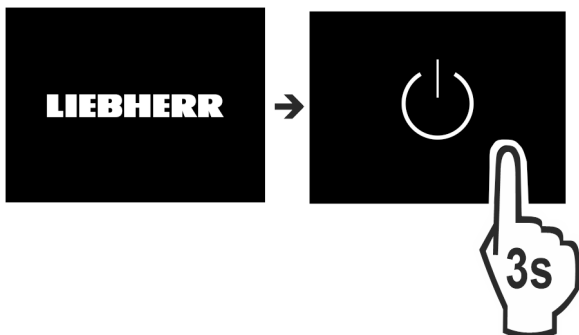

Fig. 2

- ▶ Switch on the appliance using the display.



Fig. 3

- ▶ Select the language.
- ▷ The status display appears.



#### Status light (status display):

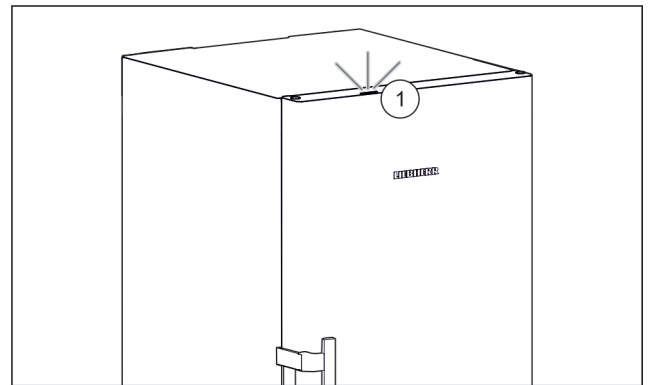

Fig. 4

When you start up the appliance, the status light Fig. 4 (1) is deactivated by default.

- ▶ Activate the status light.

#### The appliance starts in DemoMode:

If the appliance starts in DemoMode, you can deactivate DemoMode within the next 5 minutes.

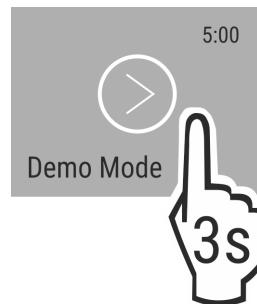

Fig. 5

- ▶ Press DemoMode for 3 seconds.
- ▷ DemoMode is deactivated.

#### Note

The manufacturer recommends:

- ▶ **Store frozen foods** at -18 °C or colder.

### 3.2 Inserting the components

#### Note

Accessories can be purchased from the Liebherr-Hausgeräte store at [home.liebherr.com/shop/de/deu/zubehor.html](http://home.liebherr.com/shop/de/deu/zubehor.html).

- ▶ Insert the supplied components to make the most of your appliance.

## 4 Foods management

### 4.1 Storing food



#### WARNING

Risk of fire

- ▶ Do not use any electrical appliances in the food area of the appliance unless recommended by the manufacturer.

#### Note

The energy consumption increases and the cooling power goes down if ventilation is not sufficient.

- ▶ Always keep air slots clear.

When storing food, always observe the following:

- Air vents on the inside rear wall are unobstructed.
- Air vents on the fan are unobstructed.
- Food is in sealed packaging.
- Raw meat and fish are in clean, sealed containers to prevent them coming into contact with or dripping onto other foods.
- Foods are not stored too closely together, as the air needs to circulate.

#### Note

Failure to follow these guidelines can lead to food perishing.

#### 4.1.1 Freezer compartment

This provides a dry, frosty storage climate at -18 °C. A frosty climate is great for storing frozen food and frozen goods for several months, making ice cubes and freezing fresh food.

#### Freezing food

You can freeze as many kilograms of fresh food within 24 hours as indicated on the nameplate (see 9.5 Model plate) under "freezing capacity ... kg/24h".

So that the food is rapidly frozen through to the core, keep to the following quantities per pack:

- Fruit, vegetables up to 1 kg
- Meat up to 2.5 kg

Before freezing goods, please make sure of the following:

- SuperFrost is activated (see 6.3 Functions) when the amount of food to freeze exceeds approx. 2 kg.
- With a small amount of frozen goods: SuperFrost is activated approx. 6 hours prior.
- With the maximum amount of frozen goods: SuperFrost is activated approx. 24 hours prior.

#### Arrange your food as follows:



#### CAUTION

Risk of injury from glass fragments!

Drink bottles and cans may explode if frozen. This applies particularly to carbonated drinks.

- ▶ Only freeze drink bottles and cans when using the *bottle timer* function.

#### For appliances smaller than 122 cm:

With a small amount of frozen goods:

- ▶ Distribute packaged groceries across all drawers.
- ▶ If possible, place groceries at the back of the drawer near the rear wall.

With a maximum amount of frozen goods:

- ▶ Distribute packaged groceries across all drawers.
- ▶ If possible, place groceries at the back of the drawer near the rear wall.

#### For appliances larger than or exactly 122 cm:

With a small amount of frozen goods:

- ▶ Distribute packaged groceries across all drawers, but do not place any groceries in the top drawer.

With a maximum amount of frozen goods:

- ▶ Distribute packaged groceries across all drawers.
- ▶ If possible, place groceries at the back of the drawer near the rear wall.

#### For all appliances:

With a maximum amount of frozen goods:

- ▶ Once SuperFrost deactivates automatically, place food into the drawer.

#### Defrost the food

- In the fridge
- In the microwave
- In the stove/oven
- At room temperature



#### WARNING

Risk of food poisoning!

- ▶ Do not re-freeze thawed food.

- ▶ Only take out the food you need at the time.
- ▶ Cook defrosted food as soon as possible.

#### Freezer tray

Use the freezer tray for berries, herbs, vegetables and other small goods without them freezing together in the process. The food keeps its shape and is easier to separate into portions later on.

You can also store the freezer packs in the freezer tray to save space.

- ▶ Spread food, unsealed, at a good distance apart, over the whole surface of the freezer tray.

## 4.2 Storage times

Refer to the specified storage times as a guide.

In the case of foods with a minimum shelf life, the date indicated on the packaging still applies.

Recommended storage period for various types of food		
Ice cream	at -18 °C	2 to 6 months
Sausages, ham	at -18 °C	2 to 3 months
Bread, baked goods	at -18 °C	2 to 6 months
Game, pork	at -18 °C	6 to 9 months
Fatty fish	at -18 °C	2 to 6 months
Lean fish	at -18 °C	6 to 8 months
Cheese	at -18 °C	2 to 6 months
Poultry, beef	at -18 °C	6 to 12 months
Vegetables, fruit	at -18 °C	6 to 12 months

## 5 Saving energy

- Pay attention to good ventilation. Do not cover ventilation holes or grids.
- Always keep the fan air slits clear.
- Do not install the appliance in direct sunlight, next to an oven, radiator or similar.
- Energy consumption depends on the installation conditions, e.g. the ambient temperature (see 1.4 Appliance range of use). A warmer ambient temperature can increase the energy consumption.

# Controls

- Open the appliance for as short a time as possible.
- The lower the temperature is set the higher the energy consumption.
- Keep all food properly packed and covered. This prevents frost from forming.
- Inserting warm food: allow to cool down to room temperature first.

## 6 Controls

### 6.1 Controls and displays

The display gives you a quick overview of the temperature setting and the status of functions and settings. Select or adjust functions by activating/deactivating or selecting a value.

#### 6.1.1 Status display

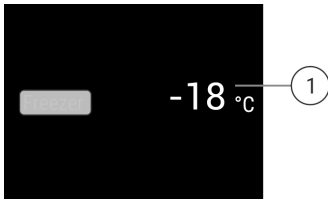



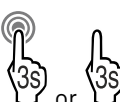

Fig. 6

(1) Temperature display

The Status display shows the set temperatures and is the home display. From there, you can navigate to the options and settings.

#### 6.1.2 Navigation



Navigate in the menu to access the individual functions. An audible signal sounds after confirming a function or setting. If no selection is made after 10 seconds, the display switches to the Status display.

Navigation	Description
	<b>Press briefly</b> Activate/deactivate function. Confirm selection. Open submenu.
	<b>Long press (3 seconds)</b> Activate/deactivate function. Increasing/decreasing bar appears in the display. Confirm selection. Reset appliance/values. Switch appliance on/off.
	<b>Swipe</b> Navigate in the menu. Search for values.

Navigation	Description
	<b>Briefly press "Back" symbol</b> Display goes back one level.
No action for 10 seconds	Display switches to the Status display.

#### 6.1.3 Display symbols





Display symbols provide information on the current appliance status:

Symbol	Appliance status
	<b>Standby</b> The appliance or temperature zone is switched off.
	<b>Flashing number</b> Appliance is working. Temperature flashes until the set temperature is reached.
	<b>Flashing symbol</b> Appliance is working. Setting is made.

## 6.2 Control concept

### 6.2.1 Activating/deactivating the function

You can activate/deactivate the following functions:



Symbol	Function
	SuperFrost <sup>x</sup>
	IceMaker and MaxIce <sup>x*</sup>
	PartyMode <sup>x</sup>
	EnergySaver

<sup>x</sup> When function is on, the appliance works harder. This means appliance noise when operating may be louder for a short while, and more energy will be consumed.

- ▶ Swipe left in the display until the function appears.
- ▶ Confirm selected function with a short tap.
- ▷ You hear the confirmation tone.
- ▷ Status appears in the menu.
- ▷ Function is on/off.

### 6.2.2 Selecting function value

With the following functions you can set a value in the submenu:

Symbol	Function
	Setting the temperature
	Switch the appliance on/off







- ▶ Swipe left in the display until the function appears.
- ▶ Confirm selected function with a short tap.



- ▶ Select the setting value by swiping the display.
- ▶ Press briefly to confirm the selected value.

## 6.2.3 Activating/deactivating settings

You can activate/deactivate the following settings:

Symbol	Setting
	WiFi <sup>1</sup>
	Entry lock <sup>2</sup>
	Status light (status display)
	SabbathMode <sup>2</sup>
	Reminders <sup>1</sup>
	Reset <sup>2</sup>
	Switch off <sup>2</sup>

- ▶ Swipe left in the display until Settings  appears.
- ▶ Tap to confirm settings.
- ▶ Swipe until you see the setting you want.

### <sup>1</sup> Activate setting (shortpress)



- ▶ Tap briefly to confirm.
- ▷ You hear the confirmation tone.
- ▷ Status appears in the menu.
- ▷ Setting is on / off.

### <sup>2</sup> Activate setting (longpress)

- ▶ Press the selection for 3 seconds to confirm.
- ▷ You hear the confirmation tone.
- ▷ Status appears in the menu.
- ▷ Display changes.

## 6.2.4 Selecting the setting value



With the following settings you can set a value in the submenu:



Symbol	Settings
	Brightness
	Door alarm
	Language

- ▶ Swipe left in the display until Settings  appears.
- ▶ Tap to confirm settings.
- ▶ Swipe until you see the setting you want.
- ▶ Tap briefly to confirm.
- ▶ Select the desired setting value by swiping the display.
- ▶ Tap briefly to confirm.
- ▷ You hear the confirmation tone.
- ▷ Status appears briefly in the submenu.
- ▷ Display switches back to the menu.

## 6.2.5 Go to the Customer menu

You can see the following settings in the Customer menu:

Symbol	Function
 *	TubeClean <sup>2*</sup>
 *	Ice cubes <sup>1*</sup>
	Software

- ▶ Swipe left in the display until the settings  appear.
- ▶ Tap settings.
- ▷ The submenu appears.
- ▶ Swipe left in the display until the appliance information  appears.
- ▶ Press for 3 seconds.
- ▷ The input menu for a numerical code appears.
- ▶ Enter the numerical code 151.
- ▷ The customer menu appears.
- ▶ Swipe left in the display until the desired setting appears.

### <sup>1</sup> Select the value

- ▶ Confirm with a short tap.
- ▷ You hear the confirmation tone.
- ▷ Status appears briefly in the display.
- ▷ Display switches back to the menu.

### <sup>2</sup> Activate the setting

- ▶ To confirm, press the display for 3 seconds.
- ▷ You hear the confirmation tone.
- ▷ Status appears on the display.
- ▷ The symbol flashes as long as the appliance is working.

## 6.3 Functions

### Turn off appliance

This setting turns off the whole appliance.

#### Switching off the entire appliance

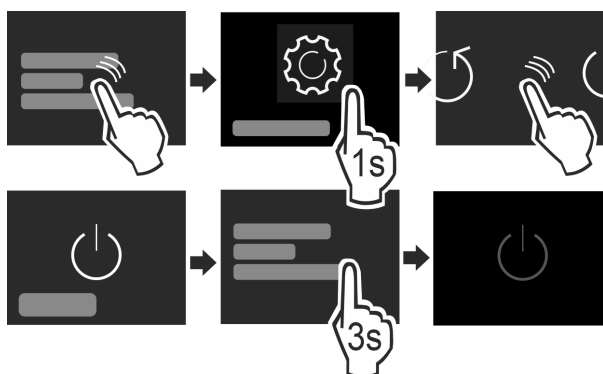

Fig. 7

- ▶ Turning off the IceMaker.\*
- ▶ Activating/deactivating (see 6.2 Control concept).
- ▷ Off: Display goes black.

# Controls



## WiFi

Use this function to connect your appliance to the WiFi. You can then operate it via the SmartDevice app on a mobile device. You can also use this function to disconnect or reset the WiFi connection. To connect your appliance to the WiFi, you need the SmartDeviceBox. For more information about the SmartDeviceBox and how to use the SmartDevice app: (see 1.3 SmartDevice)

### Note

You cannot use the SmartDeviceBox in the following countries: Belarus, Kazakhstan, Russia. The SmartDevice function is not available.

### Establishing a WiFi connection

Make sure that the following requirements are fulfilled:

- You have purchased and inserted a SmartDeviceBox. (see 1.3 SmartDevice) \*
- You have installed the SmartDevice app (see [apps.home.liebherr.com](https://apps.home.liebherr.com)).

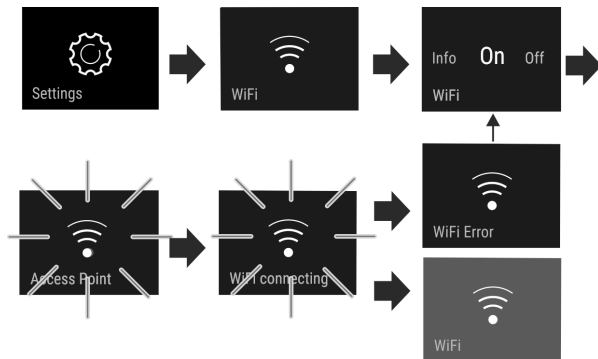

Fig. 8

- ▶ Activate the setting. (see 6.2 Control concept)
- ▷ Connection is established: Connecting appears. The symbol flashes.
- ▷ Connection is established: WiFi appears, the display turns blue.
- ▷ Connection failed: WiFi Error appears.

### Disconnecting from the WiFi

- ▶ Deactivate the setting. (see 6.2 Control concept)

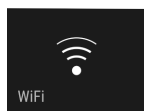
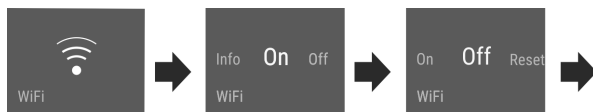

Fig. 9

- ▷ There is no connection: Symbol is permanently visible.

### Resetting the WiFi connection

- ▶ Reset settings. (see 6.2 Control concept)

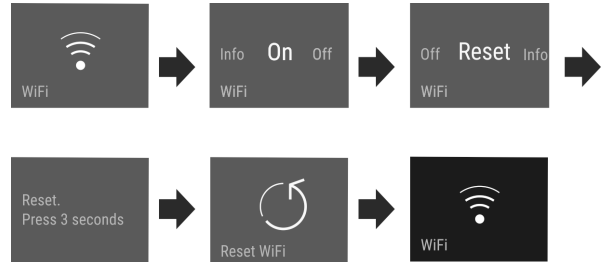

Fig. 10

- ▷ The connection and other settings are reset to the factory settings.

## -18 °C Temperature

The temperature depends on the following factors:

- The amount of times the door is opened
- How long the door is open for
- The room temperature of the installation site
- The type, temperature and amount of food

Freezer compartment	Recommended setting
-18 °C	-18 °C

### Setting temperature

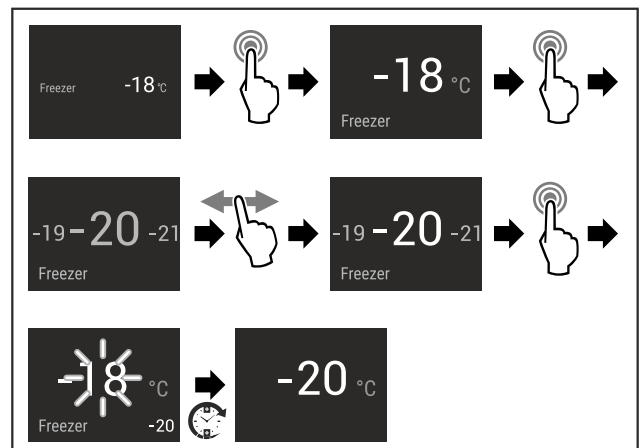

Fig. 11

- ▶ Complete the steps.
- ▷ Temperature is set.

## \* SuperFrost

This function selects the lowest freezing temperature. This gives you colder storage temperatures.

Use:

- For storing more than 2 kg fresh food every day.
- Freezing fresh food quickly to the core.
- Increasing the cold reserves in the stored goods before defrosting the appliance.

### Activating/deactivating the function

With a small amount to freeze:

- ▶ Activate 6 hours before use.
- With a maximum amount to freeze:
- ▶ Activate 24 hours before use.
- ▶ Activating/deactivating (see 6.2 Control concept) .

-or-

- ▶ Activate/deactivate using the SmartDevice app.\*

The function automatically turns off. The appliance goes back to normal mode. The temperature adjusts itself to the set level.

## PartyMode

This option offers an assortment of special functions and settings that are useful if you are having a party.

The following functions are on:

- SuperFrost
- IceMaker and MaxIce\*

All the functions can be adjusted flexibly and separately. Changes are discarded when the function turns off.

### Activating/deactivating the function

- ▶ Activating/deactivating (see 6.2 Control concept) .
- ▷ On: All functions are activated at the same time.
- ▷ Deactivated: Previously set temperatures are restored.

After 24 hours the function turns off automatically.

## SabbathMode

With this function you can activate or deactivate the SabbathMode. If you activate this function, some electronic functions will be switched off. This allows your appliance to meet religious requirements on Jewish holidays such as the Sabbath and comply with STAR-K Kosher certification.

Appliance status with active SabbathMode
The status display continuously shows SabbathMode.
All functions in the display except the <b>Deactivate SabbathMode function</b> are locked.
Active functions remain active.
The display stays lit when you close the door.
The interior lighting is off.
Reminders are disabled. The set time intervals are paused.
Reminders and warnings are not displayed.
There is no door alarm.
There is no temperature alarm.
The IceMaker is out of operation.*
The defrost cycle only works for the specified time without taking account of appliance use.
After a power failure, the appliance returns to SabbathMode.

*Appliance status*

### Note

This appliance has certification from the "Institute for Science and Halacha". ([www.machonhalacha.co.il](http://www.machonhalacha.co.il))

You can find a list of STAR-K-certified appliances at [www.star-k.org/appliances](http://www.star-k.org/appliances).

## Activating SabbathMode

### WARNING

Danger of food poisoning from spoiled food!  
If you have SabbathMode activated and a power failure occurs, no message appears in the status display about the power failure. Once the power is restored, the appliance continues to operate in SabbathMode. The power failure may mean that food spoils and the consumption of this food could lead to food poisoning.

After a power failure:

- ▶ Do not consume food that was frozen and has thawed out.

- ▶ Call up the settings menu. (see 6.2 Control concept)
- ▶ Swipe left or right until corresponding function is displayed.

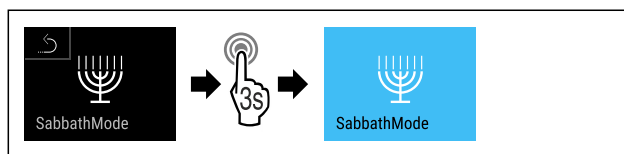

Fig. 12

- ▶ Complete the steps (see Fig. 268) .
- ▷ SabbathMode is activated.
- ▷ Status display continuously shows SabbathMode.

### Deactivating SabbathMode

- ▶ Call up the settings menu. (see 6.2 Control concept)
- ▶ Swipe left or right until corresponding function is displayed.

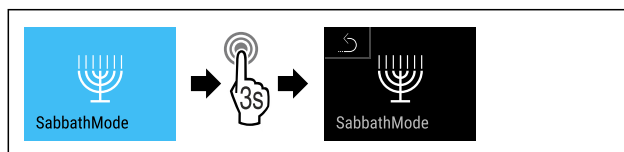

Fig. 13

- ▶ Complete the steps (see Fig. 269) .
- ▷ SabbathMode is deactivated.

## EnergySaver

This function activates or deactivates the energy-saving mode. When you activate this function, the energy consumption decreases and the temperature increases by 2 °C in the appliance. The food remains fresh, but the shelf life is shortened.

Temperature zone	Recommended setting	Temperature when EnergySaver activated
-18 °C	-18 °C	-16 °C

*Temperatures*

### Activating EnergySaver

- ▶ Swipe left or right until corresponding function is displayed.

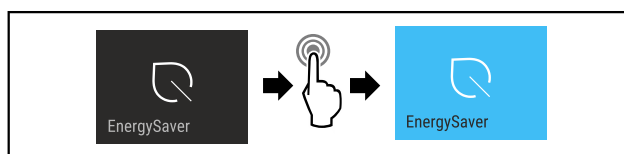

Fig. 14

- ▶ Complete the steps (see Fig. 270) .
- ▷ Energy-saving mode is activated.

# Controls

## Deactivating EnergySaver

- ▶ Swipe left or right until corresponding function is displayed.

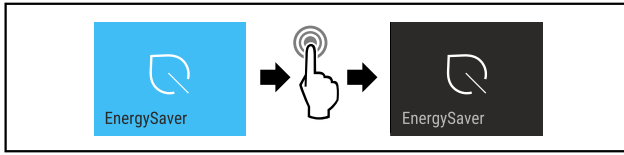

Fig. 15

- ▶ Complete the steps (see Fig. 271) .
- ▷ Energy-saving mode is deactivated.



## IceMaker / MaxIce\*

You can activate or deactivate ice cube production with the IceMaker function. Use the MaxIce function to increase the number of ice cubes in the IceMaker.

More information on the number of ice cubes:	(see 9.1 Technical specifications)
More information on the size of the ice cubes:	(see Ice cubes*)
More information on cleaning the lines of the IceMaker:	(see TubeClean*)

## Activating IceMaker

Make sure that the following requirements are fulfilled:

- The water supply is established at the fixed water connection. See installation instructions.\*
- IceMaker is put into operation. (see 7.4 IceMaker\*)
- ▶ Swipe left or right until corresponding function is displayed.

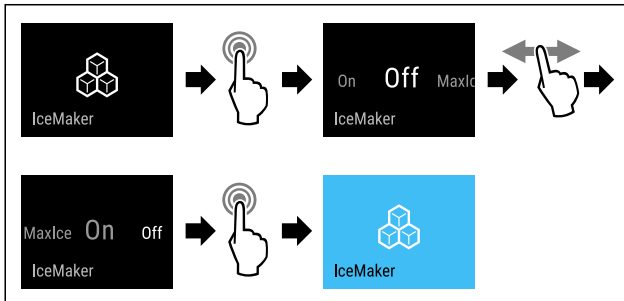

Fig. 16

- ▶ Complete the steps (see Fig. 272) .

-or-

- ▶ Activate with the SmartDevice app.

- ▷ IceMaker is activated. It can take up to 24 hours for the IceMaker to produce the first ice cubes.

## Activating the IceMaker with MaxIce

If you have not activated the IceMaker function before, make sure that the following requirements are met:

- The water supply is established at the fixed water connection. See installation instructions.\*
- IceMaker is put into operation. (see 7.4 IceMaker\*)
- ▶ Swipe left or right until corresponding function is displayed.

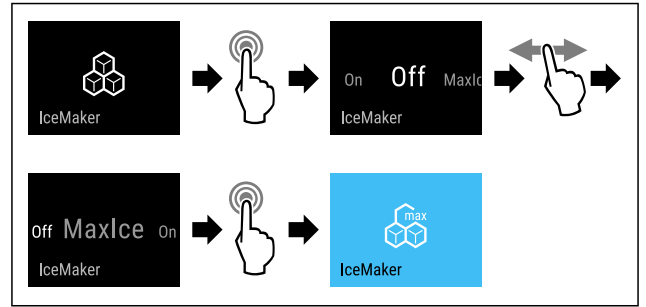

Fig. 17

- ▶ Complete the steps (see Fig. 273) .

-or-

- ▶ Activate with the SmartDevice app.

- ▷ The IceMaker is activated with MaxIce.

## Changing between the IceMaker and MaxIce

If you have activated the IceMaker and would like to change to MaxIce:

- ▶ Swipe left or right until corresponding function is displayed.

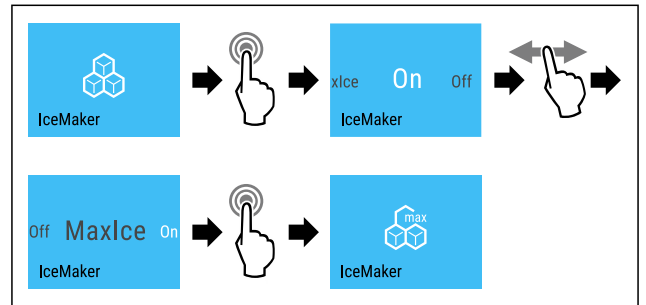

Fig. 18

- ▶ Complete the steps (see Fig. 274) .

- ▷ The IceMaker is activated with MaxIce.

If you have activated MaxIce and would like to change to the IceMaker:

- ▶ Swipe left or right until corresponding function is displayed.

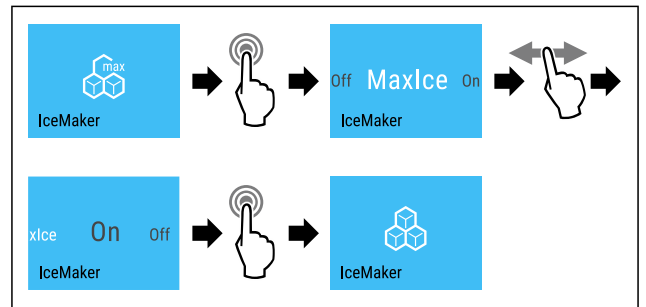

Fig. 19

- ▶ Complete the steps (see Fig. 275) .

- ▷ IceMaker is activated.

- ▷ MaxIce is deactivated.

## Deactivating the IceMaker / MaxIce

- ▶ Swipe left or right until corresponding function is displayed.

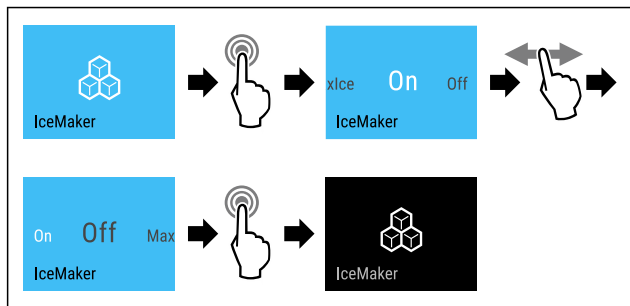

Fig. 20 Example illustration of the active IceMaker function

- ▶ Complete the steps (see Fig. 276).

**-or-**

- ▶ Deactivate with the SmartDevice app.
- ▷ IceMaker and MaxIce are deactivated.
- ▷ If ice cubes are currently being made, the system completes the process.
- ▷ The IceMaker goes off automatically.

**5**

## Ice cubes\*

Set the ice cube size.\*

### Choose the setting\*

- ▶ Set the size in the Customer menu (see 6.2 Control concept).



## TubeClean\*

This setting cleans the IceMaker pipes.\*

Ensure that the following conditions are met:\*

- IceMaker cleaning is ready (see 8.3.4 Cleaning the IceMaker\*).

### Activating the setting\*

- ▶ Activate the setting in the Customer menu (see 6.2 Control concept).
- ▷ The rinse process is ready (max. 60 min.): Symbol flashes.
- ▷ Water pipes are rinsed: Symbol flashes.
- ▷ Rinsing process is complete: Function turns off automatically.



## Display brightness

Set the brightness level of the display.

You can set the following brightness levels:

- 40%
- 60%
- 80%
- 100%

### Choose the setting

- ▶ Set the level (see 6.2 Control concept).



## Door alarm

Set the time before the door alarm (see Close the door) sounds.

The options are as follows:

- 1 min
- 2 min

- 3 min
- Off

### Choose the setting

- ▶ Set the time (see 6.4 Fault messages).



## Entry lock

This setting prevents unintentional use of the appliance, e.g. by children.

Use:

- Avoid settings being changed unintentionally.
- Avoid the appliance being switched off unintentionally.
- Avoid the temperature being changed unintentionally.

### Activating/deactivating settings

- ▶ Activating/deactivating. (see 6.2 Control concept)



## Language

This setting lets you choose the language of the display.

Choose from the following languages:

- German
- English
- French
- Spanish
- Italian
- Dutch
- Czech
- Polish
- Portuguese
- Russian
- Chinese

### Activating/deactivating settings

- ▶ Activating/deactivating (see 6.2 Control concept).



## Info

This setting allows the appliance information to be read out as well as access to the customer menu.

It provides the following information:

- Model name
- Index
- Serial number
- Service number

### Show appliance data

- ▶ Swipe in the display until Settings  appears.
- ▶ Confirm the display.
- ▶ Swipe in the display until About appears.
- ▶ Read the appliance info.

# Features



## Reminder

Reminders are given out acoustically by a beep and visually by a symbol in the display. The signal gets louder until the alert stops.

### Activating the setting

- ▶ Activating/deactivating (see 6.2 Control concept) .



## Reset

This function resets all settings to the factory settings. All settings that you have made thus far will be reset to their original values.

### Activating the setting

- ▶ Activate (see 6.2 Control concept) .

## 6.4 Fault messages

Fault messages appear in the display. There are two categories of fault message:

Category	Meaning
Message	Reminder of general procedures. You can carry out these procedures to eliminate the message.
Warning	Appears when there are malfunctions. A signal sounds in addition to the display. The signal becomes louder until you acknowledge by tapping the display. You can eliminate simple defects yourself. For more serious defects, you must contact customer service.

### 6.4.1 Warnings



## Close the door

This message appears if the door is open for too long.

You can set how long it takes for this message to appear .

- ▶ Stop alarm: Confirm the message.

-or-

- ▶ Close the door.



## Power cut

This message appears if the freezer temperature increased due to a power cut. After the power is restored, the appliance continues to work at the set temperature.

- ▶ Stop alarm: Confirm the message.
- ▷ Temperature alert appears (see Temperature alarm) .



## Temperature alarm

This message appears if the temperature does not match the set temperature.

Variations in temperature could be because:

- Hot, fresh food was inserted.
- Too much warm room air flowed in when rearranging and removing food.
- The power was cut off for a while.
- The appliance is faulty.

When the fault is eliminated the appliance continues to work at the set temperature.

- ▶ Confirm the display.
- ▷ The highest temperature is shown.
- ▶ Confirm display again.

- ▷ The status display is displayed.
- ▷ The current temperature is shown.



## Error

This message appears if there is a fault with the appliance. An appliance component indicates a fault.

- ▶ Open the door.
- ▶ Note down the fault code.
- ▶ Confirm the message.
- ▷ The signal tone stops.
- ▷ The status display appears.
- ▶ Close the door.
- ▶ Contact customer service. (see 9.4 Customer Services)

### 6.4.2 Message



## Insert IceMaker drawer\*

This message appears if the IceMaker drawer is open.

- ▶ Push in the IceMaker drawer.
- ▷ The message disappears.
- ▷ The IceMaker produces ice cubes.

### 6.4.3 DemoMode

If "D" appears on the display, demo mode is on. This option is designed for retailers, as it turns off all the cooling functions.

#### Stopping DemoMode

If you see the following running in the display:

- ▶ Confirm the display within the countdown.
- ▷ DemoMode is off.
- If the timer is not running:
  - ▶ Unplug the appliance.
  - ▶ Plug the appliance in again.
- ▷ DemoMode is off.

## 7 Features

### 7.1 Drawers

You can remove the drawers for cleaning.

You can remove the drawers to use VarioSpace.

The way to remove/insert the drawers varies depending on the pull-out system. Your appliance can contain various pull-out systems.

#### Note

The energy consumption increases and the cooling power goes down if ventilation is not sufficient.

- ▶ Leave the bottom drawer in the appliance!
- ▶ Always leave the fan air vents clear on the back wall!

#### 7.1.1 Drawer on appliance base or glass shelf

The drawer runs directly on the appliance base or on a glass shelf. There are no rails.

When you remove the drawers, you can use the glass shelves below them as storage shelves.\*

## Removing drawer

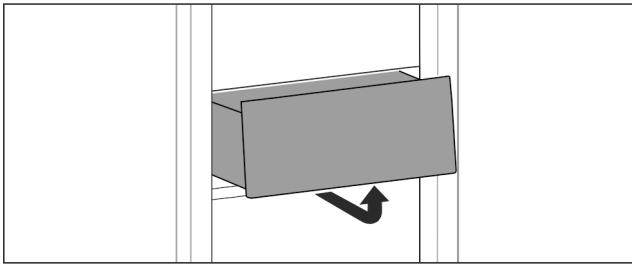

Fig. 21

- ▶ Remove drawer as shown in the illustration.

## Inserting drawer

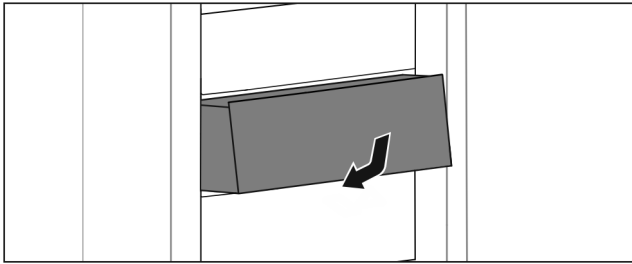

Fig. 22

- ▶ Insert drawer as shown in the illustration.

## 7.1.2 Drawer on telescopic rails\*

The drawer runs on extendible rails (telescopic rails). There are fully extendible telescopic rails and telescopic rails with partial pull-out. Drawers which are fully extendible can be pulled out fully from the appliance. Drawers with partial pull-out cannot be removed fully from the appliance. The system in your appliance depends on the type of appliance.

### Drawer on glass shelf

The drawer guided on a glass shelf is a partial pull-out.

## Removing drawer

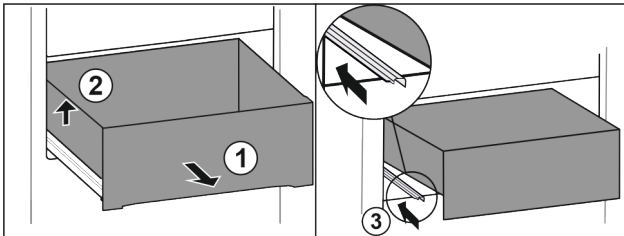

Fig. 23

- ▶ Pull out drawer as far as it will go. Fig. 23 (1)
- ▶ Lift drawer on the left. Fig. 23 (2)
- ▶ Insert left rail. Fig. 23 (3)

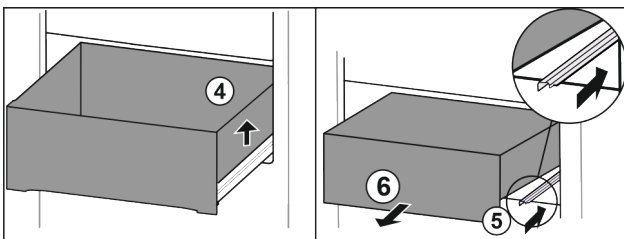

Fig. 24

- ▶ Lift drawer on the right. Fig. 24 (4)
- ▶ Insert right rail. Fig. 24 (5)
- ▶ Remove drawer to the front. Fig. 24 (6)

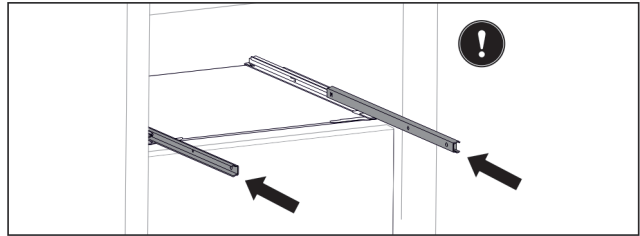

Fig. 25

If the rails are not yet fully inserted after removing the drawer:

- ▶ Push rails in completely.

## Inserting drawer

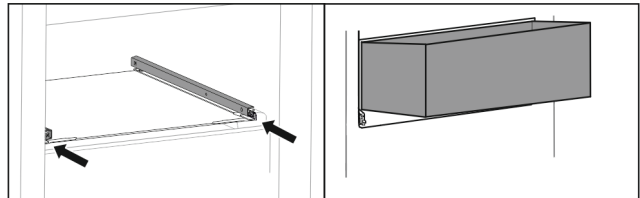

Fig. 26

- ▶ Slide rails in.
- ▶ Place drawer on rails at an angle.

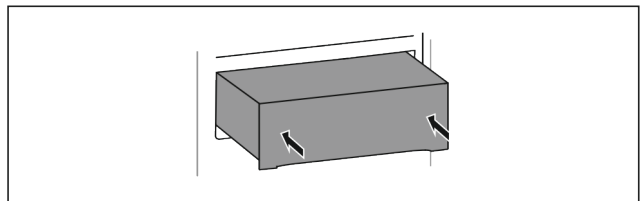

Fig. 27

- ▶ Lower drawer.
- ▶ Slide in drawer to the back.

## 7.1.3 Top tilting drawer\*

When you pull out the top drawer, it tilts forward. This gives you a better view into the drawer. The function depends on the height of the appliance.

When you remove the tilting drawers, you can use the glass shelf below them as a storage shelf.

## Removing drawer

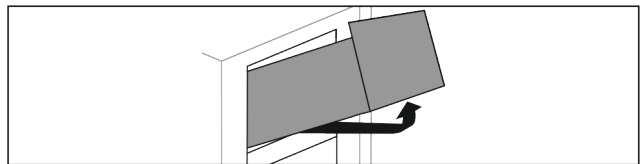

Fig. 28

- ▶ Pull out drawer as far as it will go.
- ▶ Lift drawer up at the front and at the same time push up at the back from below.
- ▶ Remove drawer to the front.

## Inserting drawer

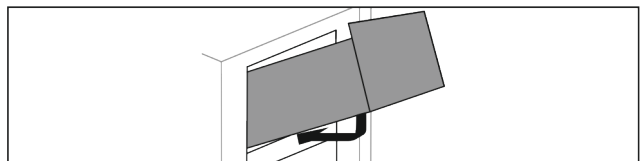

Fig. 29

- ▶ Position drawer as shown.
- ▶ The drawer rests on the glass panel.
- ▶ Lift drawer slightly from below at the back and slide over the lip.
- ▶ Slide in drawer to the back.



# Features

## 7.1.4 Drawer on moulded rib\*

The drawer runs directly on the moulded rib. There are no rails.

### Removing drawer

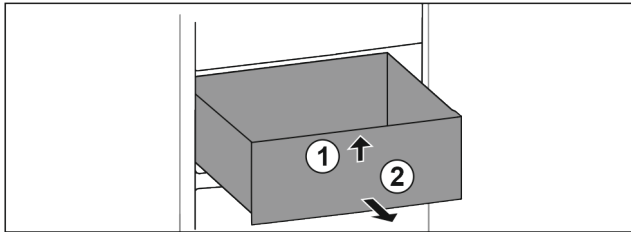

Fig. 30

- ▶ Pull out drawer as far as it will go.
- ▶ Lift up drawer at the front. Fig. 30 (1)
- ▶ Remove drawer to the front. Fig. 30 (2)

### Inserting drawer

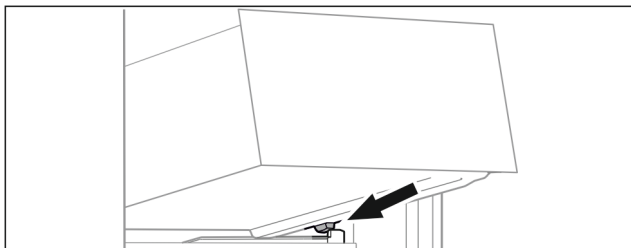

Fig. 31

- ▶ Place drawer at an angle behind the stoppers on the moulded rib. (see Fig. 287)
- ▶ Lower drawer.
- ▶ Slide in drawer to the back.

## 7.2 Pull-out board with IceTower\*

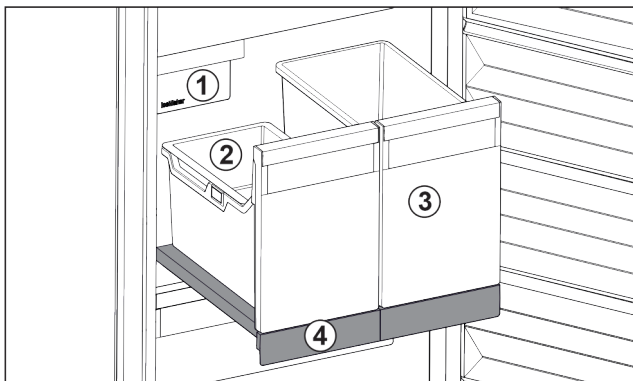

Fig. 32 Pull-out board with IceTower

- |                                |   |
|--------------------------------|---|
| (1) IceMaker                   | (3) Container for pizza or alcoholic beverages, for example |
| (2) Hang-on tray for ice cubes | (4) Pull-out board  |

There are two high (IceTower) containers on the pull-out board. Ice cubes from the IceMaker are collected and stored in the Fig. 32 (2) container. The container Fig. 32 (3) is suitable for storing tall foodstuffs or beverages such as pizzas or alcoholic drinks.

The pull-out board with IceTower is mounted on a glass shelf with pull-out rails. You can dismantle the pull-out board for cleaning.

## 7.2.1 Dismantling the pull-out board with IceTower

### Removing the container

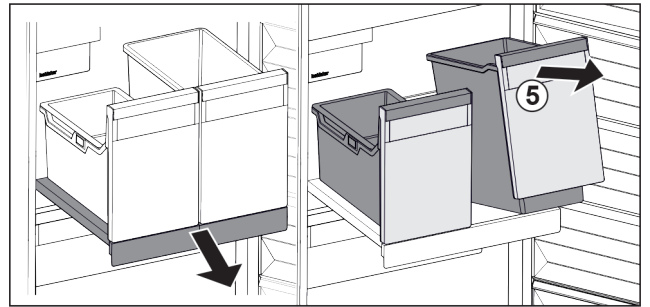

Fig. 33

- ▶ Pull out the pull-out board.
- ▶ Lift the container Fig. 33 (5) at the front.
- ▶ Remove the container.

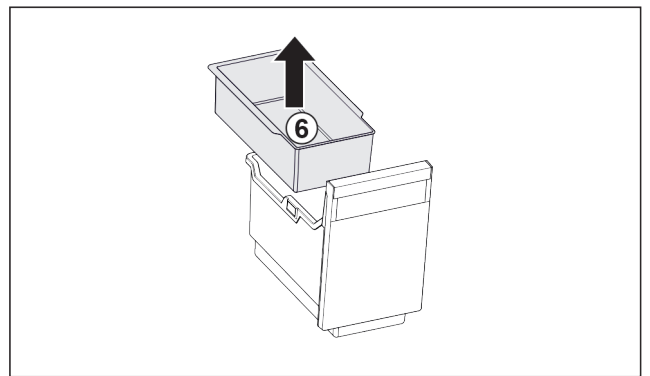

Fig. 34

- ▶ Remove the hang-on tray Fig. 34 (6).
- ▶ If there are ice cubes in the hang-on tray: Empty the hang-on tray.
- ▷ The container and hang-on tray have been removed and you can clean them. (see 8.3.3 Clean the components)

### Removing the pull-out board

Ensure that the following conditions are met:

- Containers have been removed. (see 7.2.1.1 Removing the container)

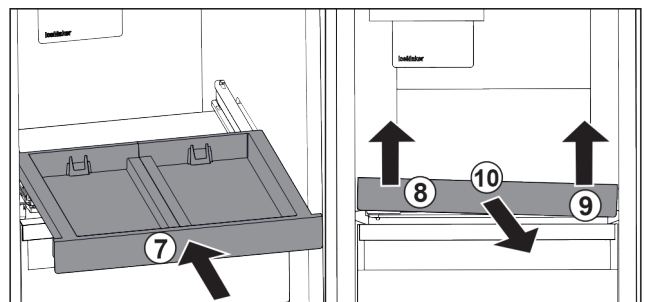

Fig. 35

- ▶ Slide in the pull-out board. Fig. 35 (7)
- ▶ Lift the pull-out board on the front left. Fig. 35 (8)
- ▶ Lift the pull-out board on the front right. Fig. 35 (9)
- ▷ Pull-out board is detached from the attachment at the front.
- ▶ Take out the pull-out board to the front. Fig. 35 (10)
- ▷ The pull-out board has been removed and you can clean it. (see 8.3.3 Clean the components)

### Removing the glass shelf from under the pull-out board

(see 7.3 Glass shelves\*)

## 7.2.2 Inserting the pull-out board with IceTower

### Inserting the glass shelf from under the pull-out board

(see 7.3 Glass shelves\*)

#### Inserting the pull-out board

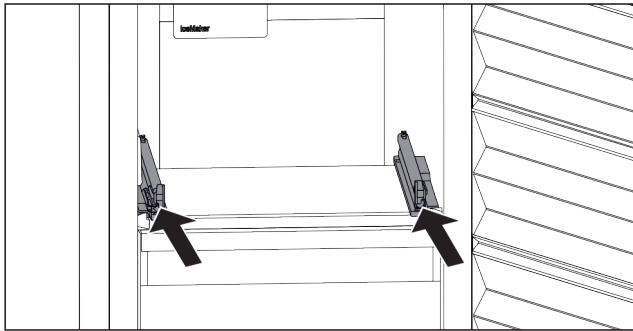

Fig. 36

- ▶ Slide the rails in.

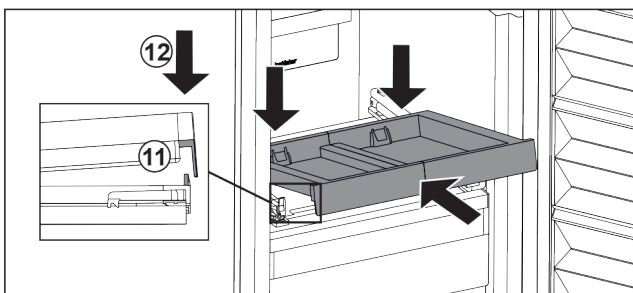

Fig. 37

- ▶ Place the pull-out board in at an angle behind the front lug.
- ▶ Slide in at an angle. Make sure that the stop is behind the lug on both sides. Fig. 37 (11)
- ▶ Lower the pull-out board at the front. Fig. 37 (12)

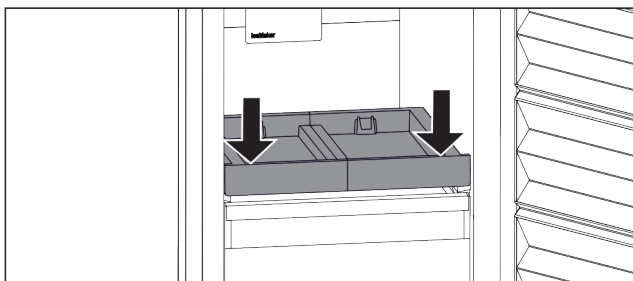

Fig. 38

- ▶ Push the pull-out board down at the front.
- ▷ Pull-out board clicks into place.

#### Inserting the container

Ensure that the following conditions are met:

- The pull-out board is inserted. (see 7.2.2.2 Inserting the pull-out board)

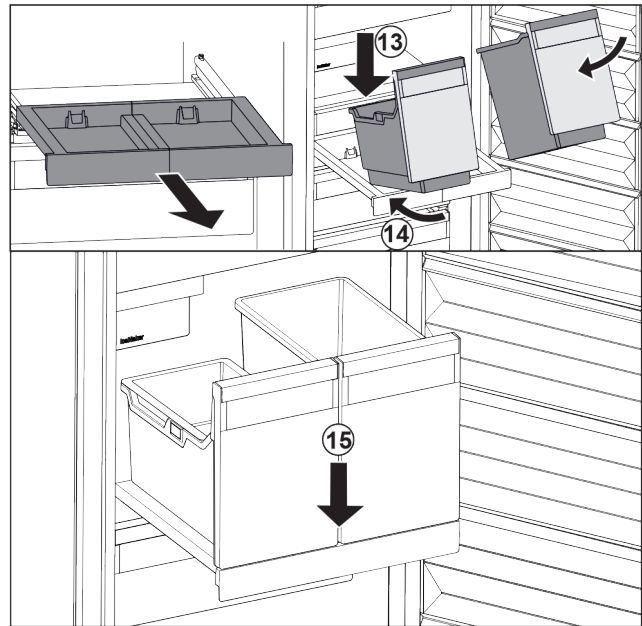

Fig. 39

- ▶ Pull out the pull-out board.
- ▶ Hold the pull-out board with one hand.

#### Note

The containers are shaped in a way that they cannot be interchanged.

- ▶ Place the container at an angle on the pull-out board. Fig. 39 (13)
- ▶ Slide the container to the back at an angle. Fig. 39 (14)
- ▶ Place container in the front. Fig. 39 (15)

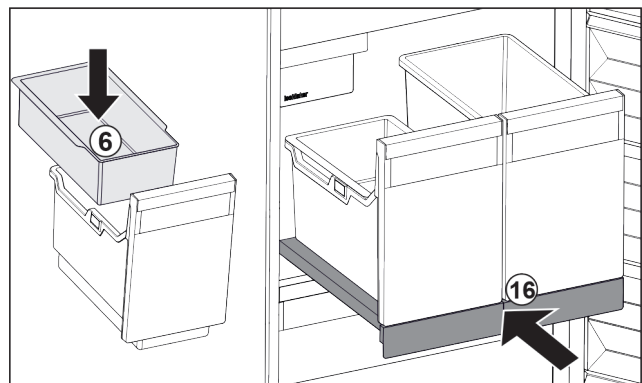

Fig. 40

- ▶ Insert hang-on tray Fig. 40 (6) for ice cubes.
- ▶ Slide in the pull-out board with (IceTower) container. Fig. 40 (16)
- ▷ Pull-out shelf with IceTower is fully inserted.

## 7.3 Glass shelves\*

### NOTICE

Impermissible removal of the glass panel above the IceTower!\*

Damage to the IceMaker. The IceMaker is attached to the glass panel above the IceTower.

- ▶ Do not remove the glass panel above the IceTower.

You can remove the glass shelves under the drawers for cleaning.

You can remove the glass shelves under the drawers to use VarioSpace.

# Features

## 7.3.1 Removing / inserting the glass shelf under the tilting drawer\*

The glass shelf is located under the top tilting drawer.

Make sure that the following requirements are fulfilled:

- ❑ Drawer has been removed. (see 7.1.3 Top tilting drawer\*)

### Removing glass shelf

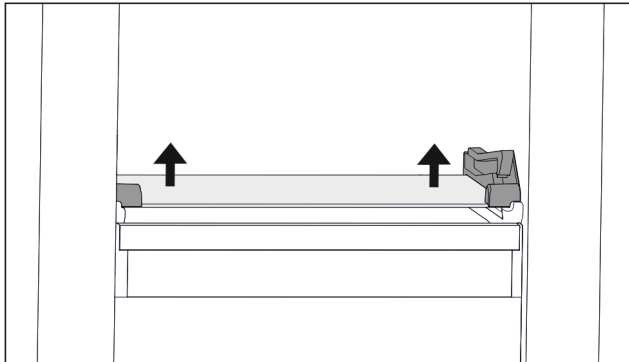

Fig. 41 Tilting drawer glass shelf

- ▶ Push glass shelf upwards from below on both sides. (see Fig. 297)
- ▶ Take out the glass shelf to the front.

### Inserting glass shelf

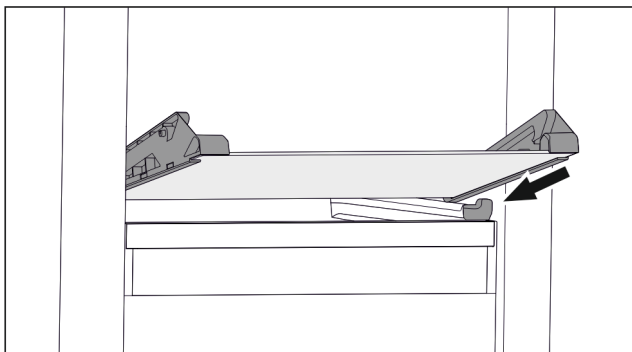

Fig. 42 Tilting drawer glass shelf

- ▶ Position glass shelf at an angle behind the stoppers. (see Fig. 298)
- ▶ Lower glass shelf.
- ▶ Slide in glass shelf to the back.
- ▷ Glass shelf clicks into place.

## 7.3.2 Removing / inserting the glass shelf

Depending on the equipment, the glass shelf may be located under the drawer.

Depending on the equipment, the glass shelf may be located under the IceTower.\*

\*

Make sure that the following requirements are fulfilled:

- ❑ Glass shelf under the drawer: The drawer has been removed. (see 7.1 Drawers)
- ❑ Pull-out board under IceTower: IceTower has been removed. (see 7.2 Pull-out board with IceTower\*) \*

## Removing glass shelf

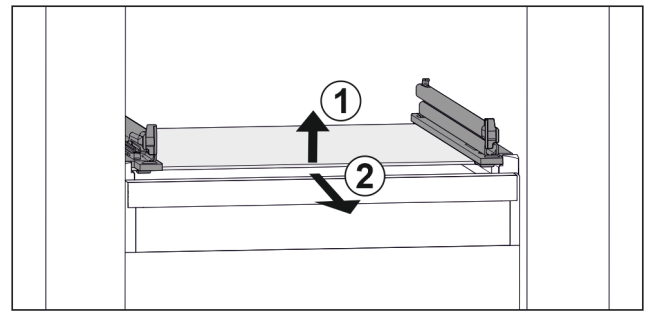

Fig. 43 Example illustration of glass shelf

- ▶ Lift glass shelf at the front. Fig. 43 (1)
- ▶ Take out glass shelf to the front. Fig. 43 (2)

## Inserting glass shelf

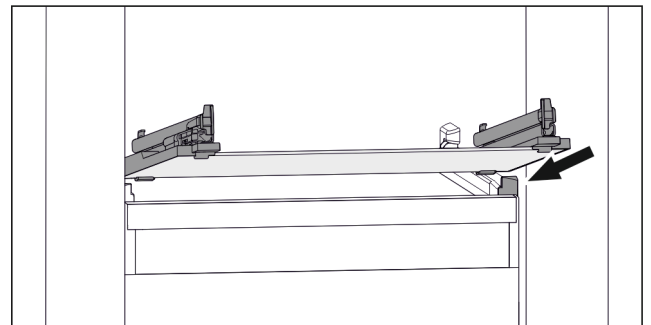

Fig. 44 Example illustration of glass shelf

- ▶ Position glass shelf at an angle behind the stoppers. (see Fig. 300)
- ▶ Lower glass shelf.
- ▶ Slide in glass shelf to the back.

## 7.4 IceMaker\*

The IceMaker will produce ice cubes for household use only.

Ensure that the following conditions are met:

- IceMaker is cleaned (see 8 Maintenance) .
- IceMaker drawer is cleaned.
- IceMaker drawer is fully inserted.

### 7.4.1 Producing ice cubes

The volume depends on the freezing temperature. The colder the temperature, the more ice cubes the system can produce in a certain time period.

After the IceMaker is turned on for the first time, it can take up to 24 hours for the first ice cubes to be made.

- ▶ Activate the IceMaker function (see 6.2 Control concept) .
- ▶ To make a high number of ice cubes: Activate the MaxIce function (see 6.2 Control concept) .
- ▶ Distribute the ice cubes evenly in the drawer to increase the capacity.
- ▶ Closing the drawer: IceMaker starts making ice cubes again automatically.

### Note

When a certain level is reached in the IceMaker drawer, it stops producing ice cubes. The IceMaker does not fill the drawer all the way to the top.

## 7.5 VarioSpace

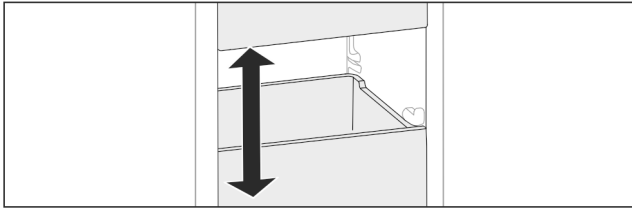

Fig. 45

You can remove drawers and glass panels from your appliance. This provides more room for large food items such as poultry, joints of meat, large game, and tall baked products. You can then freeze these items whole for later preparation.

- ▶ Note the weight limits on the drawers and glass panels (see 9.1 Technical specifications).

## 7.6 Accessories

### 7.6.1 Freezer pack

Freezer packs prevent the temperature rising too quickly should there be a power cut.

The freezer packs are in the drawer.

You can store the freezer packs in the freezer tray.

#### Using the freezer pack

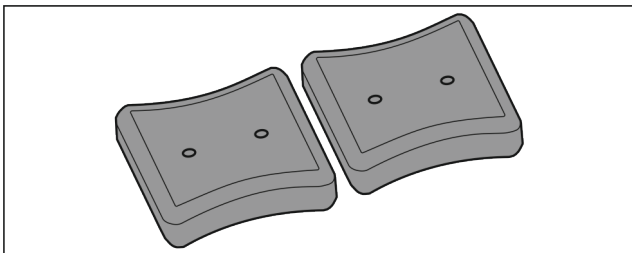

Fig. 46

When the freezer packs are fully frozen:

- ▶ Place on the frozen goods in the top, front part of the freezer.

### 7.6.2 Ice cube tray with cover\*

#### Using the ice cube tray

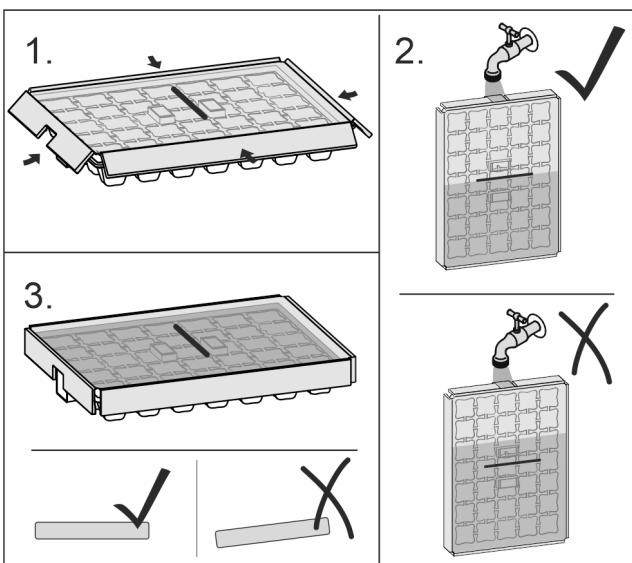

Fig. 47

When the water is frozen:

- ▶ Hold ice cube tray under hot water for a short time.
- ▶ Remove the lid.

- ▶ Gently turn the ends of the ice cube tray in opposite directions.
- ▶ Release the ice cubes.

#### Dismantling the ice cube tray

You can take the ice cube tray apart for cleaning.

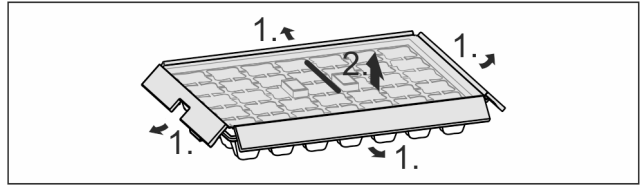

Fig. 48

- ▶ Disassembling the ice cube tray.

## 8 Maintenance

### 8.1 Disassembling / assembling pull-out systems

#### 8.1.1 Notes on disassembly

You can disassemble some of the pull-out systems for cleaning. Your appliance can contain a variety of pull-out systems.

The following pull-out systems can be disassembled or cannot be disassembled:

Pull-out system	can be disassembled / cannot be disassembled
Drawer on appliance base or glass shelf	cannot be disassembled
Drawer on glass shelf	can be disassembled (see 8.1.2.1 Drawer on glass shelf)
Top tilting drawer*	can be disassembled (see 8.1.3 Top tilting drawer*) *
Drawer on moulded rib*	can be disassembled (see 8.1.4 Drawer on moulded rib*) *
IceTower*	can be disassembled (see 8.1.5 IceTower*) *

#### 8.1.2 Drawer on telescopic rails\*

##### Drawer on glass shelf

##### Disassembling pull-out system

Make sure the following prerequisites are met:

- Drawer has been removed.
- Glass shelf has been removed. (see 7.3 Glass shelves\*)

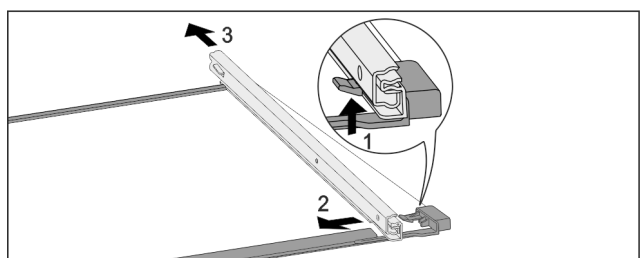

Fig. 49 Glass shelf with rails

- ▶ Push up front click-in hooks. (1)
- ▶ Move pull-out rails to the side (2) and to the rear (3).

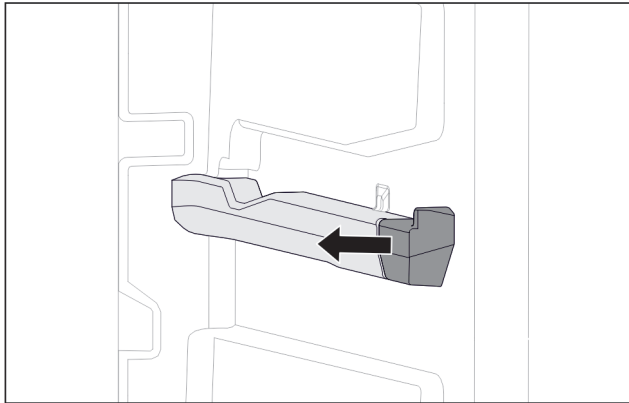

Fig. 50 Attachment on the right moulded rib

- ▶ Remove moulded rib attachment sideways.

### Installing pull-out system

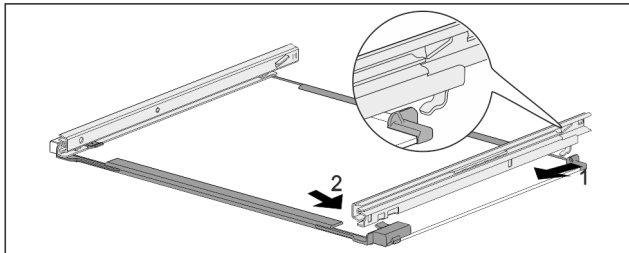

Fig. 51 Glass shelf with rails

- ▶ Hook in rail at the back. (1)
- ▶ Hook in rail at the front. (2)

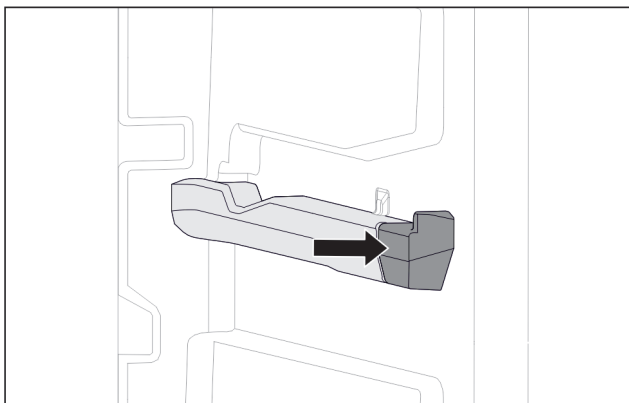

Fig. 52 Attachment on the right moulded rib

- ▶ Press attachment onto moulded rib.

### 8.1.3 Top tilting drawer\*

#### Disassembling pull-out system

Make sure the following prerequisites are met:

- Drawer has been removed. (see 7.1.3 Top tilting drawer\*)
- Glass shelf has been removed. (see 7.3 Glass shelves\*)

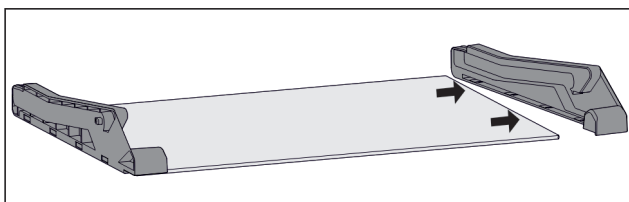

Fig. 53 Glass shelf with side parts

- ▶ Pull off side part from glass shelf sideways.

### Installing pull-out system

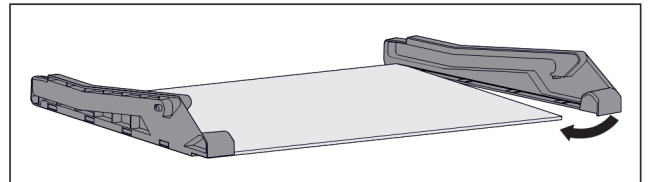

Fig. 54 Glass shelf with side parts

- ▶ Place on side part at the back.
- ▶ Press side part onto glass shelf at the front.

### 8.1.4 Drawer on moulded rib\*

#### Disassembling pull-out system

Make sure the following prerequisites are met:

- Drawer has been removed. (see 7.1.4 Drawer on moulded rib\*)

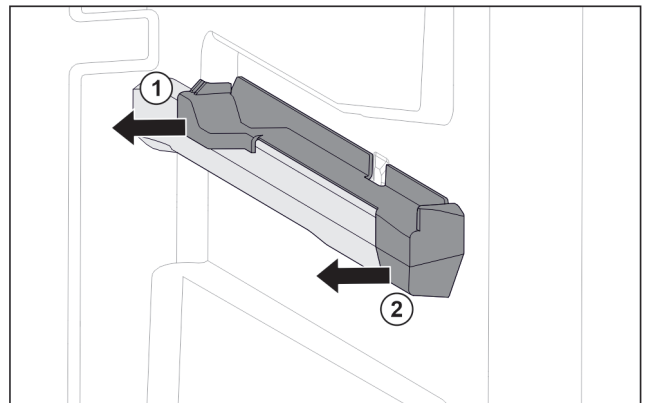

Fig. 55 Attachment on the right moulded rib

- ▶ Grab attachment at the back from below.
- ▶ Pull off attachment at the back sideways. Fig. 55 (1)
- ▶ Pull off attachment at the front sideways. Fig. 55 (2)

### Installing pull-out system

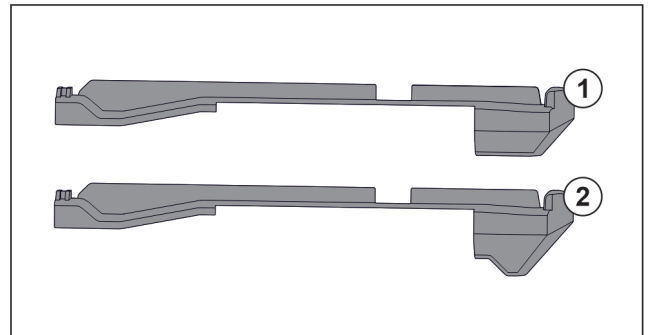

Fig. 56 Comparing attachments

There are two different attachments in the appliance. The attachment above the lowest drawer Fig. 56 (2) has a three-cornered edge. All other attachments Fig. 56 (1) have a straight edge.

- ▶ Fit attachment Fig. 56 (2) with the three-cornered edge above the lowest drawer.
- ▶ Fit attachment Fig. 56 (1) with straight edge in all other positions.



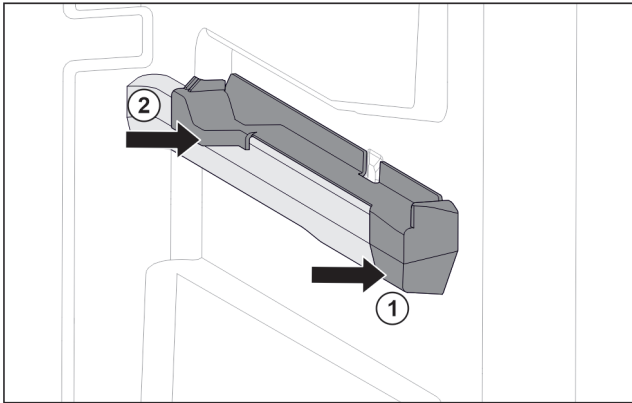

Fig. 57 Attachment on the right moulded rib

- ▶ Position attachment on moulded rib at the front. Fig. 57 (1)
- ▶ Press on attachment at the back. Fig. 57 (2)

## 8.1.5 IceTower\*

### Disassembling pull-out system

Make sure the following prerequisites are met:

- IceTower has been removed. (see 7.2 Pull-out board with IceTower\*)
- Glass shelf has been removed. (see 7.3 Glass shelves\*)
- ▶ Place pull-out board on a table.
- ▷ You are able to remove the rails more easily from the glass shelf.

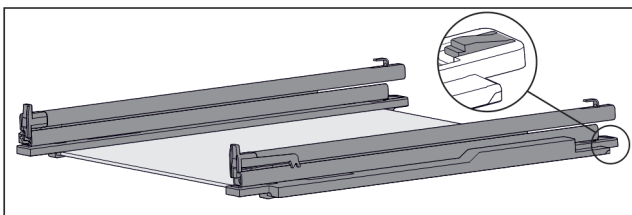

Fig. 58 Glass shelf with rails and retaining parts

- ▶ Press down retaining part at the rear (see Fig. 314) and at the same time push the rail back.

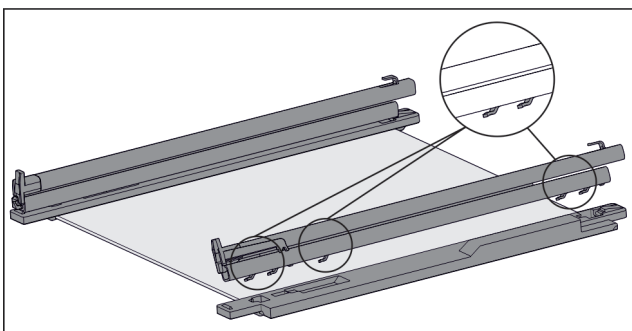

Fig. 59 Glass shelf with rails and retaining parts

- ▷ The rail hooks are released from the retaining part.
- ▶ Remove rail from retaining part.

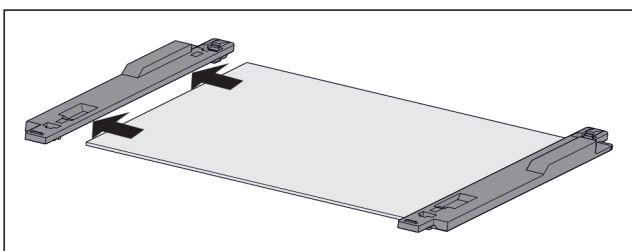

Fig. 60 Glass shelf with retaining part

- ▶ Remove retaining part from glass shelf sideways.

### Installing pull-out system

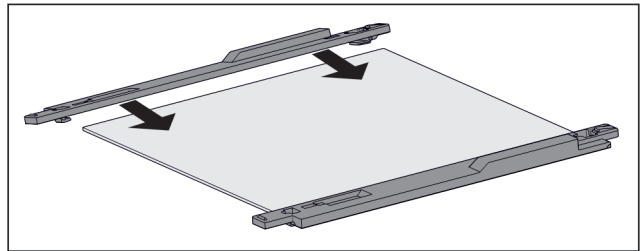

Fig. 61 Glass shelf with retaining part

- ▶ Fit retaining part on glass shelf.
- ▶ Push retaining part onto glass shelf as far as it will go.

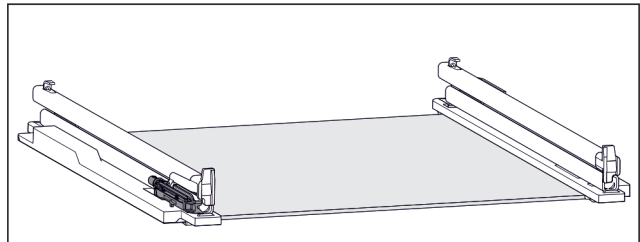

Fig. 62 Damping mechanism

The damping mechanism is attached to the left rail. (see Fig. 318) There is no damping mechanism attached to the right rail.

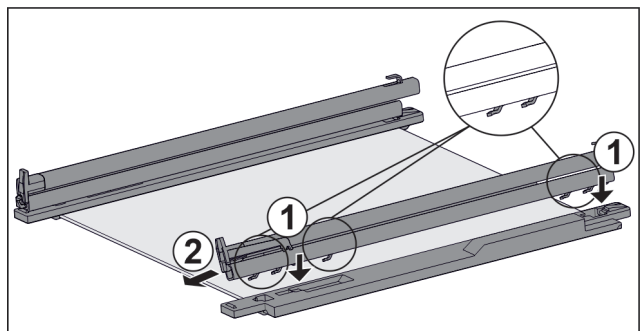

Fig. 63 Glass shelf with rails and retaining parts

Install rail **with** damping mechanism:

- ▶ Place rail hooks onto the openings of the **left** retaining part. Fig. 63 (1)
- ▶ Push rail forwards. Fig. 63 (2)
- ▷ Rail latches in audibly.

Install rail **without** damping mechanism:

- ▶ Place rail hooks onto the openings of the **right** retaining part. Fig. 63 (1)
- ▶ Push rail forwards. Fig. 63 (2)
- ▷ Rail latches in audibly.

## 8.2 Defrosting the appliance

### 8.2.1 Defrosting with NoFrost

Defrosting is performed automatically with the NoFrost system. The moisture is deposited on the evaporator, is periodically defrosted and evaporates.

The appliance does not need to be defrosted.

## 8.3 Cleaning the appliance

### 8.3.1 Ready



#### WARNING

Danger of electric shock!

- ▶ Remove the refrigerator connector or interrupt the power supply.



#### WARNING

Risk of fire

- ▶ Do not damage the refrigeration circuit.

- ▶ Empty the appliance.
- ▶ Remove mains connector.

### 8.3.2 Cleaning the interior

#### NOTICE

Improper cleaning!  
Damage to the appliance.

- ▶ Only use soft cleaning cloths and ph-neutral all-purpose cleaners.
  - ▶ Do not use abrasive sponges or steel wool which may cause scratches.
  - ▶ Do not use any sharp or abrasive cleaning agents, nor any that contain sand, chloride or acid.
- 
- ▶ Plastic surfaces: clean by hand with a soft clean cloth, lukewarm water and a little detergent.
  - ▶ Metal surfaces: clean by hand with a soft clean cloth, lukewarm water and a little detergent.

### 8.3.3 Clean the components

#### NOTICE

Improper cleaning!  
Damage to the appliance.

- ▶ Only use soft cleaning cloths and ph-neutral all-purpose cleaners.
- ▶ Do not use abrasive sponges or steel wool which may cause scratches.
- ▶ Do not use any sharp or abrasive cleaning agents, nor any that contain sand, chloride or acid.

**Clean with a soft, clean cloth, lukewarm water and some detergent:**

- IceTower pull-out board\*
- Drawer  
Please note: Do not remove the magnet on the drawer. The magnet ensures the functionality of the IceMaker.\*
- Freezer tray

**Clean with a damp cloth:\***

- Retractable rails  
Please note: The grease in the tracks is used for lubrication and must not be removed!

**Wash in the dishwasher up to 60 °C:**

- Ice cube tray\*
- Ice cube scoop\*
- ▶ To disassemble components: see the relevant section.
- ▶ Clean the components.

### 8.3.4 Cleaning the IceMaker\*

There are various options for cleaning the IceMaker.

Cleaning is required in the following cases:

- Initial operation
- If out of use for more than 5 days.\*

Ensure that the following conditions are met:

- IceMaker drawer is emptied.
- IceMaker drawer is in place.
- The IceMaker is activated. (see 6.2 Control concept)

#### First use or after a long period of non-use

Clean the IceMaker with the TubeClean function.

- ▶ Place a 1.5 l empty container (max. height 10 cm) into the drawer under the IceMaker.
- ▶ Activate the TubeClean function. (see 6.2 Control concept)
- ▷ The rinse process is prepared (max. 60 min.): Symbol flashes.
- ▷ Water pipes are rinsed: Symbol flashes.
- ▷ Rinsing process is complete: Function turns off automatically.
- ▶ Remove the IceMaker drawer and remove the container.
- ▶ Clean the IceMaker drawer with warm water and a little detergent.
- ▶ Push the IceMaker drawer in.
- ▷ The system starts making ice cubes automatically.
- ▶ Dispose of any ice cubes that were made 24 hours after the first ice cubes.

#### If cleaning is required

Clean the IceMaker by hand.

- ▶ Remove the IceMaker drawer and clean with warm water and a little detergent.
- ▶ Push the IceMaker drawer in.
- ▷ The system starts making ice cubes automatically.

### 8.3.5 After cleaning

- ▶ Wipe the appliance and the components dry.
- ▶ Connect and switch on the appliance.
- ▶ Activate SuperFrost (see 6.3 Functions) .  
The temperature is cold enough:
- ▶ Place the food inside.
- ▶ Repeat cleaning regularly.

## 9 Customer help

### 9.1 Technical specifications

Temperature range		
Freeze		-28 °C to -15 °C
Maximum freezing quantity / 24 h		
Freezer compartment		See "Freezing capacity ... /24 h" on the serial tag



Maximum component capacity			
Features	Appliance width 550 mm (see installation instructions, appliance dimensions)	Appliance width 600 mm (see installation instructions, appliance dimensions)	Appliance width 700 mm (see installation instructions, appliance dimensions)
Drawer on glass shelf* (see 7.1.1 Drawer on appliance base or glass shelf) *	12 kg*	15 kg*	--*
Drawer on moulded rib* (see 7.1.4 Drawer on moulded rib*) *	14 kg*	19 kg*	19 kg*
Drawer on glass shelf (see 7.1.2 Drawer on telescopic rails*)	12 kg	15 kg	22 kg

Ice cube production with IceMaker*	
Ice cube production / 24 h	At a temperature of -18 °C: 0.8 kg of ice cubes
Maximum ice cube production / 24 hours	With the MaxIce function on: 1.2 kg of ice cubes

Lighting	
Class <sup>1</sup>	Light source
This product contains one or more energy efficiency class G light sources.	LED

*1 The appliance may contain light sources with different energy efficiency classes. The lowest energy efficiency class is indicated.*

For appliances with a WiFi connection:\*

Frequency specification*	
Frequency band	2.4 GHz
Maximum radiated power	< 100 mW
Purpose of the wireless equipment	Integration in the local WiFi network for data communication

## 9.2 Operating noises

The appliance makes different noises when it is on.

- At **higher temperatures** the appliance uses less energy but works for longer. It is **quieter**.
- At **lower temperatures** the food is cooled faster. It is **louder**.

Examples:

- Functions on (see 6.3 Functions)
- Fan running
- Food recently added
- High ambient temperature
- Door open for a while

Noise	Possible cause	Type of noise
Bubbling and splashing	Coolant flowing into the cooling circuit.	Normal operating noise
Hissing	Coolant sprays into the cooling circuit.	Normal operating noise
Humming	The appliance is cooling. The volume depends on the cooling output.	Normal operating noise
Suction noises	Soft-closing door is being opened and closed.	Normal operating noise
Humming and rustling	The fan is running.	Normal operating noise
Clicking	Components are switched on and off.	Normal switching noise
Rattling humming or	Valves or flaps are working.	Normal switching noise

Noise	Possible cause	Type of noise	Lifting
Vibration	Improper installation	Defective noise	Check the installation. Level the appliance.
Rattling	Components, items inside the appliance	Defective noise	Secure components. Leave enough space between the items.

## 9.3 Technical fault

Your appliance is designed and built to ensure it works reliably and has a long service life. In the unlikely event that a fault occurs during operation, please check whether it is due to an operating error. If so, you will be charged for the

# Customer help

callout and repair costs even if it falls within the warranty period.

You can fix the following faults yourself.

## 9.3.1 Appliance function

Defect	Cause	Remedy
<b>The appliance is not working.</b>	→ The appliance is not switched on.	▶ Switch the appliance on.
	→ The power plug is not properly plugged into the socket.	▶ Check the power plug.
	→ There is something wrong with the power outlet fuse.	▶ Check the fuse.
	→ Power cut	▶ Keep the appliance closed. ▶ Protecting food: Lay freezer packs on top of the food or use another freezer if the power is off for a prolonged period. ▶ Do not re-freeze defrosted food,
	→ The appliance plug does not fit the appliance properly.	▶ Check the appliance plug.
<b>Temperature is not cold enough.</b>	→ The appliance door is not closed properly.	▶ Close the appliance door.
	→ Not enough ventilation.	▶ Keep ventilation grille clear, and clean it.
	→ The ambient temperature is too high.	▶ Solution: (see 1.4 Appliance range of use) .
	→ The appliance was opened too many times or for too long.	▶ Wait to see if the required temperature corrects itself. If not, contact Customer Service (see 9.4 Customer Services) .
	→ Too much fresh food was placed inside without SuperFrost.	▶ Solution: (see SuperFrost)
	→ The temperature is set incorrectly.	▶ Turn down the temperature and check after 24 hours.
	→ The appliance is too close to a heat source (oven, radiator, etc).	▶ Move the appliance or the heat source.
	→ The appliance was not correctly installed in the recess.	▶ Check if the appliance was installed correctly and that the door closes properly.
<b>The door seal is defective or needs to be replaced for another reason.</b>	→ The door seal can be replaced. It can be replaced without the need for special tools.	▶ Contact Customer Services (see 9.4 Customer Services) .
<b>The appliance builds up too much ice or condensation.</b>	→ The door seal may have slipped out of its groove.	▶ Check that the door seal is well fitted in the groove.

## 9.3.2 Features

Defect	Cause	Remedy
<b>You cannot activate the IceMaker.*</b>	→ The appliance and therefore the IceMaker are not connected.	▶ Connect the appliance (see the Installation Guide).
<b>The IceMaker is not producing ice cubes.*</b>	→ The IceMaker is not on.	▶ Activate the IceMaker.
	→ The drawer of the IceMakers is not connected properly.	▶ Push the drawer in correctly.
	→ The water connection is not open.	▶ Open the water connection.*
<b>The internal light does not come on.</b>	→ The appliance is not switched on.	▶ Switch the appliance on.
	→ The door was open for longer than 15 minutes.	▶ Interior lighting turns off automatically after approx. 15 min. with the door open.

Defect	Cause	Remedy
	→ The LED interior light is faulty or the lid is damaged.	▶ Contact customer service (see 9.4 Customer Services) .

## 9.4 Customer Services

First check if you can fix the error yourself (see 9 Customer help) . If you can't, contact Customer Services.

Please refer to the enclosed "Liebherr-Service" brochure for the address.



### WARNING

Unprofessional repair!  
Injuries.

- ▶ Have any repairs and action - not expressly specified - on the appliance and mains cable carried out by service personnel only. (see 8 Maintenance)
- ▶ A damaged mains cable may only be replaced by the manufacturer, the manufacturer's Customer Service or a similarly qualified person.
- ▶ In the case of appliances with an IEC connector, the change may be made by the customer.

### 9.4.1 Contact Customer Services

Make sure you have the following appliance data at the ready:

- Appliance name (model and index)
- Service no. (Service)
- Serial no. (S no.)

- ▶ Look up the appliance information on the display (see Info) .

-or-

- ▶ Referring to appliance info on the nameplate (see 9.5 Model plate) .
- ▶ Note down the appliance information.
- ▶ Notify Customer Services of the following: Give us the appliance data.
- ▶ This will help us to provide you with a faster, more accurate service.
- ▶ Follow any further instructions given by Customer Services.

## 9.5 Model plate

The model plate is behind the drawers on the inside of the appliance.

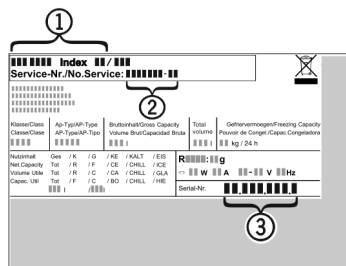

Fig. 64

- (1) Appliance description
- (2) Service no.
- (3) Serial no.

- ▶ Note the data on the model plate.

## 10 Shutting down

- ▶ Empty the appliance.
- ▶ Turn off the IceMaker.\*
- ▶ Turn off the appliance .
- ▶ Remove mains connector.
- ▶ Remove appliance connector if required: Remove and move from left to right at the same time.
- ▶ Clean the appliance (see 8.3 Cleaning the appliance) .
- ▶ Leave the door open to avoid bad smells building up.

## 11 Disposal

### 11.1 Preparing appliance for disposal



Liebherr uses batteries in some of its appliances. In the EU, for environmental reasons, legislation obliges the end user to remove these batteries before disposing of old appliances. If your appliance contains batteries, a corresponding notice is attached.

Lamps If you can remove the lamps yourself without destroying them, also remove these before disposal.

- ▶ Take the appliance out of operation.
- ▶ Appliances with batteries: remove the batteries. For description, see **Maintenance** chapter.
- ▶ If possible: remove lamps without destroying them.

### 11.2 Disposing of the appliance in an environmentally friendly manner



The appliance still contains valuable materials and must be disposed of separately from unsorted municipal waste.



Dispose of batteries separately from the old appliance. To do this, you can return the batteries free of charge to retailers as well as recycling centres and collection centres for recyclable materials.

Lamps

Dispose of removed lamps via the respective collection systems.

For Germany:

You can dispose of the appliance free of charge via the class 1 collection containers at the local recycling and recyclable material collection centres. When purchasing a new fridge/freezer, if the sales area > 400 m<sup>2</sup>, retailers will also take back the old appliance free of charge.

# Disposal

---



## **WARNING**

Leaking coolant and oil!

Fire. The coolant contained in the appliance is eco-friendly, but also flammable. The oil contained in the appliance is flammable. Escaping coolant and oil can ignite if the concentration is high enough and in contact with an external heat source.

- ▶ Do not damage the pipelines of the coolant circuit and the compressor.
- 
- ▶ Transport the appliance without damaging it.
  - ▶ Dispose of batteries, lamps and the appliance according to the above specifications.





[home.liebherr.com/fridge-manuals](https://home.liebherr.com/fridge-manuals)

**EN** built-in fridges and freezers

Issue date: 20230411

**Part number index: 7088270-00**

Liebherr-Hausgeräte GmbH  
Memminger Straße 77-79  
88416 Ochsenhausen  
Deutschland