

Operating instructions

Cigar storage unit

Page 18



Many thanks for your trust.

Congratulations on your purchase of this cigar storage unit. In buying this product, which is distinguished by its perfect user-friendliness, impeccable reliability and high quality, you have chosen a top class appliance.

Optimum humidity and temperature are key.

The very best humidors keep cigars at an even and constant relative humidity. Experts put the ideal level at 68-75% at an interior temperature of between 16 and 20°C. These climatic conditions allow the characteristic flavours of the cigar to unfold, the cigar will burn evenly and your enjoyment of the cigar and its taste will be enhanced. With the Liebherr cigar storage unit you can ensure constant humidity and a constant temperature - and control each one individually.

Naturally Spanish cedarwood.

The interior fittings of the Liebherr cigar storage unit are made of Spanish cedarwood. This top quality wood is used for the shelves and presentation boxes. Spanish cedarwood is used because it ensures an even climate inside the appliance, it helps the cigars to mature and its aroma enhances the unique flavour of exclusive cigars.

EPREL database

As from 1 March 2021, information about energy labelling and ecodesign requirements will be available in the European product database (EPREL). You can access the product database using the following link: <https://eprel.ec.europa.eu/>. You will be asked to enter the model identifier. You will find the model identifier on the type plate.

Content

	page
Setting up	20
Range of appliance use	20
Dimensions.....	20
Electrical requirement.....	21
Operating and control elements	21
Switching on for the first time.....	22
Setting the temperature	22
Adjusting the humidity	23
Lighting.....	23
Audible warning signal	24
Control elements.....	24
Setup mode	25
Equipment.....	27
Alternative interior layouts.....	28
Cleaning	30
Malfunctions	31
Safety instructions and warnings.....	32
Disposal notes.....	33
Wall mounting.....	33
Shutting your appliance down	33

Description of appliance and equipment

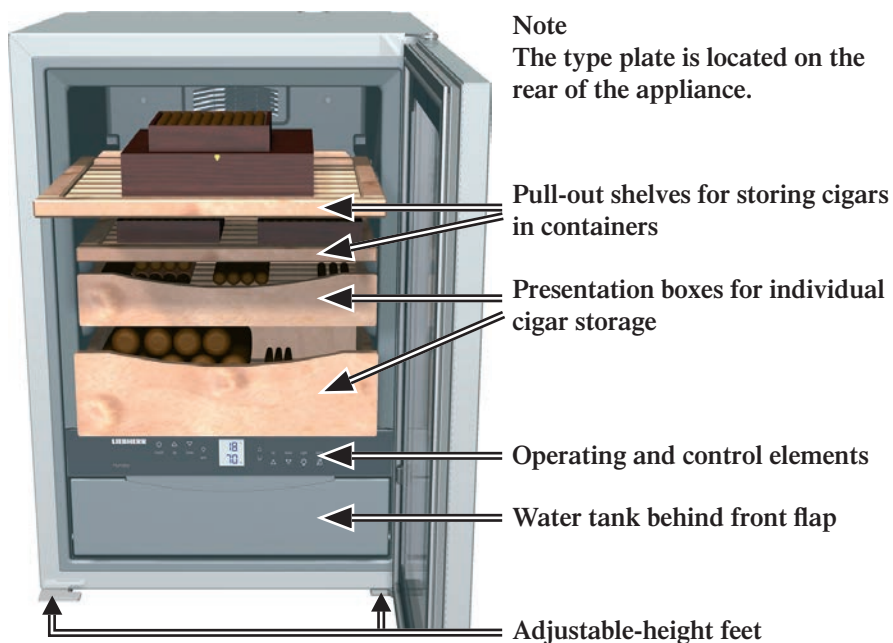

Setting up

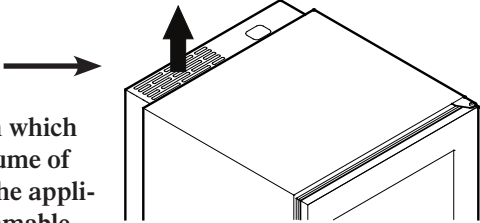
- Avoid positioning the appliance in direct sunlight or near cookers, radiators and similar sources of heat.
- The floor on which the appliance stands should be horizontal and level. Compensate for uneven floors with the adjustable feet.
- Do not cover ventilation openings or grille. 
- Standard EN 378 specifies that the room in which you install your appliance must have a volume of 1 m³ per 8 g of R 600a refrigerant used in the appliance, so as to avoid the formation of inflammable gas/air mixtures in the room where the appliance is located in the event of a leak in the refrigerant circuit. The quantity of refrigerant used in your appliance is indicated on the type plate of the appliance.
- The appliance is set to operate within specific ambient temperature limits according to its climate rating. These temperature limits should not be exceeded. The appliance has the following climate rating: N = +16°C to +32°C.
- When installing two appliances next to each other, always leave a gap of 50 mm to prevent condensation forming in the gap.

Humidity at the place of installation

To ensure fault-free operation of the appliance, 80% humidity at the place of installation must not be exceeded. Higher levels of humidity will cause error messages from the electronic control system.

Range of appliance use

This appliance is designed for storing cigars only.

The appliance is not suited for storing and cooling pharmaceuticals, blood plasma, laboratory preparations or similar substances and products subject to the Medical Devices Directive 2007/47/EC.

Any misuse of the appliance may result in damage to or spoilage of the stored goods.

Furthermore, the appliance is unsuited for use in areas exposed to an explosion hazard.

Dimensions

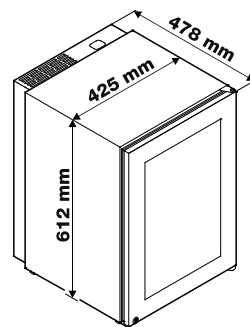

Electrical connection

Only operate the appliance with alternating current (AC). The permissible voltage and frequency are indicated on the type plate.

The socket must be properly earthed and protected by a fuse. The tripping current of the fuse must be between 10 A and 16 A.

The socket must not be situated behind the appliance and must be easily accessible.

Do not connect the appliance using an extension cable or extension socket.

Do not use stand-alone inverters (conversion of direct current to alternating/three-phase current) or energy-saving plugs. Risk of damage to the electronic control system!

Operating and control elements

The electronic control panel has the new "touch capacitance technology". Any function can be activated by touching the corresponding icon.

The exact contact point is between the symbol and its label. 

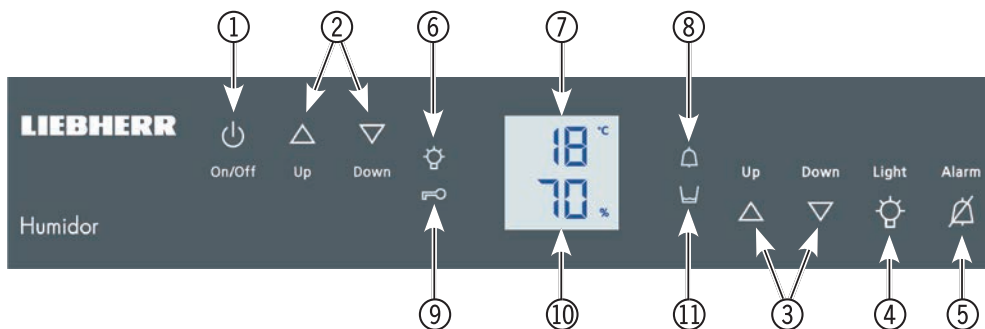

- ① Appliance ON/OFF
- ② Temperature setting buttons (for setting the interior temperature)
- ③ Humidity setting buttons (for setting the interior humidity)
- ④ Interior light ON/OFF
- ⑤ Mute alarm
- ⑥ Interior light On LED
- ⑦ Temperature display
- ⑧ Alarm LED (flashes to indicate a malfunction)
- ⑨ Child lock LED
- ⑩ Humidity display
- ⑪ Top up water tank

Switching on for the first time

Before switching on the appliance, fill the water tank with 1 litre of distilled water.

Use distilled water only!

Fold down the front flap completely and if necessary slide it into the appliance as far as it will go. Lift the water tank slightly, remove and fill with water.

Replace the water tank, sliding it in as far as it will go. Pull out the front flap completely and fold upwards at a 90° angle.

To switch on

Press the **On/Off** button. The display will flash.

The appliance will take 24 hours to reach the correct level for storing cigars (temperature, humidity).

The factory setting is +18°C and 70% humidity.

To switch off

Press the **On/Off** button for 3 seconds until the display goes dark.



Setting the temperature

To reduce the temperature

Press the **Down** button.

To increase the temperature

Press the **Up** button.

- While you are entering the temperature, the set temperature will flash on the display.

- The electronic controls will switch over automatically about 5 seconds after the last time you pressed the button, and the interior temperature will be displayed. The temperature can be set between +16°C and +20°C.



Adjusting the humidity

To reduce the humidity

Press the Down button.

To increase the humidity

Press the Up button.

- While you are setting the humidity, the display will flash.

- About 5 seconds after the button was last pressed, the actual interior humidity will be displayed.

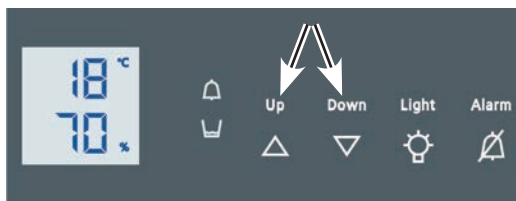

The humidity can be adjusted between 68% and 75%.

Extremely accurate measurement of humidity requires a complex sensor system such as the one integrated in your appliance. Separate measurements with hygrometers can produce humidity values that deviate from those on the humidor display. This can be the result of inaccurate measurement technology or the positioning of the sensor in the appliance.

Opening the door or placing fresh cigars in the appliance can affect the humidity level inside. This can also lead to deviations of the humidity displayed from the reference setting, without the appliance being defective.

Lighting

The light is integrated into the door frame and can be switched on and off by pressing the **Light** button.

The  LED lights up when the light is operational.

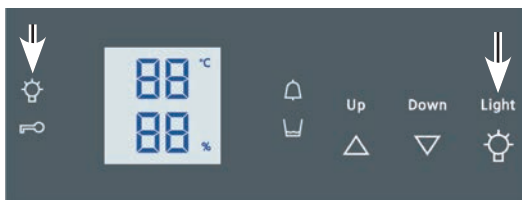

The brightness of the light can also be adjusted.

- Press and hold the Light button and at the same time press the humidity setting buttons to increase or decrease the brightness.



Audible warning signal

The audible warning signal sounds in the event of a malfunction.

It will always sound when the door has been left open for longer than 60 seconds.

It will also sound if the interior becomes too cold or too warm or if the humidity is too high or too low.

The corresponding display will also flash. The  LED will light up.

Stop the signal by pressing the **Alarm** button.



Control elements

 LED lights up when the lighting is operational.

 LED lights up when the child lock is active.

 LED flashes when the temperature or humidity inside the appliance is too high or too low.

 LED lights up when the water tank needs topping up.

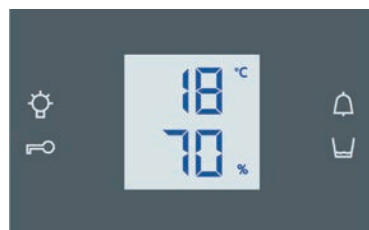

Important!

This alarm will activate when the water level drops to 400 ml (sufficient to allow the appliance to run properly for another 6 weeks). When topping up the water, always remove any impurities such as cigar leaves.

If the water tank is very dirty, clean it and refill with fresh water.

Setup mode

The following functions can be activated in setup mode:

 = Child lock

 = Display brightness

= **Child lock**



The child lock is designed to protect the appliance from being switched off accidentally.

Activating the child lock

- Activate setup mode by pressing the  button for 5 seconds.

- The display reads  

- Press the  button.

- The display reads  



- Press the  button again.

- The  symbol will light up to indicate that the child lock is activated.



- Exit setup mode by pressing the  button.

Deactivating the child lock

- Activate setup mode by pressing the  button for 5 seconds.

- The display reads  

- Press the  button.

- The display reads  



- Press the  button again.

- The  symbol will go out, indicating that the child lock is deactivated.

- Exit setup mode by pressing the  button.

h = Display brightness



Adjusting the display brightness

- Activate setup mode by pressing the ^{Light}  button for 5 seconds.
- Press the ^{Down}  button until h appears in the display.

Press the ^{Light}  button.



- The display reads



- Press the ^{Up}  ^{Down}  buttons and set the brightness between

h 0 = minimum and

h 5 = maximum.

- When you reach the desired level, press the ^{Light}  button.
- Exit setup mode by pressing the ^{On/Off}  button.
- Close the door. The new setting will activate after about 1 minute.

Equipment

Air exchange with activated charcoal filter

To guarantee optimum air throughput, the appliance is fitted with an activated charcoal filter at the top of the rear wall.

We recommend that you replace the illustrated filter once a year. Filters can be obtained from your dealer.

Changing the filter:

The filter can be removed by depressing the recesses on the left and right with a small screwdriver.

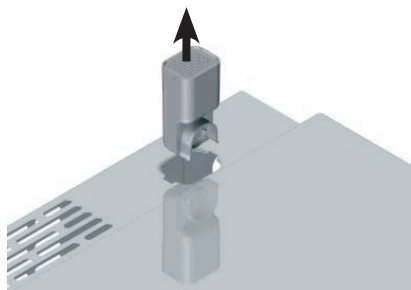

Spanish cedarwood shelves

The presentation boxes are designed for storing cigars individually.

The other shelves are for storing cigars in various containers or boxes.

All shelves are fitted with a pull-out stop and can be pulled out by 100 mm.

To remove completely, pull the shelf out as far as it will go, lift slightly at the front and remove. The door must be open at an angle of at least 90°.

Note: To ensure optimum operation, there must always be at least two cedarwood shelves or boxes inside the appliance, one of which must always be inserted immediately above the control panel.



Alternative interior layouts

The different fitting layouts for optimum cigar storage are illustrated and described below.

Alternative 1

(as supplied)

Use this layout to store large numbers of cigars individually in the presentation boxes and small cigar boxes on the shelves.



Alternative 2

(with top shelf removed)

Use this layout to store large cigar boxes.



Alternative 3

(with both presentation boxes removed)

This layout is only suitable for storing large cigar boxes (see figure).



Important!

1. To ensure constant humidity, there must be at least two pull-out shelves or presentation boxes in the appliance at all times.
2. To ensure adequate air circulation there must always be a shelf or presentation box immediately above the control panel.
3. The pull-out shelves should only be used for storing cigar boxes. Do not use them for storing individual cigars!

Cleaning

Before cleaning, always switch off the appliance. Disconnect from the mains or switch off or unscrew the fuse.

- Remove all cigars from the appliance and store them in a suitable place.
- Remove all shelves and presentation boxes.
- Clean the inside, the door seal and the inside of the glass with a clean, damp cloth.
Important: Never use detergents or other substances that emit odours.
- Always keep the door closed when cleaning the outside of the appliance. Make sure no detergent odours penetrate into the appliance.
- Clean the side panels and door surfaces with a clean and soft cloth. If necessary, use a moist cloth (water + detergent). Alternatively, use a microfibre cloth.

- Fold down the front flap, lift the water tank slightly and remove, as illustrated.

This tray can be washed with water and detergent either manually or in a dishwasher. After cleaning, always make sure the tray is thoroughly rinsed with clean water before replacing.

- Dry the interior and the water tank thoroughly with a clean cloth and replace the water tank.
- Switch the appliance back on and replace the cigars.
- Do not damage the type plate on the back of the appliance. It is very important for servicing purposes.



Safety instructions and warnings

- To prevent injury or damage to the unit, the appliance should be unpacked and set up by two people.
- In the event that the appliance is damaged on delivery, contact the supplier immediately before connecting to the mains.
- To guarantee safe operation, ensure that the appliance is set up and connected as described in these operating instructions.
- Disconnect the appliance from the mains if any fault occurs. Pull out the plug, switch off or remove the fuse.
- When disconnecting the appliance, pull on the plug, not on the cable.
- **Any repairs and work on the appliance should only be carried out by the customer service department, as unauthorised work could prove highly dangerous for the user. The same applies to changing the mains power cable.**
- Do not stand on the plinth, drawers or doors or use them to support anything else.
- This appliance can be used by children of 8 years old and over, and also by persons with restricted physical, sensory or mental capacity or lack of experience and knowledge, if they are supervised or have been instructed on safe use of the appliance and understand the resulting risks. Children must not be allowed to play with the appliance. Cleaning and user maintenance must not be carried out by children without supervision.
- **If you have a lockable appliance, do not keep the key near the appliance or within reach of children.**
- Do not use electrical appliances inside the appliance.
- Do not damage the refrigerant circuit pipes.
- Do not allow naked flames or ignition sources to enter the appliance. When transporting and cleaning the appliance ensure that the refrigerant circuit is not damaged. In the event of damage, make sure that there are no ignition sources nearby and keep the room well ventilated.

The appliance complies with the relevant safety regulations and EU Directives 2014/30/EU and 2014/35/EU.

Disposal notes

The appliance contains reusable materials and should be disposed of properly - not simply with unsorted household refuse. Appliances which are no longer needed must be disposed of in a professional and appropriate way, in accordance with the current local regulations and laws.



When disposing of the appliance, ensure that the refrigerant circuit is not damaged to prevent uncontrolled escape of the refrigerant it contains (data on type plate) and oil.

- Disable the appliance.
- Pull out the mains plug.
- Cut through the connection cable.

WARNING

Danger of suffocation due to packing material and plastic film!

Do not allow children to play with packaging material.

Take the packaging material to an official collection point.

Wall mounting

The appliance can be wall-mounted. There are two mounting holes at the back of the appliance

Make sure the wall and fastenings can withstand the weight of the appliance when fully loaded. The empty appliance weighs 31 kg.

Important!

To ensure sufficient ventilation through the ventilation slots, the four wall spacers must always be inserted, regardless of whether the appliance is wall-mounted or standing on the floor against a wall.

Simply insert the spacers in the openings provided.

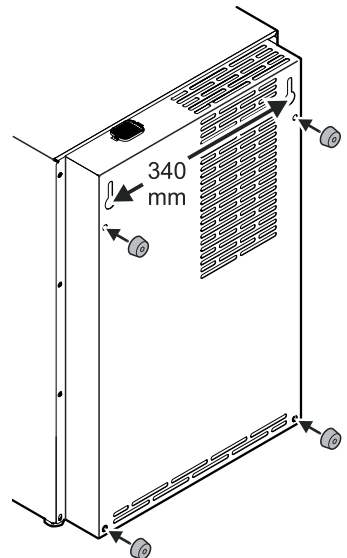

Shutting your appliance down

If your appliance is to be shut down for any length of time, switch it off and disconnect the plug or remove the fuse. Clean the appliance and leave the door open in order to prevent unpleasant smells.

