



User Guide

Quality, Design and Innovation



home.liebherr.com/fridge-manuals









LIEBHERR

Contents

1	Appliance at a glance.....	2
1.1	Scope of delivery.....	2
1.2	Overview of appliances and equipment.....	3
1.3	SmartDevice.....	3
1.4	Appliance range of use.....	4
1.5	Conformity.....	4
1.6	SVHC substances according to REACH regulation.....	4
1.7	EPREL database.....	4
2	General safety instructions.....	4
3	Functionality of the Touch & Swipe display.....	6
3.1	Navigation and symbol explanation.....	6
3.2	Menus.....	6
3.3	Sleep mode.....	7
4	Putting into operation.....	7
4.1	Switching on appliance (first use).....	7
5	Storage.....	7
5.1	Information regarding storage.....	7
5.2	Storage sketches.....	8
6	Saving energy.....	11
7	Controls.....	12
7.1	Control and display elements.....	12
7.1.1	Status display.....	12
7.1.2	Display symbols.....	12
7.1.3	Acoustic signals.....	12
7.2	Appliance functions.....	12
7.2.1	Notes on the appliance functions.....	12
7.2.2	Switching appliance on and off	13
7.2.3	WiFi	13
7.2.4	Temperature	14
7.2.5	Temperature unit	14
7.2.6	SabbathMode	14
7.2.7	HumiditySelect	15
7.2.8	Presentation light	15
7.2.9	Display brightness	16
7.2.10	Door alarm	16
7.2.11	Alarm Sound.....	16
7.2.12	Key Sound.....	17
7.2.13	Display lock	17
7.2.14	Access codes.....	17
7.2.15	Language	19
7.2.16	Device information	19
7.2.17	Software	19
7.2.18	Reminder	20
7.2.19	Demo mode	20
7.2.20	Resetting to factory settings	21
7.3	Message.....	21
7.3.1	Warnings.....	21
7.3.2	Reminders.....	22
8	Features.....	22
8.1	Safety lock.....	22
8.2	Labels.....	23
9	Maintenance.....	23
9.1	Air exchange through the FreshAir activated charcoal filter.....	23
9.2	Cleaning the appliance.....	24
10	Customer help.....	24
10.1	Technical specifications.....	24
10.2	Operating noises.....	25
10.3	Technical fault.....	25
10.4	Customer Service.....	26
10.5	Model plate.....	26
11	Shutting down.....	26
12	Disposal.....	27
12.1	Preparing appliance for disposal.....	27

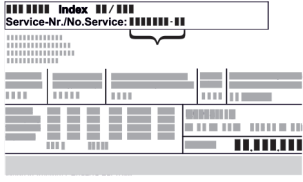
12.2 Disposing of the appliance in an environmentally friendly manner..... 27

The manufacturer is continually working on the further development of all types and models. Please be aware that we reserve the right to make changes to the shape, equipment and technology.

Symbol	Explanation
	Read instructions Please read the information in these instructions carefully to understand all of the benefits of your new appliance.
	Additional information on the Internet The digital manual with additional information and in other languages can be found via the QR code on the front of the manual or by entering the service number at home.liebherr.com/fridge-manuals . The service number can be found on the serial tag:  <i>Fig. Example illustration</i>
	Check appliance Check all parts for transport damage. If you have any complaints, please contact your agent or customer service.
	Differences These instructions apply to a range of models, so differences are possible. Sections that apply to certain models only are marked with an asterisk (*).
	Instructions and results Instructions are marked with a ▶. Results are marked with a ▷.
	Videos Videos about the appliances are available on the YouTube channels of Liebherr-Hausgeräte.

These operating instructions apply to:

WP..	50.. / 52.. / 74..
WS..	52..

1 Appliance at a glance

1.1 Scope of delivery

Check all parts for transport damage. Contact your dealer or customer service in the event of complaints. (see 10.4 Customer Service)

Your new appliance comes with the following parts:

- Standalone appliance
- Features (depending on the model)
- Installation materials (depending on the model)
- “Quick Start Guide”

- "Installation Guide"*
- Service Brochure

1.2 Overview of appliances and equipment

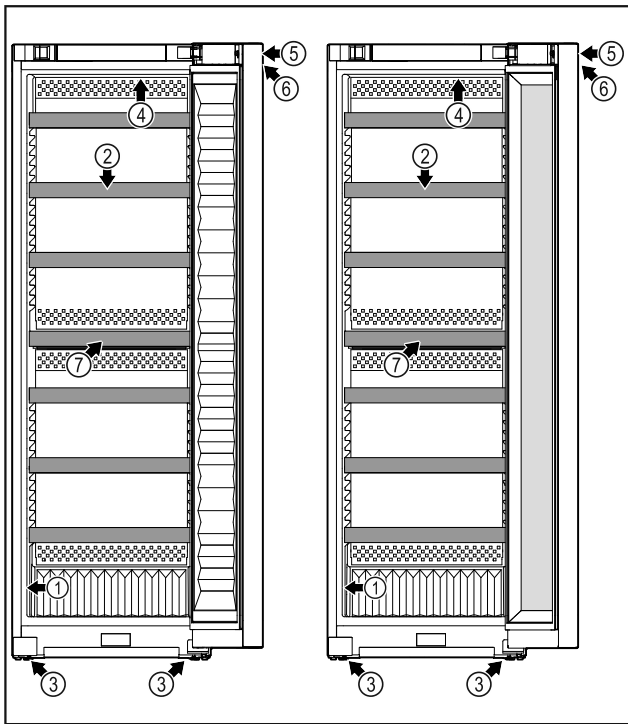

Fig. 1 WP. 50.. / 5252 WS.. 5252

- | | |
|-----------------------|----------------------------------------------|
| (1) Type plate | (5) Lock |
| (2) Wooden grid shelf | (6) Control elements and temperature display |
| (3) Adjustable feet | (7) Activated charcoal filter |
| (4) Interior lighting | |

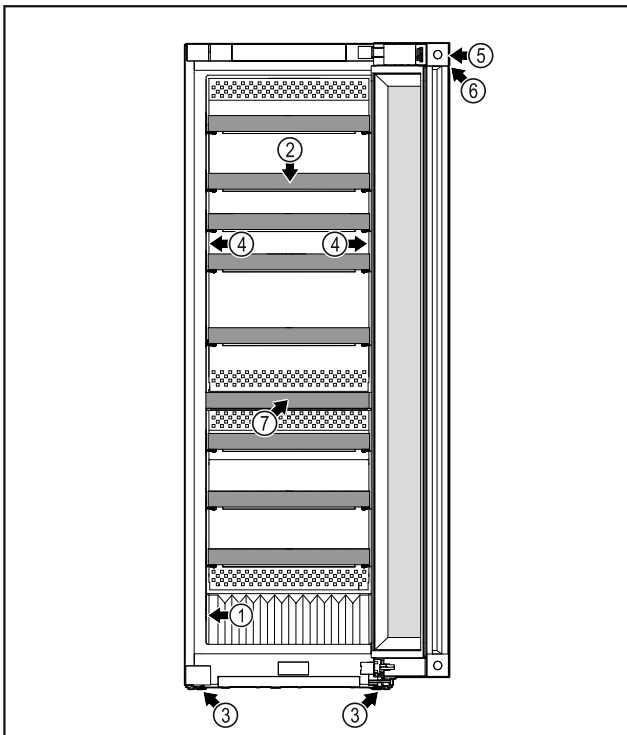

Fig. 2 WP. 5272 / 7472

- | | |
|----------------|----------|
| (1) Type plate | (5) Lock |
|----------------|----------|

- | | |
|-----------------------|----------------------------------------------|
| (2) Wooden grid shelf | (6) Control elements and temperature display |
| (3) Adjustable feet | (7) Activated charcoal filter |
| (4) Interior lighting | |

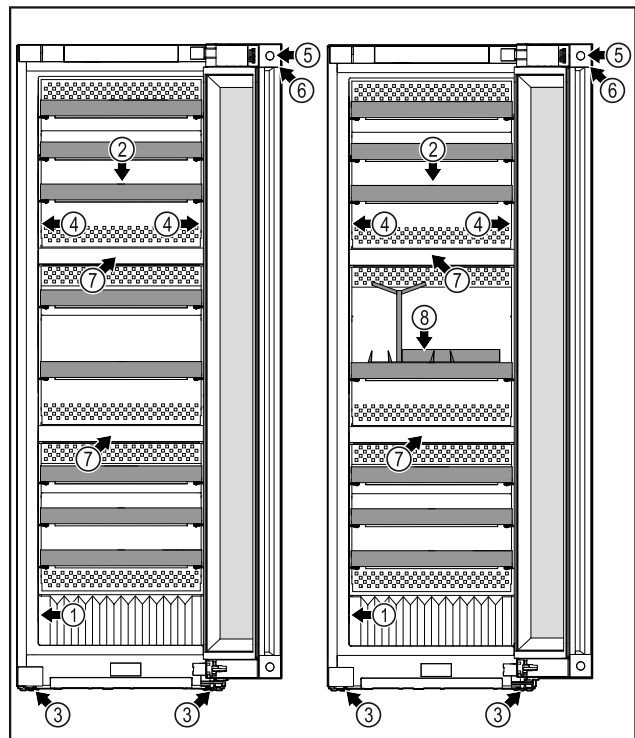

Fig. 3 WP.. 5273 / 7473 WP.. 5283 / 7483

- | | |
|-----------------------|----------------------------------------------|
| (1) Type plate | (5) Lock |
| (2) Wooden grid shelf | (6) Control elements and temperature display |
| (3) Adjustable feet | (7) Activated charcoal filter |
| (4) Interior lighting | (8) Sommelier set* |

1.3 SmartDevice

SmartDevice is the networking solution for your wine storage cabinet.

If your appliance is SmartDevice-enabled or compatible, you can quickly and easily connect your appliance to your WiFi. With the SmartDevice app, you can operate your appliance from a mobile device. Additional functions and setting options are available in the SmartDevice app.

SmartDevice-enabled appliance: Your appliance is capable of being a SmartDevice. To be able to connect your device to WiFi, you need to download the SmartDevice app.



More information about SmartDevice: smartdevice.liebherr.com

General safety instructions

Downloading the SmartDevice app:



After installing and configuring the SmartDevice, you can connect your appliance to the WiFi using the SmartDevice app and the WiFi appliance function (see 7.2.3 WiFi).

Note

The SmartDevice function is not available in the following countries: Russia, Belarus, Kazakhstan.

1.4 Appliance range of use

Intended use

The appliance is only suitable for storing wine in a domestic or domestic-like environment. This includes, for example, using

- in staff kitchens, bed and breakfast establishments,
- by guests in country houses, hotels, motels and other accommodation,
- for catering and similar services in the wholesale trade.

The appliance is not suitable for freezing food;

The appliance is not suitable as a built-in unit.

All other types of use are not permitted.

Foreseeable misuse

The following applications are expressly forbidden:

- Storing and refrigerating medicines, blood plasma, laboratory preparations or similar substances and products based on the Medical Device Directive 2007/47/EC
- Use in areas at risk of explosions

Misusing the appliance may lead to damage to the goods stored or they may spoil.

Climate classifications

Depending on the climate classification the appliance is designed to operate in restricted ambient temperatures. The climate classification applying to your appliance is printed on the rating plate.

Note

- Keep to the specified ambient temperatures in order to guarantee that the appliance works properly.

Climate classification	for ambient temperatures of
SN	10 °C to 32 °C
N	16 °C to 32 °C
ST	16 °C to 38 °C
T	16 °C to 43 °C
SN-ST	10 °C to 38 °C
SN-T	10 °C to 43 °C

1.5 Conformity

The refrigerant circuit has been tested for leaks. The appliance complies with the applicable safety regulations and with the corresponding directives.

For the EU market: The appliance complies with directive 2014/53/EU.

For the GB market: The appliance complies with Radio Equipment Regulations 2017 SI 2017 No. 1206.

The full text of the EU Declaration of Conformity is available on the following website: www.Liebherr.com

Since there are no energy efficiency guidelines for wine cooling appliances, wine compartments are considered to be cellar compartments for assignment to an energy efficiency class.

1.6 SVHC substances according to REACH regulation

You can check whether your appliance contains SVHC substances according to REACH regulation at the following link: home.liebherr.com/de/deu/de/liebherr-erleben/nachhaltigkeit/umwelt/scip/scip.html

1.7 EPREL database

Details about energy labelling and ecodesign requirements will be available on the European product database (EPREL) from 1st March 2021. You can access the product database at the following link: <https://eprel.ec.europa.eu/> You will be asked to enter the model ID. You can find the model ID on the nameplate.

2 General safety instructions

Please keep these operating instructions in a safe place so you can refer back to them at any time.

If you pass the appliance on, please hand these operating instructions to the next user.

Read these operating instructions carefully before use to ensure safe and correct use of the appliance. Follow the instructions, safety instructions and warning messages included at all times. They are important for ensuring you can operate and install the appliance safely and without any problems.

Danger for the user:

- This device can be used by children and people with impaired physical, sensory or mental abilities or with a lack of experience and knowledge provided that they are supervised or have received instruction in the safe use of this device, and about the resulting hazards.
Children must not play with this appliance. Cleaning and user maintenance work must not be carried out by children without adult supervision. Children aged between 3 and 8 are allowed to load and unload the appliance. Children below the age of 3 must be kept away from the appliance unless they are under continuous adult supervision.
- The socket must be easily accessible so that the appliance can be disconnected quickly from the electricity in an emergency. It must not be located in the area behind the appliance.
- When disconnecting the appliance from the supply, always take hold of the plug. Do not pull the cable.
- In the event of a fault pull out the mains plug or deactivate the fuse.
- Do not damage the mains power cable. Do not operate the appliance with a defective mains power cable.
- Only customer service or other specially trained staff may repair or perform other operations on the appliance.
- Only assemble, connect and dispose of the appliance according to the instructions.

Fire hazard:

- The coolant used (information on the model plate) is ecofriendly but also flammable. Any leaking coolant may ignite.
 - Do not damage the refrigerant circuit pipes.
 - Do not handle ignition sources inside the appliance.
 - Do not use electrical appliances inside the appliance (e.g. steam cleaners, heaters, ice cream makers, etc.).
 - If the refrigerant leaks: remove any naked flames or ignition sources from the vicinity of the leakage point. Properly air the room. Inform customer services.
- Do not store explosives or sprays using combustible propellants such as butane, propane, pentane, etc. in the appliance. To identify these spray cans, look for the list of contents printed on the can, or a flame symbol. Gases possibly escaping may ignite due to electrical components.

- Keep burning candles, lamps and other items with naked flames away from the appliance so that they do not set the appliance on fire.

- Please be sure to store alcoholic drinks or other packaging containing alcohol in tightly closed containers. Any alcohol that leaks out may be ignited by electrical components.

Danger of tipping and falling:

- Do not misuse the plinth, drawers, doors etc. as a step or for support. This applies particularly to children.

Danger of food poisoning:

- Do not consume food which has been stored too long.

Danger of frostbite, numbness and pain:

- Avoid prolonged skin contact with cold surfaces or refrigerated/frozen goods or take protective measures, e.g wear gloves.

Danger of injury and damage:

- Hot steam can lead to injury. Do not use electrical heating or steam cleaning equipment, open flames or defrosting sprays to defrost.
- Do not use sharp implements to remove the ice.

Risk of crushing:

- Do not hold the hinge when opening and closing the door. Fingers may get caught.

Symbols on the appliance:



This symbol may be located on the compressor. It relates to the oil in the compressor and makes reference to the risk that: Swallowing or inhaling can be fatal. This advice is only relevant to recycling. There is no danger in normal operation.



This symbol is located on the compressor and indicates the danger of flammable materials. Do not remove the sticker.





This or a similar sticker may be located on the rear of the appliance. This sticker indicates that there are vacuum insulation panels (VIP) or perlite panels in the door and/or housing. This advice is only relevant to recycling. Do not remove the sticker.

Please note the warning messages and other specific advice in the other chapters:

	DANGER	indicates an immediately hazardous situation which will lead to death or serious injuries if it is not avoided.
--	--------	-----------------------------------------------------------------------------------------------------------------

Functionality of the Touch & Swipe display







	WARNING	indicates a hazardous situation which may lead to death or serious injuries if it is not avoided.
	CAUTION	indicates a hazardous situation which may lead to minor or moderate injuries if it is not avoided.
	NOTICE	indicates a hazardous situation which may lead to damage to property if it is not avoided.
	Note	indicates useful instructions and tips.

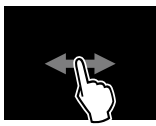

3 Functionality of the Touch & Swipe display

You operate your appliance using the Touch & Swipe display. You select appliance functions in the Touch & Swipe display (hereafter referred to as display) by tapping them. If you do not perform any action on the display for 10 seconds, the display either jumps back to the higher-level menu or directly to the status display.

3.1 Navigation and symbol explanation

In the illustrations, different symbols are used to navigate the display. The following table describes these symbols.

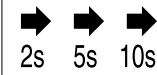

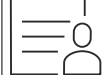
Symbol	Description
	Briefly touch the display: Activates/deactivates function. Confirms selection. Opens submenu.
	Touch the display for a specified time (e.g. 3 seconds): Activates/deactivates function or value.
	Swipe left or right: Navigate in the menu.
	Briefly touch the Back symbol: Jumps back one menu level.
	Press and hold the Back symbol for 3 seconds: Jumps back to the status display.
	Briefly touch the Back symbol at the top left: Jumps back one menu level.
	Arrow with clock: It takes more than 10 seconds for the following message to appear in the display.

Symbol	Description
	Arrow with a time indication: It takes the specified amount of time until the following message appears in the display.
	“Open Settings menu” symbol: Navigates to the Settings menu and opens the settings menu. If necessary: Navigate to the desired function in the Settings menu. (see 3.2.1 Opening the Settings menu)
	“Open Advanced menu” symbol: Navigates to the Advanced menu and opens the advanced menu. If necessary: Navigate to the desired function in the Advanced menu. (see 3.2.2 Opening the expanded menu)
No action for 10 seconds	If you do not perform any action on the display for 10 seconds, the display either jumps back to the higher-level menu or directly to the status display.
Open door and close it again.	If you open the door and immediately close it again, the display jumps directly back to the status display.

Note: Illustrations of the display are shown in the English version.

3.2 Menus

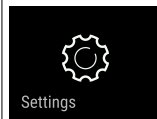
The appliance functions are distributed over various menus:

Menu	Description
Main menu	When you switch the appliance on, you are automatically in the main menu. From here you can navigate to the most important appliance functions, to the Settings menu and to the Advanced menu.
 Settings menu	The Settings menu contains additional appliance functions for setting up your appliance.
 Advanced menu	The advanced menu contains special appliance functions for setting up your appliance. Access to the Advanced menu is protected by the numerical code 1 5 1 .

3.2.1 Opening the Settings menu

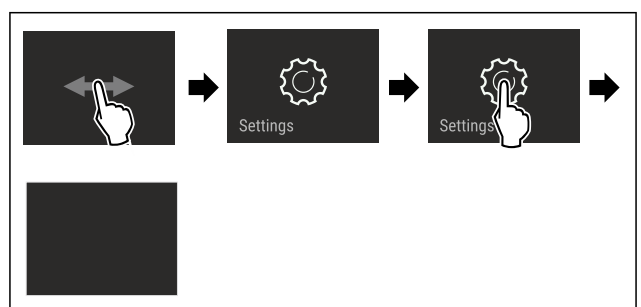

Fig. 4 Example illustration

- ▶ Carry out action steps according to the illustration.
- ▷ Settings menu is open.
- ▶ If necessary: Navigate to the desired function.

3.2.2 Opening the expanded menu

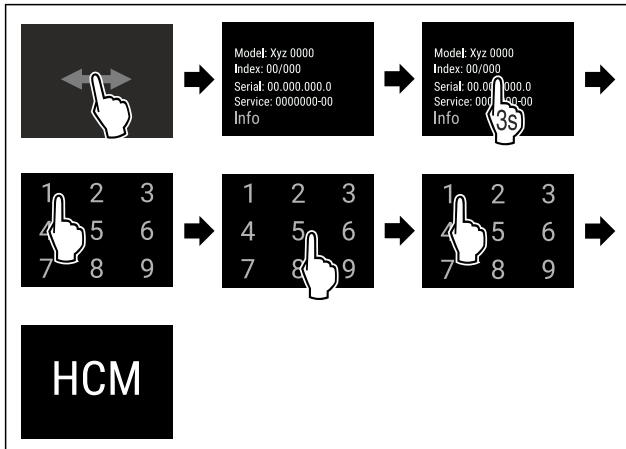

Fig. 5 Access with numerical code **151**

- ▶ Carry out action steps according to the illustration.
- ▷ The expanded menu is open.
- ▶ If necessary: Navigate to the desired function.

3.3 Sleep mode

If you do not touch the display for 1 minute, the display switches to sleep mode. In sleep mode, the display brightness is dimmed.

3.3.1 Ending sleep mode

- ▶ Touch the display briefly with your finger.
- ▷ Sleep mode is ended.

4 Putting into operation

4.1 Switching on appliance (first use)

Ensure that the following requirements are met:

- Appliance is installed and connected.
- All adhesive strips, adhesive and protective films and transport locks are removed from inside and outside the appliance.

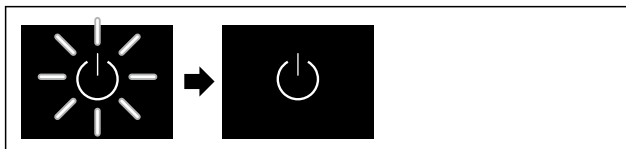

Fig. 6 Example illustration

- ▶ The standby symbol is flashing: Wait until the start process is complete.
- ▷ The display shows the standby symbol.

If the appliance has been supplied with factory settings, the screen language and the date/time first need to be set when using the appliance for the first time.

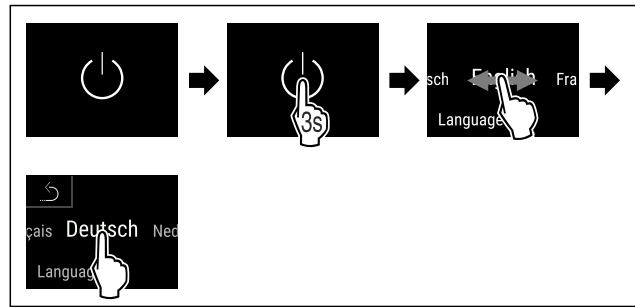

Fig. 7

- ▶ Carry out action steps according to the illustration.
- ▷ Language is set.



Fig. 9 Status display

- ▷ The appliance is ready for operation once the temperature appears in the display.
- ▷ The temperature display flashes until the set temperature is reached.

5 Storage

5.1 Information regarding storage



WARNING

Risk of fire

- ▶ Do not use any electrical appliances in the food area of the appliance unless recommended by the manufacturer.

Note

The energy consumption increases and the cooling power goes down if ventilation is not sufficient.

- ▶ Always keep air slots clear.

Observe the following specifications for storage:

- Keep liquids in closed containers.
- Position storage shelves according to the height required.
- Observe maximum load weight. (see 10.1 Technical specifications)

Storage

Temperature zone	Food	
VarioTempZone	Store food according to the set temperature. Liebherr recommends storing food in the VarioTempZone:	
	Temperature range	Food
	4 °C to 9 °C	ready prepared food, cheese, tinned food
	0 °C	packaged fruit and vegetables
	-2 °C	fresh fish and seafood
	10 °C to 14 °C	cold-sensitive foods such as sweet potato, pumpkin or tropical fruits, foods or drinks that should not be too cold when consumed
-18 °C	see freezer section	

VarioTempZone overview

5.2 Storage sketches

5.2.1 WP.. 5052

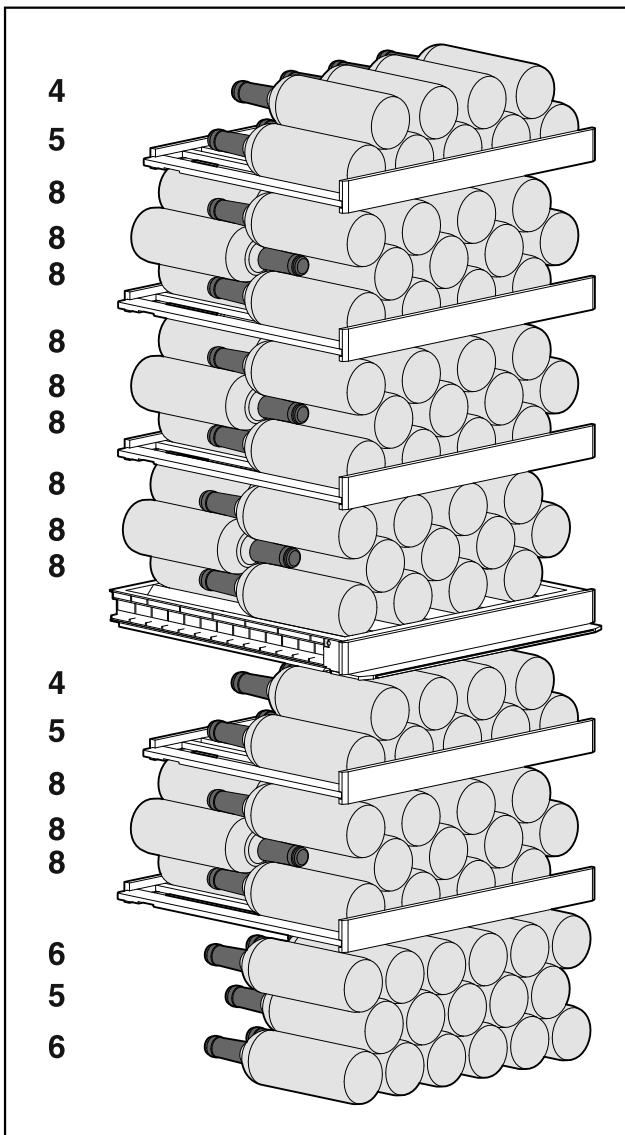

Fig. 10 Total of 131 bottles (for 0.75 l Bordeaux bottles)

5.2.2 WP / WS 5252

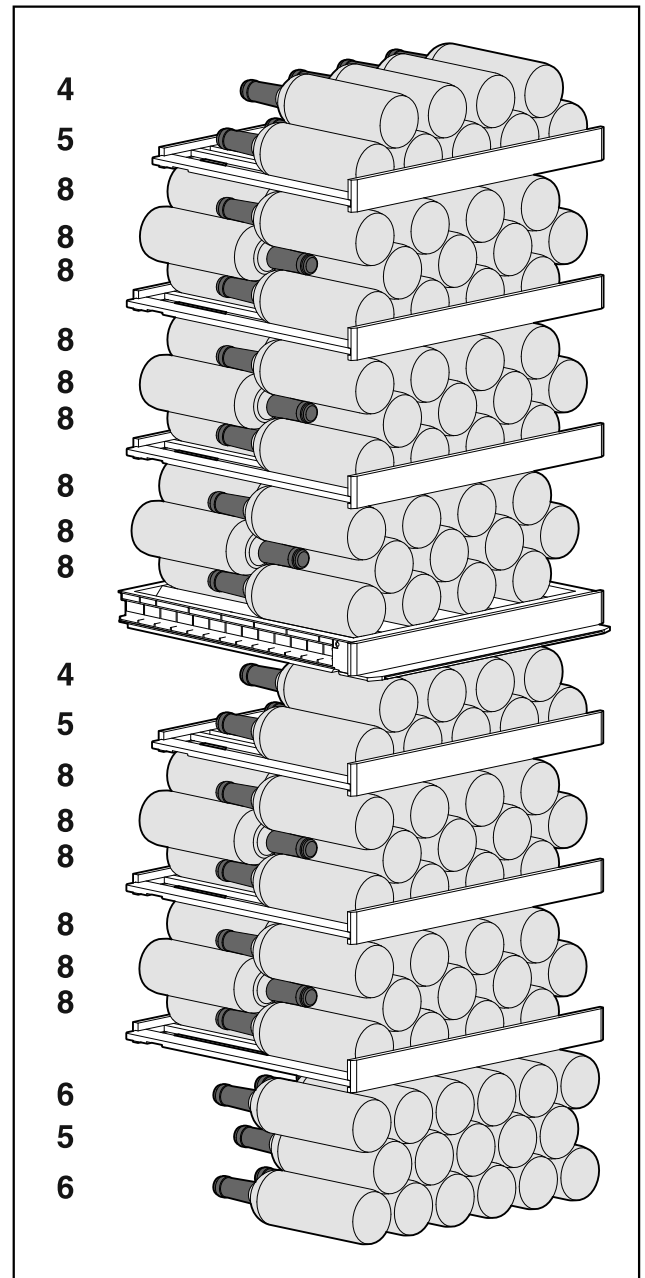

Fig. 11 Total of 155 bottles (for 0.75 l Bordeaux bottles)

5.2.3 WP.. 5272

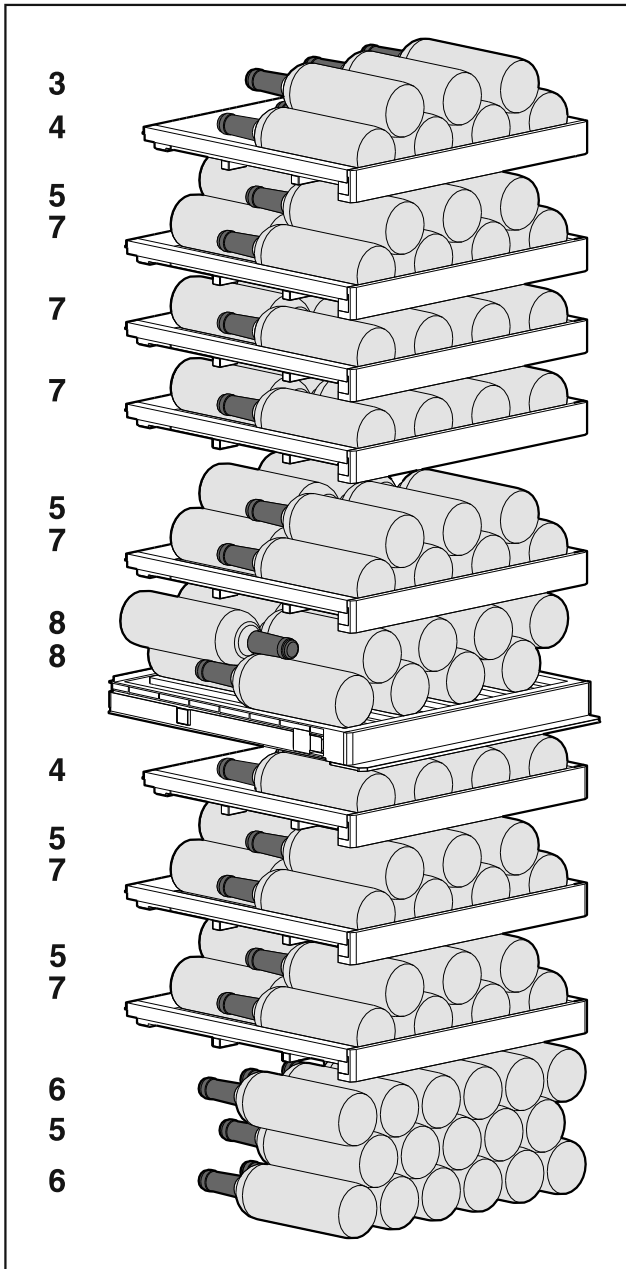

Fig. 12 Total of 106 bottles (for 0.75 l Bordeaux bottles)

5.2.4 WP.. 5273

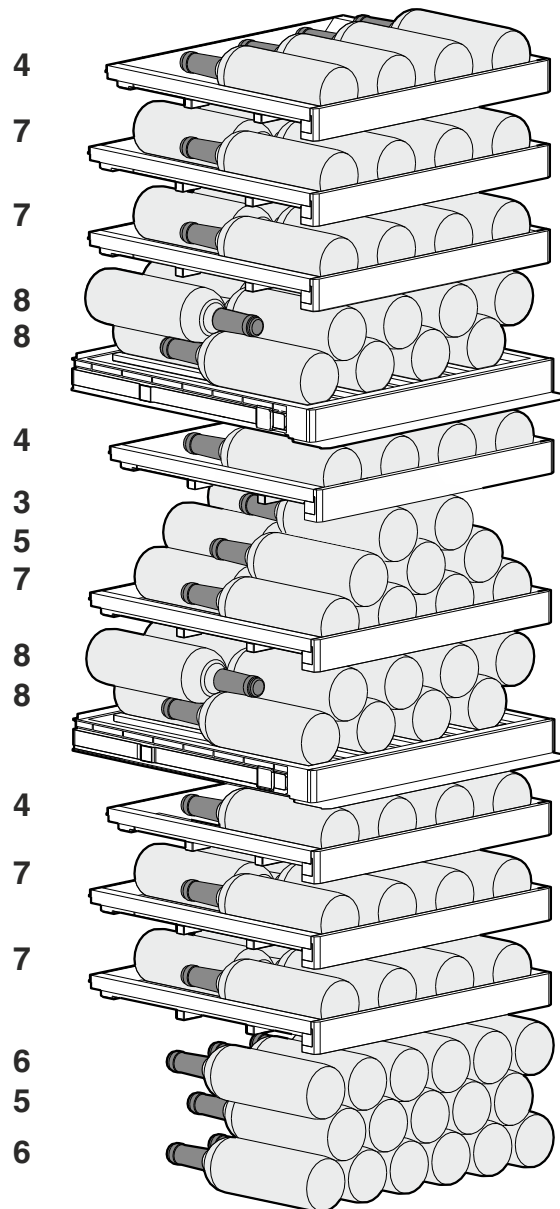

Fig. 13 Total of 104 bottles (for 0.75 l Bordeaux bottles)

Storage

5.2.5 WP.. 5283

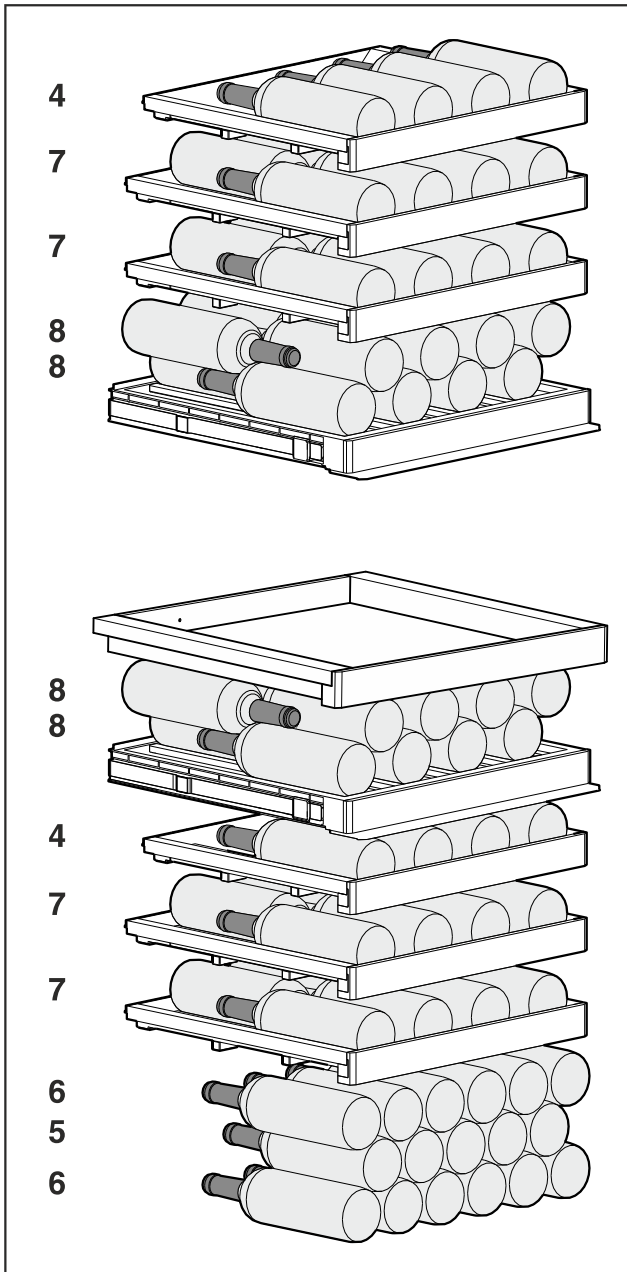

Fig. 14 Total of 85 bottles (for 0.75 l Bordeaux bottles)

5.2.6 WP.. 7473

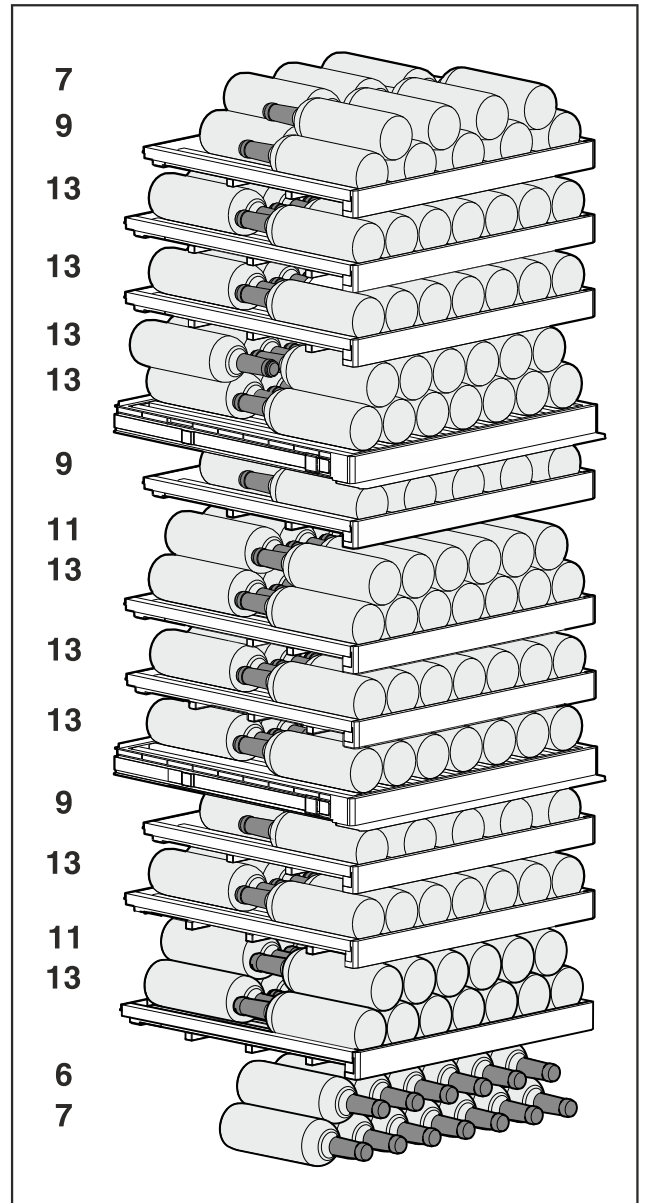

Fig. 15 Total of 182 bottles (for 0.75 l Bordeaux bottles)

5.2.7 WP.. 7472

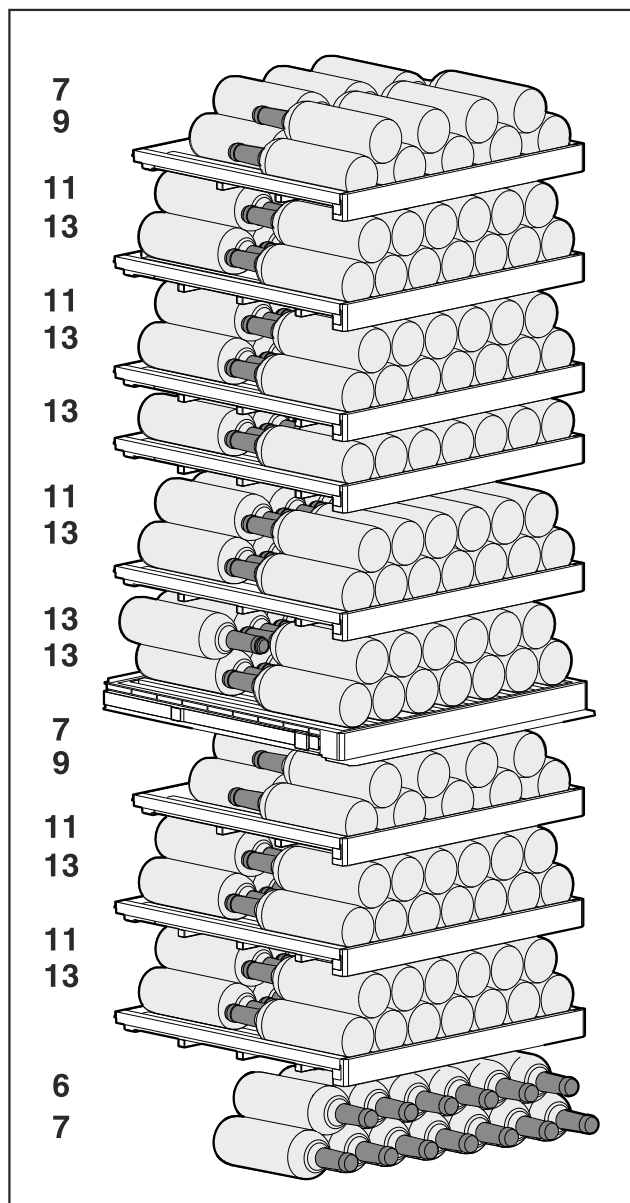

Fig. 16 Total of 204 bottles (for 0.75 l Bordeaux bottles)

5.2.8 WP.. 7483

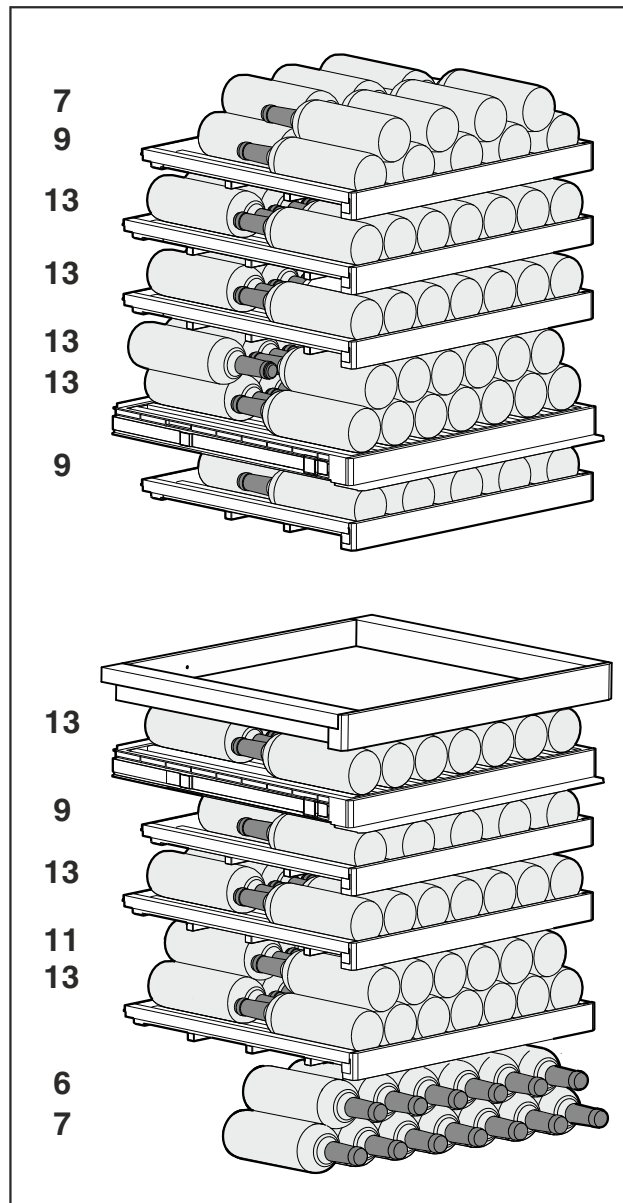

Fig. 17 Total of 149 bottles (for 0.75 l Bordeaux bottles)

6 Saving energy

- Pay attention to good ventilation. Do not cover ventilation holes or grids.
- Always keep the fan air slits clear.
- Do not place the appliance in direct sunlight or near radiators or similar sources of heat.
- If the appliance is placed directly next to an oven, the energy consumption may increase slightly. This is dependent on the service life and usage intensity of the oven.
- Energy consumption depends on the installation conditions, e.g. the ambient temperature (see 1.4 Appliance range of use) . A warmer ambient temperature can increase the energy consumption.
- Open the appliance for as short a time as possible.
- The lower the temperature is set the higher the energy consumption.

7 Controls

7.1 Control and display elements

The display provides a quick overview of the current appliance status, the temperature setting, the status of functions and settings as well as alarm and error messages.

Operation takes place directly on the Touch & Swipe display by swiping and touching.

Functions can be activated or deactivated and setting values can be changed.

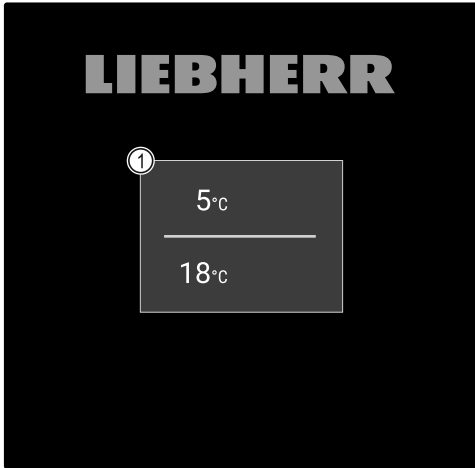

Fig. 18 Touch & Swipe display*
(1) Status display



Fig. 19 Touch & Swipe display*
(1) Status display

7.1.1 Status display



Fig. 20 Status display*
(1) Temperature

The status display is the output display.

Navigation to the functions takes place from the status display.

7.1.2 Display symbols

Display symbols provide information about the status of the appliance.

Symbol	Appliance status
	Standby symbol Appliance is switched off.
	Standby symbol (flashing) Appliance is starting up.
	Temperature (flashing) Target temperature not yet reached. Appliance cooling to temperature set.
	Status display (white frame) Appliance is locked.
	D in the display The appliance is in demo mode.
	Manual door opening (yellow) The locked door was opened manually.
	Error symbol (red) Appliance is in error state.
	Background (blue) Active setting or active function
	Bar (increasing) Press for 3 seconds to activate setting.
	Bar (decreasing) Press for 3 seconds to deactivate setting.

Symbols on the status display

7.1.3 Acoustic signals

A signal sounds in the following cases:

- If a function or a value is confirmed.
- If a function or a value can either not be activated or not deactivated.
- As soon as an error occurs.
- If there is an alarm message.

The alarms can be switched on and off in the customer menu.

7.2 Appliance functions

7.2.1 Notes on the appliance functions

The appliance functions are set at the factory so that your appliance is fully functional.

Before you alter, activate or deactivate the device functions, make sure that the following requirements are met:

- You have read and understood the descriptions of how the display works. (see 3 Functionality of the Touch & Swipe display)
- You have familiarised yourself with the operating and display elements of your appliance. (see 7.1 Control and display elements)

7.2.2 Switching appliance on and off



This function makes it possible to switch the entire appliance on and off.

Switching on appliance

If demo mode is not activated:

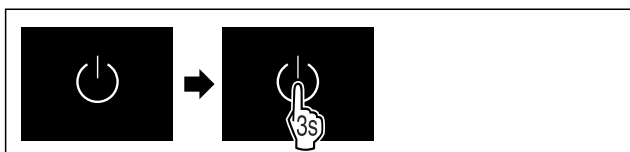

Fig. 21

- ▶ Carry out action steps according to the illustration.

If demo mode is activated:

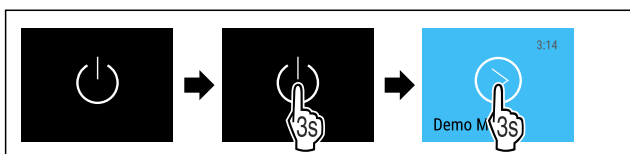

Fig. 22

- ▶ Carry out action steps according to the illustration.

Note

Deactivate demo mode before the countdown has finished.

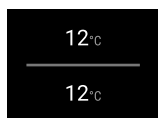

Fig. 24 Status display

- ▷ The temperature appears in the display.

Switching off appliance



Fig. 25

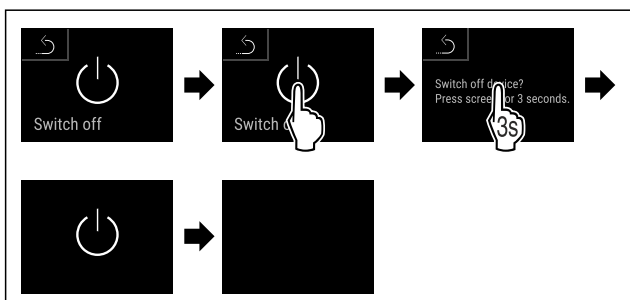

Fig. 26

- ▶ Carry out action steps according to the illustration.
- ▷ Standby symbol is shown in the display.
- ▷ The display switches off automatically after around 10 minutes.

7.2.3 WiFi



Use this function to connect your appliance to WiFi. You can then operate it via the SmartDevice app on a mobile device. You can also use this function to disconnect or reset the WiFi connection.

More information on the SmartDevice: (see 1.3 SmartDevice)

Note

The SmartDevice function is not available in the following countries: Russia, Belarus, Kazakhstan.

Establishing the WiFi connection for the first time

Make sure that the following requirements are fulfilled:

- You have installed the SmartDevice app (see apps.home.liebherr.com).
- Registration in the SmartDevice app is completed.



Fig. 27

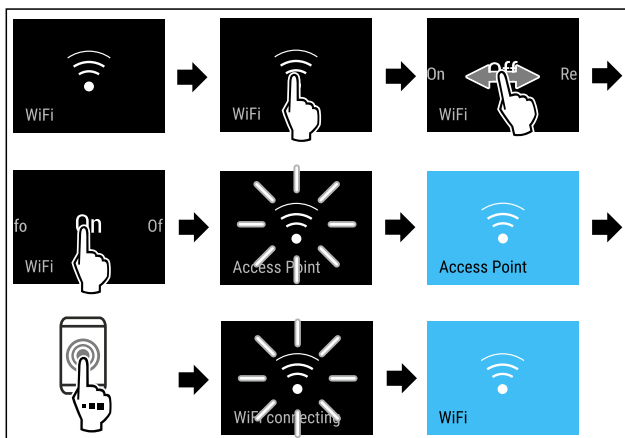

Fig. 28

- ▶ Carry out action steps according to the illustration.
- ▷ Connection is established.

Disconnecting from the WiFi



Fig. 29

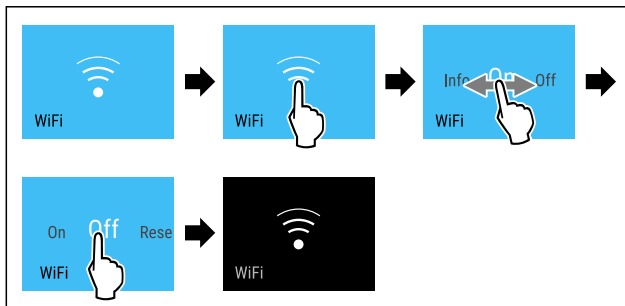

Fig. 30

- ▶ Carry out action steps according to the illustration.
- ▷ There is no connection.

Controls

Resetting the WiFi connection



Fig. 31

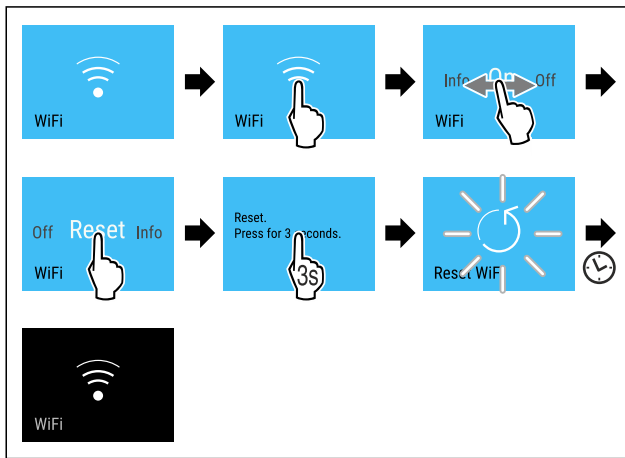

Fig. 32

- ▶ Carry out action steps according to the illustration.
- ▷ WiFi connection and other WiFi settings are reset to factory settings.

Showing information about the WiFi connection



Fig. 33

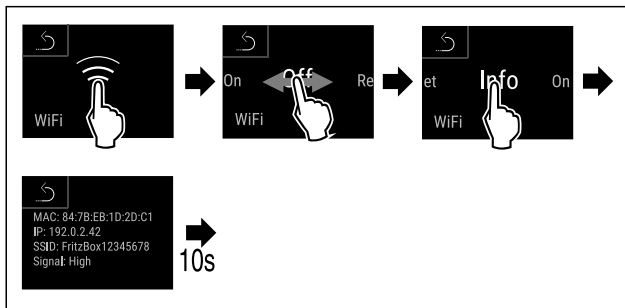

Fig. 34

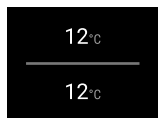

Fig. 35 Status display

- ▶ Carry out action steps according to the illustration.

7.2.4 Temperature



The temperature depends on the following factors:

- How often the door is opened
- How long the door is open for
- The room temperature of the installation site
- The type, temperature and amount of refrigerated food

Note

The temperature may differ from the temperature displayed in some areas of the interior.

At the correct temperature, cooled produce will keep for longer. This avoids disposing of food unnecessarily.

Setting temperature

The following steps describe how to increase the temperature, e.g. from 5 °C to 10 °C.

- ▶ Tap the temperature of the desired zone.

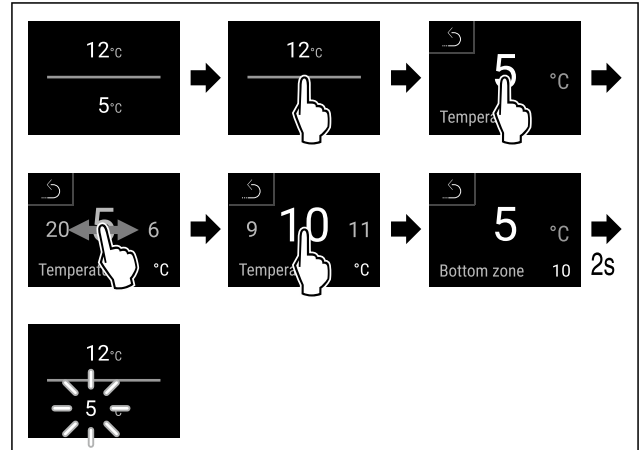

Fig. 36 *

- ▶ Carry out action steps according to the illustration.
- ▷ Temperature is set.

7.2.5 Temperature unit



Use this function to set the temperature unit. You can set degrees Celsius or degrees Fahrenheit as the temperature unit.

Setting the temperature unit



Fig. 37

- ▶ Carry out action steps according to the illustration.
- ▷ The temperature unit is set.

7.2.6 SabbathMode



You can use this function to activate or deactivate SabbathMode. If you activate this function, some electronic functions are switched off. As a result, your device meets the religious requirements for Jewish holidays such as Sabbath and complies with STAR-K Kosher certification.

Device status when SabbathMode is active
The status display shows SabbathMode permanently.
All functions on the display are locked except for the Deactivate SabbathMode function .
Active functions remain active.
The display remains bright when you close the door.
The interior lighting is deactivated.
Reminders are not implemented. The set time interval stops.

Device status when SabbathMode is active
Reminders and warnings are not displayed.
There is no door alarm.
There is no temperature alarm.
After a power failure, the appliance returns to SabbathMode.

Device status

Note

This appliance has certification from the "Institute for Science and Halacha". (www.machonhalacha.co.il)

You can find a list of STAR-K-certified appliances at www.star-k.org/appliances.

Activating SabbathMode



Fig. 39

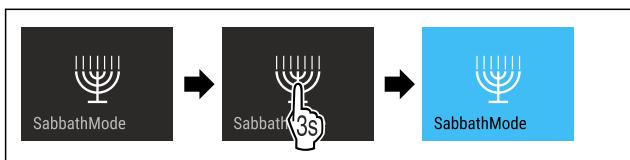

Fig. 40

- ▶ Carry out action steps according to the illustration.
- ▷ SabbathMode is activated.
- ▷ The status display shows SabbathMode permanently.

Deactivating SabbathMode

The SabbathMode is automatically deactivated after 80 hours. However, you can also deactivate SabbathMode manually at any time:

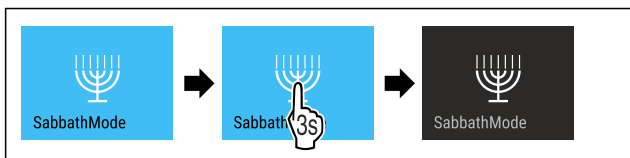
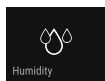

Fig. 41

- ▶ Carry out action steps according to the illustration.
- ▷ SabbathMode is deactivated.
- ▷ Door is locked automatically.

7.2.7 HumiditySelect



Use this function to set the humidity inside your appliance. Setting the humidity correctly will have a positive effect on the structure of the corks during long-term storage and prevent them from drying out.

Note

The frequency and duration for which the door is open influence the humidity in the appliance.

You can choose between two humidity settings:

HumiditySelect function	Temperature setting on the appliance	Application/energy consumption
Standard (preset)	10-12 °C	average humidity in the environment between 50-80% low energy consumption of the appliance
High	10-12 °C	average humidity in the environment < 50% energy consumption of the appliance increases

Increasing the humidity in the appliance



Fig. 42

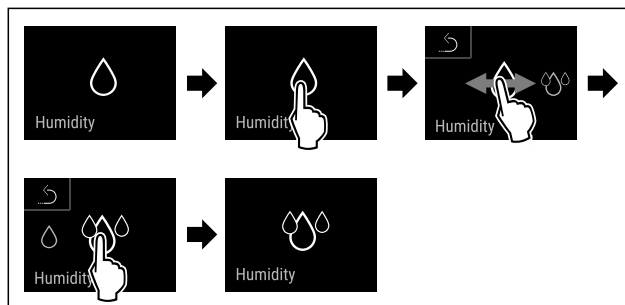

Fig. 43

- ▶ Carry out action steps according to the illustration.
- ▷ Humidity in the appliance increases.

Setting the humidity in the appliance to standard



Fig. 44

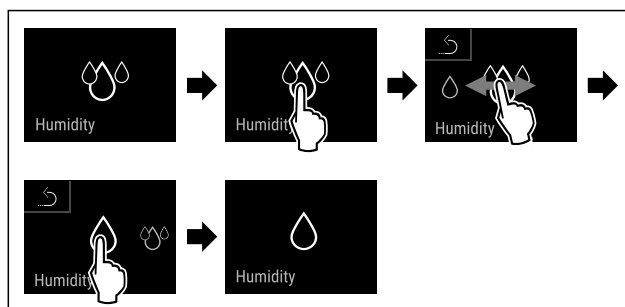

Fig. 45

- ▶ Carry out action steps according to the illustration.
- ▷ Humidity in the appliance decreases.

7.2.8 Presentation light



This setting allows the presentation light to be adjusted incrementally.

Controls

The following brightness values can be set:

- Off
- 20%
- 40%
- 60%
- 80%
- 100% (default)

Adjusting the presentation light

The following steps describe how to reduce the brightness of the presentation light, e.g. from 100 % to 40 %.



Fig. 46

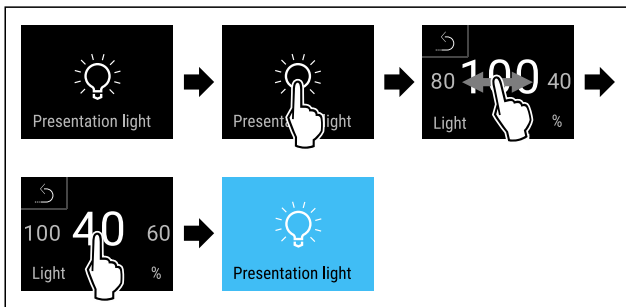

Fig. 47

- ▶ Carry out action steps according to the illustration.
- ▷ The brightness of the presentation light changes accordingly.

7.2.9 Display brightness



Use this function to set the display brightness in stages.

You can select the following brightness levels:

- 20 %
- 40 %
- 60 %
- 80 %
- 100 % (pre-setting)

Setting the brightness



Fig. 48

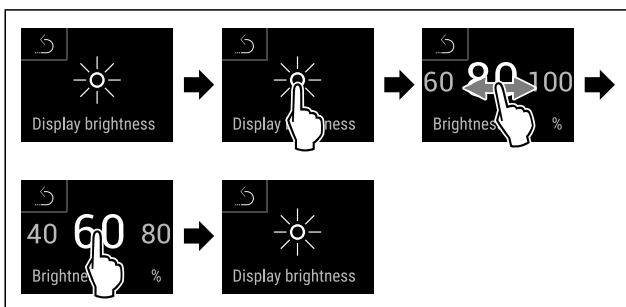

Fig. 49 Example illustration: Switch from 80 % to 60 %.

- ▶ Carry out action steps according to the illustration.
- ▷ The brightness is set.

7.2.10 Door alarm



Use this function to activate or deactivate the door alarm. The door alarm sounds if the door is open for too long. The door alarm is activated on delivery. You can set how long the door may be open before the door alarm sounds.

The following values can be set:

- 1 minute
- 2 minutes
- 3 minutes
- Off

Setting the door alarm



Fig. 50

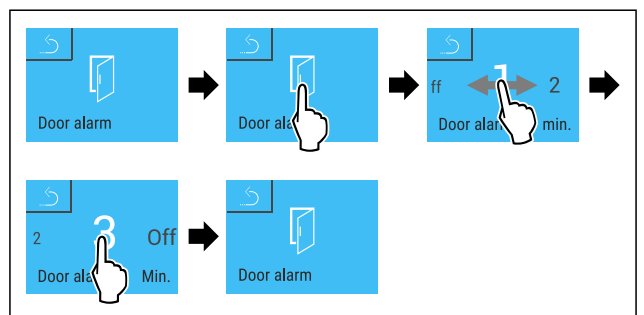

Fig. 51 Example illustration: Change door alarm from 1 minute to 3 minutes.

- ▶ Carry out action steps according to the illustration.
- ▷ The door alarm is set.

Deactivating the door alarm



Fig. 53

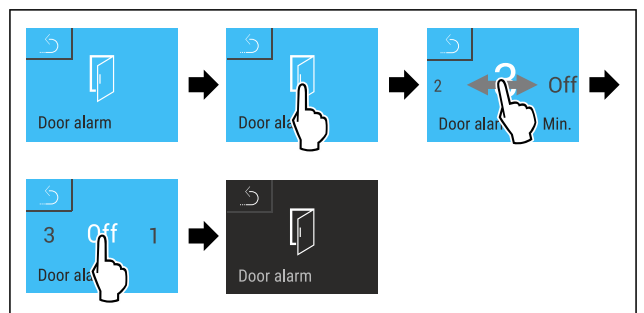

Fig. 54

- ▶ Carry out action steps according to the illustration.
- ▷ The door alarm is deactivated.

7.2.11 Alarm Sound



This function enables all alarm sounds, such as door alarms, to be switched on and off.

Activating Alarm Sound



Fig. 55

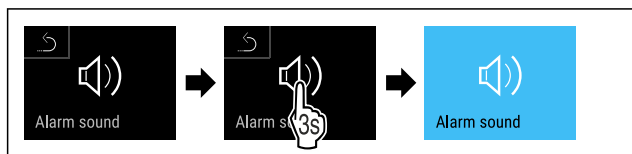

Fig. 56

- ▶ Carry out action steps according to the illustration.
- ▷ Alarm Sound is activated.

Deactivating Alarm Sound



Fig. 57

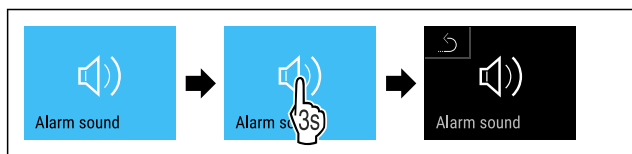

Fig. 58

- ▶ Carry out action steps according to the illustration.
- ▷ Alarm Sound is deactivated.

7.2.12 Key Sound



This function makes it possible to switch all button sounds, confirmation sounds, and the startup sound on and off.

Activating Key Sound



Fig. 59

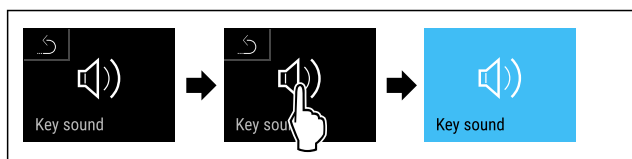

Fig. 60

- ▶ Carry out action steps according to the illustration.
- ▷ Key Sound is activated.

Deactivating Key Sound



Fig. 61

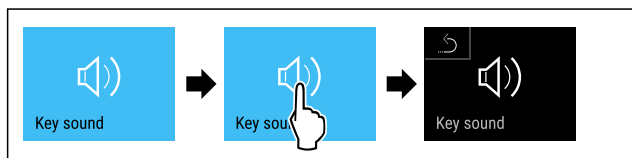

Fig. 62

- ▶ Carry out action steps according to the illustration.
- ▷ Key Sound is deactivated.

7.2.13 Display lock



This setting avoids accidental operation of the appliance.

Application:

- Prevent settings and functions being changed unintentionally.
- Prevent appliance being switched off unintentionally.
- Prevent temperature being set unintentionally.

Note

Despite the display lock being activated, the door lock can be opened and locked at any time using the PIN code (see 7.2.14 Access codes).

Activating display lock



Fig. 63

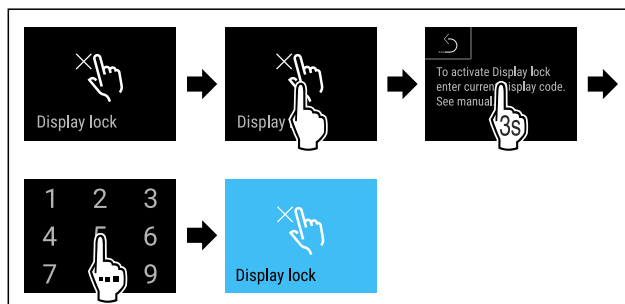

Fig. 64

- ▶ Carry out action steps according to the illustration.
- ▷ The display lock is activated.
- ▷ The status display appears.

Unlocking the display for a short time

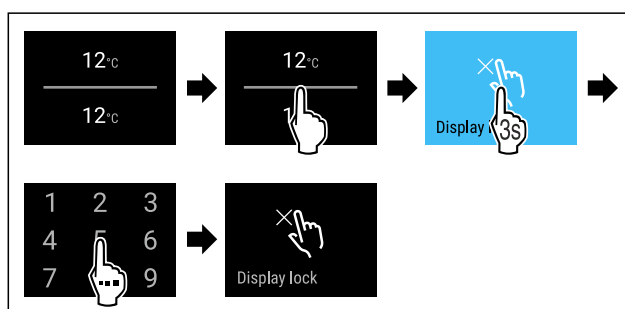

Fig. 65*

- ▶ Carry out action steps according to the illustration.
- ▷ The display lock is deactivated.
- ▷ The status display appears.

7.2.14 Access codes

Various settings are possible.

Application:

- Changing the door code.
- Resetting the door code.
- Changing the display lock code.
- Resetting the display lock code.

Controls



Door code

Changing door code

The setting allows the door code for the door lock to be changed.

The setting is made in three stages:

- Entering the old door code
- Entering the new door code
- Confirming the new door code

Note

- ▶ In the following example, the default factory set door code **1 1 1 1** is changed.
- ▶ The new door code is: **2 3 4 5**



Fig. 66

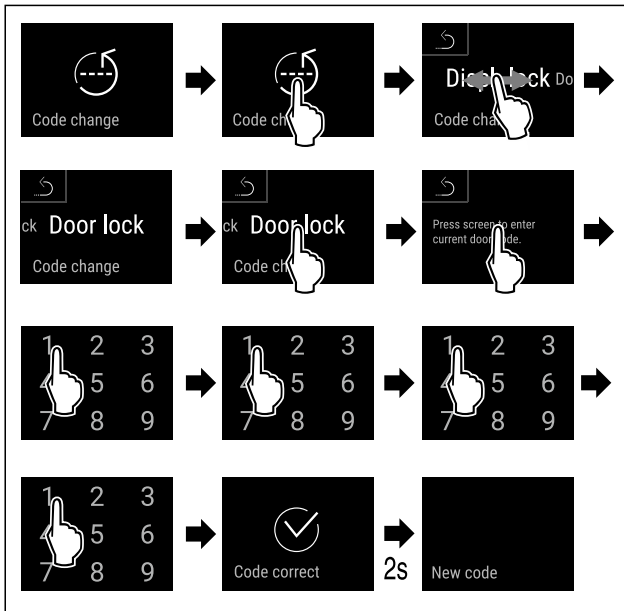

Fig. 67

- ▶ Carry out action steps according to the illustration.
- ▷ Entry of the old door code successful.

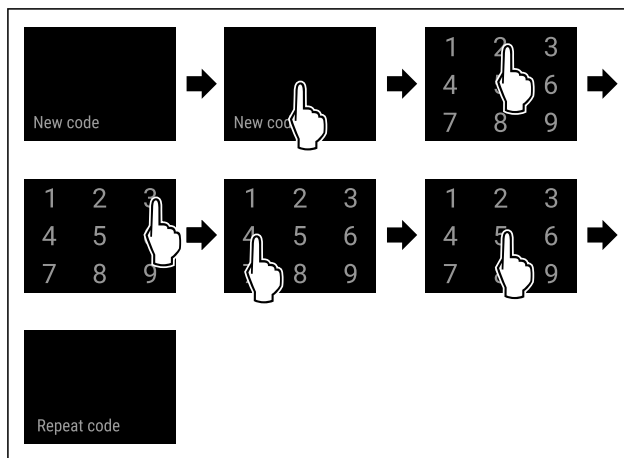

Fig. 68

- ▶ Carry out action steps according to the illustration.
- ▷ Entry of the new door code successful.

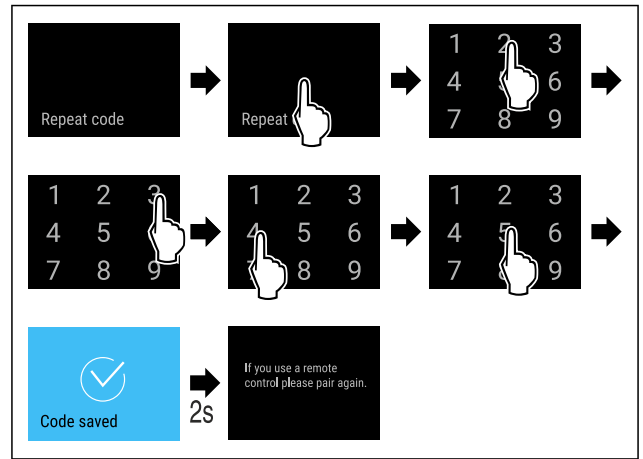

Fig. 69

- ▶ Carry out action steps according to the illustration.
- ▷ Confirmation of the new door code successful.
- ▷ The door code has been changed.

Resetting door code

Door code forgotten or not known.

- ▶ Reset appliance to factory settings. (see 7.2.20 Resetting to factory settings)
- ▷ The appliance is reset to the original settings.
- ▷ The factory setting for the door code is: **1 1 1 1**



Display lock

Changing display lock code

This setting allows the code for the display lock to be changed.

The setting is made in 3 stages:

- Entering of old code
- Entering of new code
- Confirming of new code

Note

- ▶ In the following example, the default factory-set code **1 1 1 1** is changed.
- ▶ The new code is: **2 3 4 5**



Fig. 70

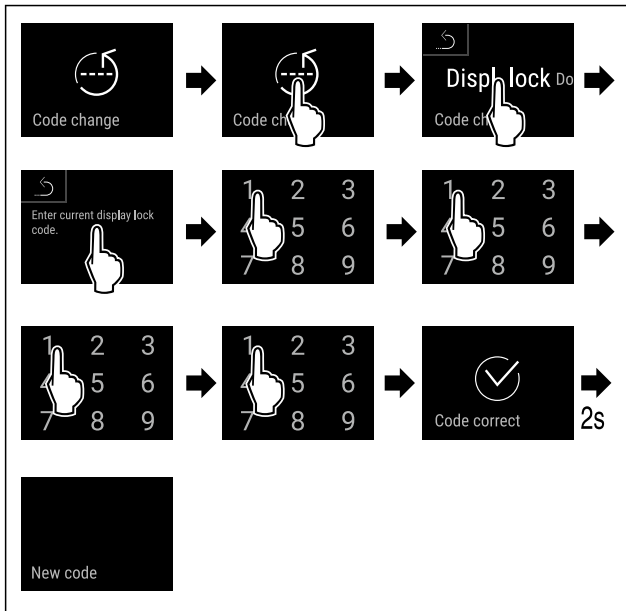

Fig. 71

- ▶ Carry out action steps according to the illustration.
- ▷ Entry of the old code successful.

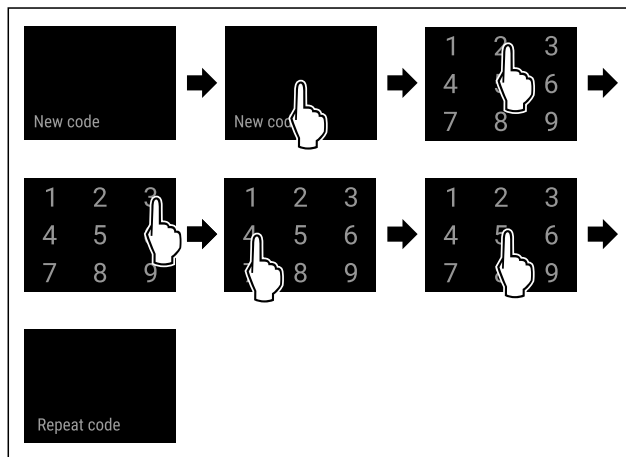

Fig. 72

- ▶ Carry out action steps according to the illustration.
- ▷ Entry of the new code successful.

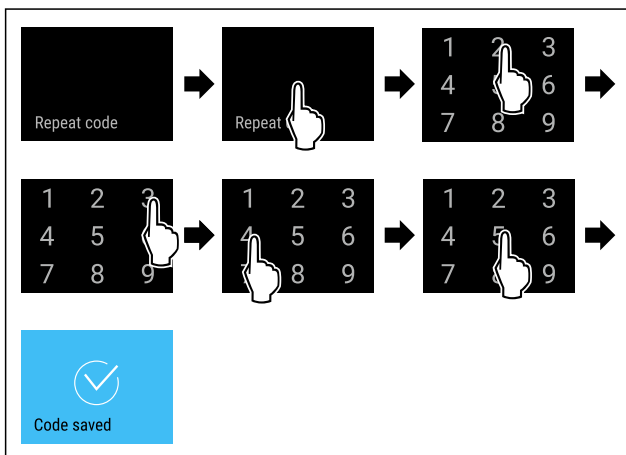

Fig. 73

- ▶ Carry out action steps according to the illustration.
- ▷ Confirmation of the new code successful.
- ▷ The code has been changed.

Resetting display lock code

Code forgotten or not known.

- ▶ Reset appliance to factory settings. (see 7.2.20 Resetting to factory settings)
- ▷ The appliance is reset to the original settings.
- ▷ The factory-set code is: **1 1 1 1**

7.2.15 Language



This setting allows the display language to be set.

Setting language

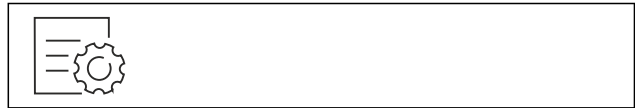

Fig. 74

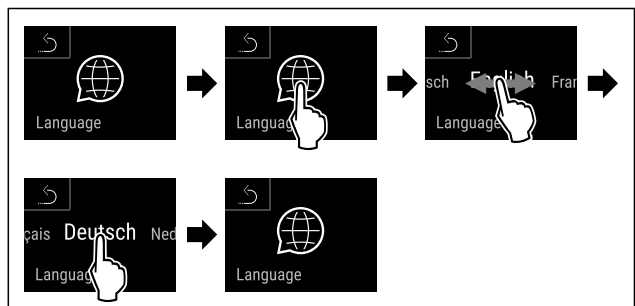

Fig. 75

- ▶ Carry out action steps according to the illustration.
- ▷ The selected language is set.

7.2.16 Device information



Use this function to indicate the model name, index, serial number and service number of your device. You will need the device information when you contact customer service. (see 10.4 Customer Service)

This function also opens the Advanced menu. (see 3 Functionality of the Touch & Swipe display)

Indicating the device information



Fig. 76



Fig. 77

- ▶ Carry out action steps according to the illustration.
- ▷ Display indicates device information.

7.2.17 Software



Use this function to indicate the software version of your device.

Controls

Indicating the software version



Fig. 78



Fig. 79

- ▶ Carry out action steps according to the illustration.
- ▷ Display indicates software version.

7.2.18 Reminder



This function allows you to activate or deactivate the reminder to change theFreshAir activated charcoal filter.

Deactivating the reminder



Fig. 80

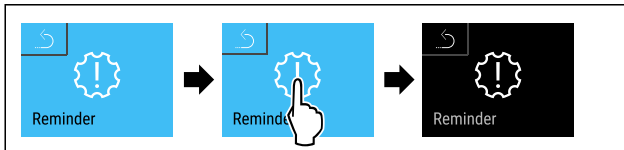

Fig. 81

- ▶ Carry out steps according to the illustration.
- ▷ Reminder is deactivated.

Activating the reminder

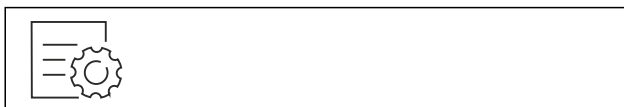

Fig. 82

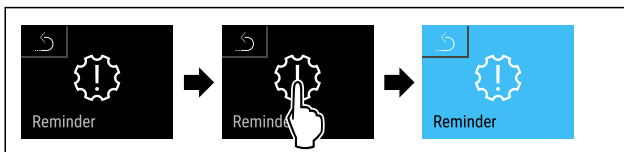
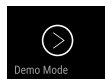

Fig. 83

- ▶ Carry out steps according to the illustration.
- ▷ Reminder is activated.

7.2.19 Demo mode



Demo mode is a special feature for dealers who want to demonstrate appliance features. If you activate demo mode, all refrigeration functions are deactivated.

If you switch on your appliance and a “D” appears on the status display, demo mode is already activated.

If you activate and then deactivate demo mode, the appliance will be reset to factory defaults. (see 7.2.20 Resetting to factory settings)

Activating demo mode



Fig. 84

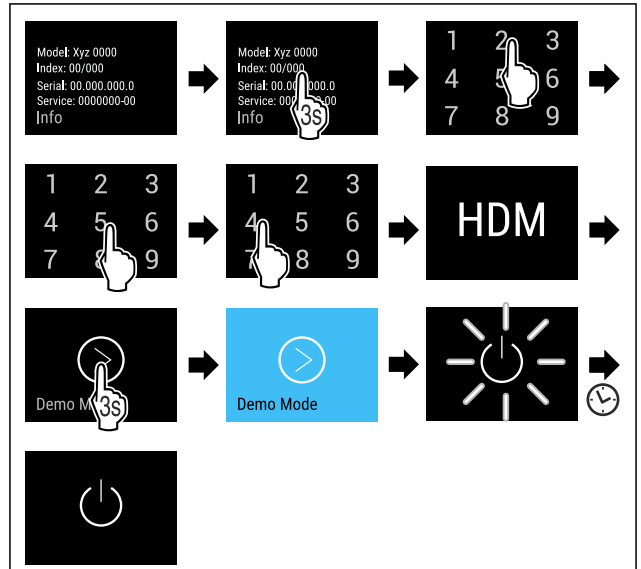

Fig. 85

- ▶ Carry out action steps according to the illustration.
- ▷ Demo mode is activated.
- ▷ Appliance is switched off.
- ▶ Switch on the appliance. (see 4.1 Switching on appliance (first use))
- ▷ “D” appears in the status display.

Deactivating demo mode



Fig. 86

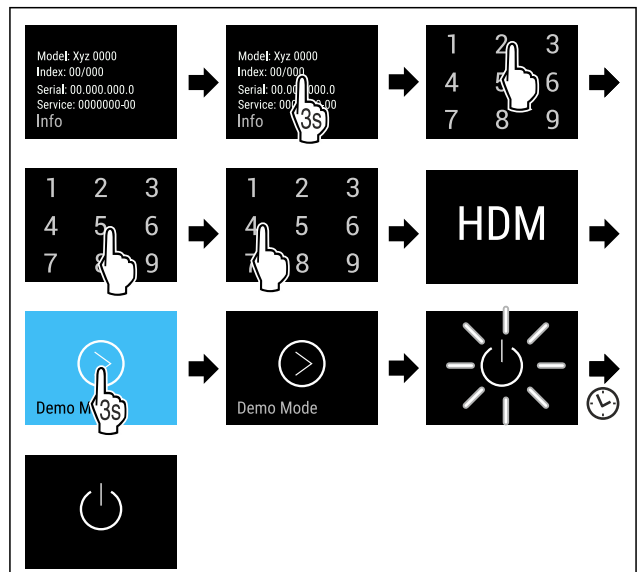

Fig. 87

- ▶ Carry out action steps according to the illustration.
- ▷ Demo mode is deactivated.
- ▷ Appliance is switched off.
- ▶ Switch on the appliance. (see 4.1 Switching on appliance (first use))
- ▷ Appliance is reset to factory settings.

7.2.20 Resetting to factory settings



Use this function to reset all settings to factory defaults. All settings you have made so far are reset to their original settings.

Performing a reset

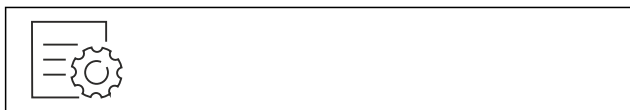

Fig. 88

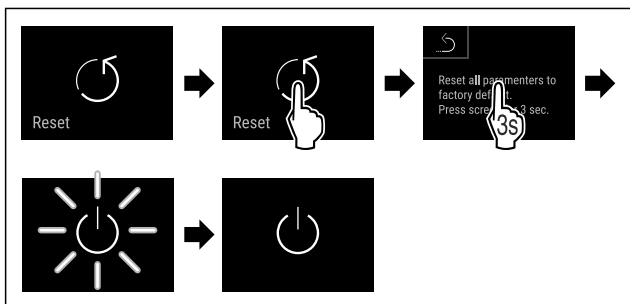

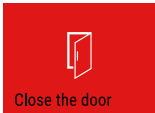

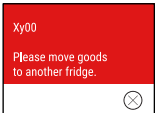

Fig. 89

- ▶ Carry out action steps according to the illustration.
- ▷ Device is reset.
- ▷ Device is switched off.
- ▶ Restart the device. (see 4.1 Switching on appliance (first use))



7.3 Message

7.3.1 Warnings

Warnings are issued by means of an acoustic signal and visually via a symbol on the display. The signal gets louder until the warning is acknowledged.

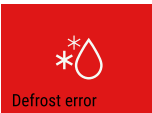

Message (red)	Cause	Remedy
 <p>Door open</p>	<p>This message appears if the door is open for too long.</p>	<p>Close the door. Tap briefly. Alarm is stopped.</p> <p>Note The time until the message appears can be set. (see 7.2.10 Door alarm)</p>
 <p>Temperature alarm</p>	<p>This message appears if the temperature does not match the set temperature. Reasons for differences in temperature can be:</p> <p>Warm produce for cooling has been placed inside.</p> <p>Too much warm air has got in while you were sorting out the freezer or removing items.</p> <p>The power was cut off for a prolonged period.</p>	<p>Tap briefly. Information about errors and appliance status are displayed. Tap briefly. Warmest/coldest temperature, date and time are displayed. Tap briefly. The status screen is displayed. The current temperature and the alarm symbol flash red until the set temperature is reached. Check the quality of the refrigerated goods.</p>
 <p>Error</p>	<p>The appliance is faulty, there is an appliance error or a component of the appliance has a fault.</p>	<p>Store the cooled produce elsewhere.</p> <p>Tap briefly. The error code (e.g. BT021) is displayed.</p> <p>Tap briefly. A further error code is displayed if there is one</p> <p>or Status screen is displayed with flashing error symbol.</p> <p>Swiping or tapping the display will show the error code(s) again. Make a note of error code(s) and contact Customer Service. (see 10.4 Customer Service)</p>  

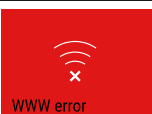
Features

Message (red)	Cause	Remedy
 <p>Power failure</p> <p>Power cut</p>	The message appears following an interruption to the electricity supply.	Tap briefly. Battery's state of charge, information about errors and appliance status are displayed Tap briefly. Highest temperature, time period and number of electricity supply interruptions are displayed. Tap briefly. The status screen is displayed. The current temperature and the alarm symbol flash red until the set temperature is reached. Check the quality of the refrigerated goods.
 <p>Defrost error</p> <p>Defrost error</p>	The automatic defrosting is not working properly. The previous five defrost cycles were not successful.	Press briefly. Alarm is stopped. Contact Customer Service. (see 10.4 Customer Service)
 <p>WiFi error</p> <p>WiFi error</p>	Wi-Fi connection is interrupted.	Check connection. Press briefly. Alarm is stopped.
 <p>WWW error</p> <p>WWW error, WiFi</p>	This message appears if there is no internet connection via WiFi.	Check connection. Press briefly. Alarm is stopped.

7.3.2 Reminders

Reminders appear when you are being asked to do something. They are issued by means of an acoustic signal and visually via a symbol on the display. Acknowledge the message by pressing the confirmation button.

Message (yellow)	Cause	Remedy
 <p>Manually opened</p> <p>Manually opened</p>	This message appears if a door which has been locked electronically is manually opened.	Close the door. Press briefly. Enter the door code to close it again. Reminder is closed.
 <p>FreshAir filter</p> <p>ReplaceFreshAir activated charcoal filter</p>	The message appears every 6 months.	ReplaceFreshAir activated charcoal filter, Press briefly. Reminder is closed.

8 Features

8.1 Safety lock

The appliance is fitted with an electronic lock.

Possible functions:

- Locking and unlocking the door lock using the door code.

8.1.1 Emergency unlocking

In the event of a power failure, the door can be opened using the emergency unlocking key.

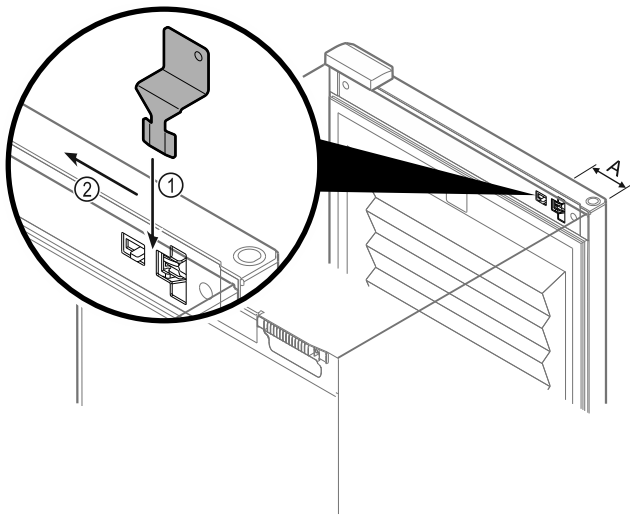

Fig. 90

- ▶ Position the emergency unlocking key in the location shown Fig. 90 (A) ≈ 100mm.
- ▶ Insert the emergency unlocking key from above between the door and the appliance body as far as it will go Fig. 90 (1).
- ▶ Drag the emergency unlocking key towards the hinge side Fig. 90 (2).
- ▷ The lock is unlocked. The door can be opened.

8.2 Labels

Description labels as accessories can be purchased from your specialist dealer. You can use these to note the types of wine that are stored in the respective compartment.

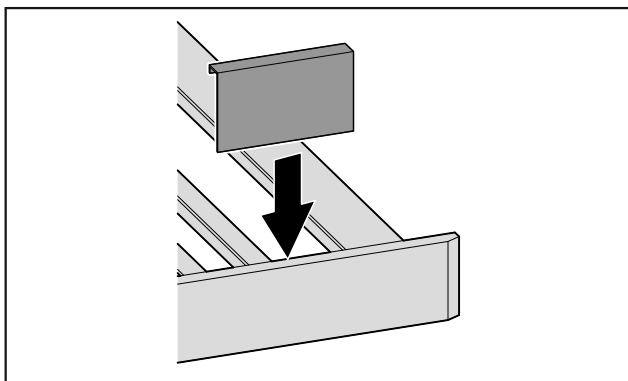

Fig. 91

- ▶ Attach the label from above.

9 Maintenance

9.1 Air exchange through the FreshAir activated charcoal filter

Wine is constantly developing according to its ambient conditions, so air quality is essential for preservation.

The FreshAir activated charcoal filter guarantees optimal air quality.

- Change the activated charcoal filter every 6 months.
- Dispose of the activated charcoal filter with regular household waste.

Note

FreshAir activated charcoal filters can be purchased from the Liebherr-Hausgeräte store at home.liebherr.com/shop/de/deu/zubehor.html.

9.1.1 Replacing the FreshAir activated charcoal filter

Must be carried out multiple times depending on the equipment.

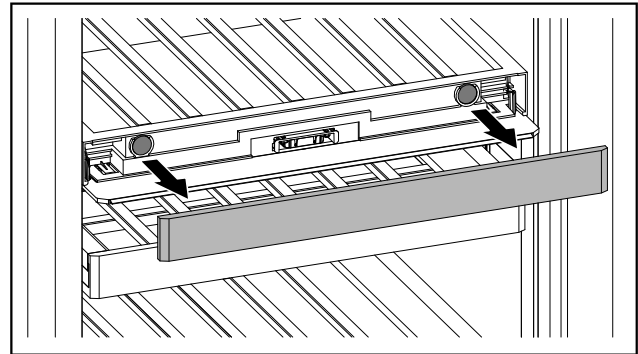

Fig. 92

- ▶ Remove the panel.

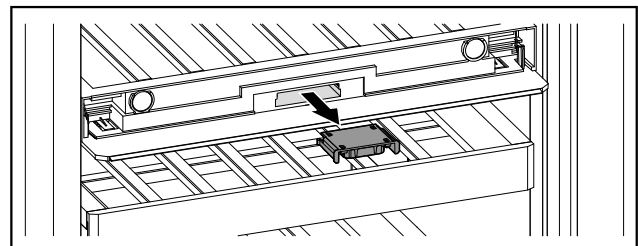

Fig. 93

- ▶ Pull the drawer out.

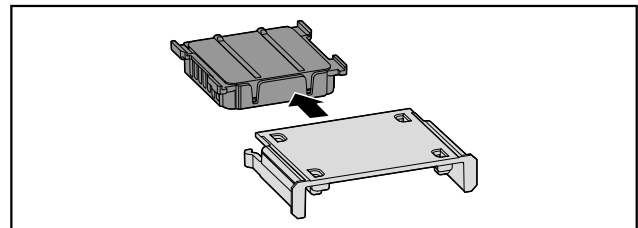

Fig. 94

- ▶ Pull out the filter.

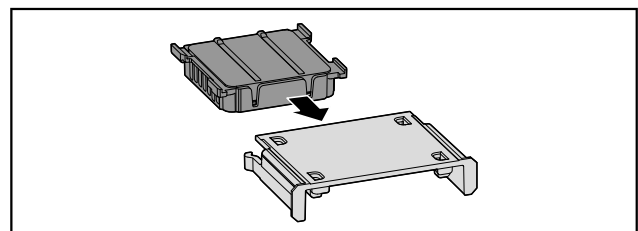

Fig. 95

- ▶ Insert the new filter.

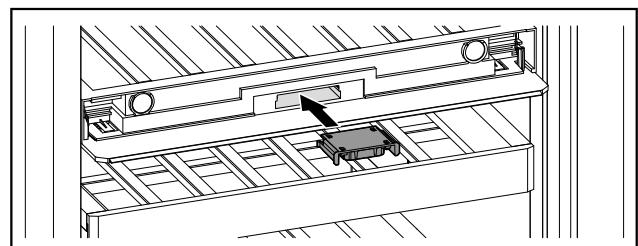

Fig. 96

- ▶ Push the drawer in.

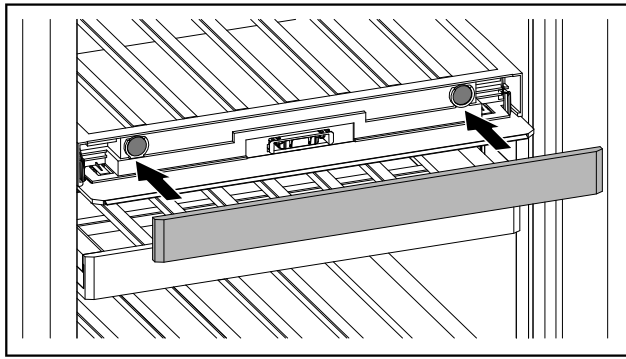

Fig. 97

- ▶ Set the panel back in place.

9.2 Cleaning the appliance

9.2.1 Ready



WARNING

Danger of electric shock!

- ▶ Remove the refrigerator connector or interrupt the power supply.



WARNING

Risk of fire

- ▶ Do not damage the refrigeration circuit.

- ▶ Empty the appliance.
- ▶ Remove mains connector.

9.2.2 Clean the housing

NOTICE

Improper cleaning!

Damage to the appliance.

- ▶ Only use soft cleaning cloths and ph-neutral all-purpose cleaners.
- ▶ Do not use abrasive sponges or steel wool which may cause scratches.
- ▶ Do not use any sharp or abrasive cleaning agents, nor any that contain sand, chloride or acid.



WARNING

Risk of injury and damage as a result of hot steam!

Hot steam can lead to burns and can damage the surfaces.

- ▶ Do not use any steam cleaners!
- ▶ Wipe the housing down with soft, clean cloth. If very dirty, use lukewarm water with a neutral cleaner. Glass surfaces can also be cleaned with glass cleaner.

9.2.3 Cleaning the interior

NOTICE

Improper cleaning!

Damage to the appliance.

- ▶ Only use soft cleaning cloths and ph-neutral all-purpose cleaners.
- ▶ Do not use abrasive sponges or steel wool which may cause scratches.
- ▶ Do not use any sharp or abrasive cleaning agents, nor any that contain sand, chloride or acid.

- ▶ Plastic surfaces: clean by hand with a soft clean cloth, lukewarm water and a little detergent.

- ▶ Metal surfaces: clean by hand with a soft clean cloth, lukewarm water and a little detergent.

9.2.4 Cleaning the equipment

NOTICE

Improper cleaning!

Damage to the appliance.

- ▶ Only use soft cleaning cloths and ph-neutral all-purpose cleaners.
- ▶ Do not use abrasive sponges or steel wool which may cause scratches.
- ▶ Do not use any sharp or abrasive cleaning agents, nor any that contain sand, chloride or acid.

Cleaning with a damp, lint-free cloth:

- Bottle shelf
- ▶ Clean the equipment.

9.2.5 After cleaning

- ▶ Wipe the appliance and the components dry.
- ▶ Connect and switch on the appliance.
- ▶ Repeat cleaning regularly.

10 Customer help

10.1 Technical specifications

Maximum load weight of equipment		
Equipment	Appliance width 600 mm (see installation instructions, appliance dimensions)	Appliance width 750 mm (see installation instructions, appliance dimensions)
Bottle shelf	60 kg	60 kg

Lighting	
Class ¹	Light source
This product contains one or more energy efficiency class G light sources.	LED

¹ The appliance may contain light sources with different energy efficiency classes. The lowest energy efficiency class is indicated.

For appliances with a WiFi connection:

Frequency specification	
Frequency band	2.4 GHz
Maximum radiated power	< 100 mW
Purpose of the wireless equipment	Integration in the local WiFi network for data communication

10.2 Operating noises

The appliance makes different noises when it is on.

- At **higher temperatures** the appliance uses less energy but works for longer. It is **quieter**.
- At **lower temperatures** the food is cooled faster. It is **louder**.

Examples:

- Functions on (see 7.2 Appliance functions)
- Fan running
- Food recently added
- High ambient temperature
- Door open for a while

Noise	Possible cause	Type of noise
Bubbling and splashing	Coolant flowing into the cooling circuit.	Normal operating noise
Hissing	Coolant sprays into the cooling circuit.	Normal operating noise
Humming	The appliance is cooling. The volume depends on the cooling output.	Normal operating noise
Suction noises	Soft-closing door is being opened and closed.	Normal operating noise
Humming and rustling	The fan is running.	Normal operating noise
Clicking	Components are switched on and off.	Normal switching noise

Noise	Possible cause	Type of noise
Rattling or humming	Valves or flaps are working.	Normal switching noise

Noise	Possible cause	Type of noise	Lifting
Vibration	Improper setup	Defective noise	Level the appliance using the adjustable feet.
Rattling	Components, items inside the appliance	Defective noise	Secure components. Leave enough space between the items.

10.3 Technical fault

Your appliance is designed and built to ensure it works reliably and has a long service life. In the unlikely event that a fault occurs during operation, please check whether it is due to an operating error. If so, you will be charged for the callout and repair costs even if it falls within the warranty period.

You can fix the following faults yourself.

10.3.1 Appliance function

Defect	Cause	Remedy
The appliance is not working.	→ The appliance is not switched on.	▶ Switch the appliance on.
	→ The power plug is not properly plugged into the socket.	▶ Check the power plug.
	→ There is something wrong with the power outlet fuse.	▶ Check the fuse.
	→ Power cut	▶ Keep the appliance closed.
	→ The IEC socket is not plugged into the appliance correctly.	▶ Check the IEC socket.
Temperature is not cold enough.	→ The appliance door is not closed properly.	▶ Close the appliance door.
	→ Not enough ventilation.	▶ Keep ventilation grille clear, and clean it.
	→ The ambient temperature is too high.	▶ Problem solution: (see 1.4 Appliance range of use)
	→ The appliance was opened too many times or for too long.	▶ Wait to see if the required temperature corrects itself. If not, contact Customer Service. (see 10.4 Customer Service)
	→ The temperature is set incorrectly.	▶ Turn down the temperature and check after 24 hours.
	→ The appliance is too close to a heat source (oven, radiator, etc).	▶ Move the appliance or the heat source.

Shutting down

Defect	Cause	Remedy
The door seal is defective or needs to be replaced for another reason.	→ The door seal can be replaced. It can be replaced without the need for special tools.	▶ Contact Customer Service. (see 10.4 Customer Service)
The appliance builds up too much ice or condensation.	→ The door seal may have slipped out of its groove.	▶ Check that the door seal is well fitted in the groove.
The appliance is hot to touch on the outside*.	→ The heat of the refrigeration circuit is used to avoid condensation.	▶ This is normal.

10.3.2 Features

Defect	Cause	Remedy
Mould on the wine bottles	→ Similar to other types of bearing, a slight layer of mould can form depending on the type of adhesive used for the label.	▶ Remove any adhesive residues.
The internal light does not come on.	→ The appliance is not switched on.	▶ Switch the appliance on.
	→ The door was open for longer than 15 minutes.	▶ Interior lighting switches off automatically after about 15 minutes when the door is open.
	→ The LED interior light is faulty or the lid is damaged.	▶ Contact Customer Service. (see 10.4 Customer Service)

10.4 Customer Service

First check whether you can rectify the fault yourself (see 10 Customer help) . If you cannot rectify the problem, contact Customer Service.

You can find the address in the enclosed brochure “Liebherr-Service” or at home.liebherr.com/service.



WARNING

Unprofessional repair!
Injuries.

- ▶ Have any repairs and action - not expressly specified - on the appliance and mains cable carried out by service personnel only. (see 9 Maintenance)
- ▶ A damaged mains cable may only be replaced by the manufacturer, the manufacturer’s Customer Service or a similarly qualified person.
- ▶ In the case of appliances with an IEC connector, the change may be made by the customer.

10.4.1 Contacting Customer Service

Make sure that the following appliance information is available:

- Appliance name (model and index)
- Service no. (Service)
- Serial no. (S no.)
- ▶ Call up the appliance information via the display.
- or-
- ▶ Refer to the type plate for appliance information. (see 10.5 Model plate)
- ▶ Note down the appliance information.

- ▶ Notify customer service: Report errors and the appliance information.
- ▷ This will help us to provide you with a faster, more accurate service.
- ▶ Follow further instructions from Customer Service.

10.5 Model plate

The type plate is located on the bottom left of the inside of the appliance.

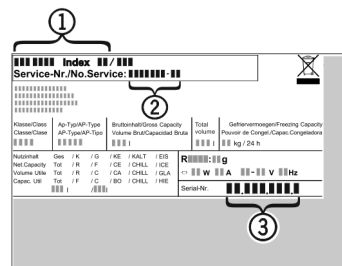

Fig. 98

- (1) Appliance description (3) Serial no.
- (2) Service no.
- ▶ Note the data on the model plate.

11 Shutting down

- ▶ Empty the appliance.
- ▶ Switch off appliance. (see 7.2.2 Switching appliance on and off)
- ▶ Pull the mains plug out of the socket.
- ▶ Remove the IEC socket if required: Pull the IEC socket out of the appliance plug and move it to the left and right at the same time.

- ▶ Clean appliance. (see 9.2 Cleaning the appliance)
- ▶ Leave the door open, so that no unpleasant odours arise.

12 Disposal

12.1 Preparing appliance for disposal



Li-Ion

Liebherr uses batteries in some of its appliances. In the EU, for environmental reasons, legislation obliges the end user to remove these batteries before disposing of old appliances. If your appliance contains batteries, a corresponding notice is attached.

Lamps If you can remove the lamps yourself without destroying them, also remove these before disposal.

- ▶ Take the appliance out of operation.
- ▶ If possible: remove lamps without destroying them.

12.2 Disposing of the appliance in an environmentally friendly manner



The appliance still contains valuable materials and must be disposed of separately from unsorted municipal waste.



Li-Ion



Li-Ion

Dispose of batteries separately from the old appliance. To do this, you can return the batteries free of charge to retailers as well as recycling centres and collection centres for recyclable materials.

Lamps Dispose of removed lamps via the respective collection systems.

For Germany: You can dispose of the appliance free of charge via the class 1 collection containers at the local recycling and recyclable material collection centres. When purchasing a new fridge/freezer, if the sales area > 400 m², retailers will also take back the old appliance free of charge.



WARNING

Leaking coolant and oil!

Fire. The coolant contained in the appliance is eco-friendly, but also flammable. The oil contained in the appliance is flammable. Escaping coolant and oil can ignite if the concentration is high enough and in contact with an external heat source.

- ▶ Do not damage the pipelines of the coolant circuit and the compressor.
- ▶ Observe the notes on transporting the appliance.
- ▶ Transport the appliance without damaging it.
- ▶ Dispose of batteries, lamps and the appliance according to the above specifications.



home.liebherr.com/fridge-manuals

EN wine cooling cabinet

Issue date: 20240913

Part number index: 7083544-00

Liebherr-Hausgeräte Marica EOOD
Bezirk Plovdiv
4202 Radinovo
Bulgarien