



User Guide

Quality, Design and Innovation



















home.liebherr.com/fridge-manuals







LIEBHERR

Contents

1	Appliance at a glance.....	3
1.1	Scope of delivery.....	3
1.2	Overview of appliances and equipment.....	3
1.3	SmartDevice.....	3
1.4	Appliance range of use.....	3
1.5	Conformity.....	4
1.6	SVHC substances according to REACH regulation.....	4
1.7	EPREL database.....	4
2	General safety instructions.....	4
3	Functionality of the Touch display.....	5
3.1	Navigation and symbol explanation.....	5
3.2	Menus.....	6
3.3	Sleep mode.....	6
4	Putting into operation.....	7
4.1	Switching on appliance (first use).....	7
5	Storage.....	7
5.1	Information regarding storage.....	7
5.2	Freezer compartment.....	7
5.3	Storage times.....	8
6	Saving energy.....	8
7	Controls.....	8
7.1	Controls and displays.....	8
7.1.1	Status display.....	8
7.1.2	Display symbols.....	8
7.2	Appliance functions.....	9
7.2.1	Notes on the appliance functions.....	9
	Switching the appliance off and on.....	9
	WiFi.....	9
	Temperature.....	10
	Temperature unit.....	10
	SuperFrost.....	11
	Start defrosting cycle*.....	11
	PartyMode.....	11
	SabbathMode.....	12
	E-Saver.....	12
	Display brightness.....	13
	Door alarm.....	13
	Input lock.....	13
	Device information.....	14
	Software.....	14
	Demo mode.....	14
	Resetting to factory settings.....	15
7.3	Messages.....	15

7.3.1	Overview of warnings.....	15
7.3.2	Ending warnings.....	15
7.3.3	Overview of reminders.....	16
8	Features.....	16
8.1	Drawers.....	16
8.2	Glass shelves.....	17
8.3	VarioSpace.....	18
9	Maintenance.....	18
9.1	Disassembling / assembling pull-out systems.....	18
9.2	Defrosting the appliance.....	19
9.3	Cleaning the appliance.....	19
10	Customer help.....	20
10.1	Technical specifications.....	20
10.2	Operating noises.....	20
10.3	Technical fault.....	21
10.4	Customer Service.....	22
10.5	Model plate.....	22
11	Shutting down.....	22
12	Disposal.....	22
12.1	Preparing appliance for disposal.....	22
12.2	Disposing of the appliance in an environmentally friendly manner.....	22

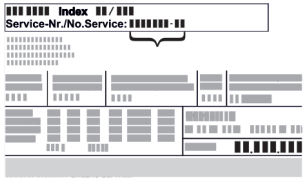
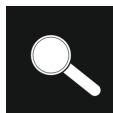
The manufacturer is continually working on the further development of all types and models. Please be aware that we reserve the right to make changes to the shape, equipment and technology.

Symbol	Explanation
	<p>Read instructions</p> <p>Please read the information in these instructions carefully to understand all of the benefits of your new appliance.</p>
	<p>Additional information on the Internet</p> <p>The digital manual with additional information and in other languages can be found via the QR code on the front of the manual or by entering the service number at home.liebherr.com/fridge-manuals.</p> <p>The service number can be found on the serial tag:</p> <div style="text-align: center;">  <p><i>Fig. Example illustration</i></p> </div>
	<p>Check appliance</p> <p>Check all parts for transport damage. If you have any complaints, please contact your agent or customer service.</p>
	<p>Differences</p> <p>These instructions apply to a range of models, so differences are possible. Sections that apply to certain models only are marked with an asterisk (*).</p>
	<p>Instructions and results</p> <p>Instructions are marked with a ▶.</p> <p>Results are marked with a ▷.</p>

Symbol	Explanation
	Videos Videos about the appliances are available on the YouTube channels of Liebherr-Hausgeräte.

These operating instructions apply to:

IF(N)(S)..	35.. / 39..
SIFN(S)..	51..

Note

If your appliance has an N in its appliance designation, it is a NoFrost appliance.*

1 Appliance at a glance

1.1 Scope of delivery

Check all parts for transport damage. Contact your dealer or customer service in the event of complaints. (see 10.4 Customer Service)

Your new appliance comes with the following parts:

- Built-in appliance
- Features (depending on the model)
- Installation materials (depending on the model)
- "Quick Start Guide"
- "Installation Guide"
- Service Brochure

1.2 Overview of appliances and equipment

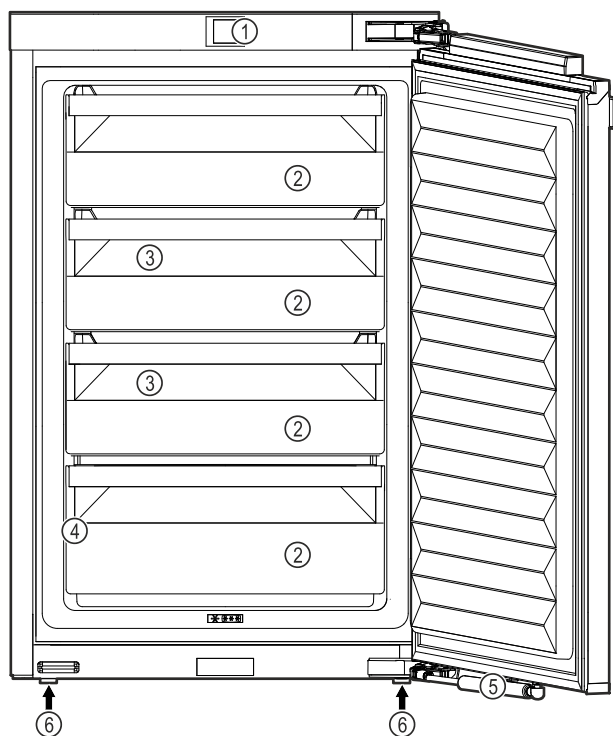

Fig. 1 Example illustration

- | | |
|----------------|-----------------------------|
| (1) Controls | (4) Type plate |
| (2) Drawers | (5) Soft-closing mechanism* |
| (3) VarioSpace | (6) Adjusting feet |

Note

- ▶ Shelves, drawers and baskets are arranged for optimum energy efficiency when the appliance is delivered. Changing how the shelves, for example, are inserted in the fridge compartment does not have any impact on energy consumption.

1.3 SmartDevice

SmartDevice is the networking solution for your freezer.

If your appliance SmartDevice-enabled or compatible, you can quickly and easily connect your appliance to your WiFi. With the SmartDevice app, you can operate your appliance from a mobile device. Additional functions and setting options are available in the SmartDevice SmartDevice app.

SmartDevice-compatible appliance: Your appliance is compatible for use with the SmartDeviceBox. You must first purchase and install the SmartDeviceBox. In order to connect your appliance to the WiFi, you need to download the SmartDevice app.



More information about SmartDevice: smartdevice.liebherr.com

Purchasing the SmartDeviceBox in the Liebherr-Hausgeräte store: home.liebherr.com/shop/de/deu/smartdevicebox.html

Downloading the SmartDevice app:



After installing and configuring the SmartDevice, you can connect your appliance to the WiFi using the SmartDevice app and the WiFi appliance function (see WiFi).

Note

The SmartDevice function is not available in the following countries: Russia, Belarus, Kazakhstan.

You cannot use the SmartDeviceBox.

1.4 Appliance range of use

Intended use

The appliance is only suitable for cooling food products in a domestic or household-like environment. This includes, for example, use:

- in staff kitchens, bed and breakfast establishments,
- by guests in country houses, hotels, motels and other accommodation,
- for catering and similar services in the wholesale trade.

All other types of use are not permitted.

General safety instructions

Foreseeable misuse

The following applications are expressly forbidden:

- Storing and refrigerating medicines, blood plasma, laboratory preparations or similar substances and products based on the Medical Device Directive 2007/47/EC
- Use in areas at risk of explosions

Misusing the appliance may lead to damage to the goods stored or they may spoil.

Climate classifications

Depending on the climate classification the appliance is designed to operate in restricted ambient temperatures. The climate classification applying to your appliance is printed on the rating plate.

Note

► Keep to the specified ambient temperatures in order to guarantee that the appliance works properly.

Climate classification	for ambient temperatures of
SN	10 °C to 32 °C
N	16 °C to 32 °C
ST	16 °C to 38 °C
T	16 °C to 43 °C
SN-ST	10 °C to 38 °C
SN-T	10 °C to 43 °C

1.5 Conformity

The refrigerant circuit has been tested for leaks. When installed, the appliance complies with the applicable safety regulations and with the corresponding directives.

The full text of the EU Declaration of Conformity is available on the following website: www.Liebherr.com

1.6 SVHC substances according to REACH regulation

You can check whether your appliance contains SVHC substances according to REACH regulation at the following link: home.liebherr.com/de/deu/de/liebherr-erleben/nachhaltigkeit/umwelt/scip/scip.html

1.7 EPREL database

Details about energy labelling and ecodesign requirements will be available on the European product database (EPREL) from 1st March 2021. You can access the product database at the following link: <https://eprel.ec.europa.eu/> You will be asked to enter the model ID. You can find the model ID on the nameplate.

2 General safety instructions

Please keep these operating instructions in a safe place so you can refer back to them at any time.

If you pass the appliance on, please hand these operating instructions to the next user.

Read these operating instructions carefully before use to ensure safe and correct use of the appliance. Follow the instructions, safety instructions and warning messages included at all times. They are important for ensuring you can operate and install the appliance safely and without any problems.

Danger for the user:

- This device can be used by children and people with impaired physical, sensory or mental abilities or with a lack of experience and knowledge provided that they are supervised or have received instruction in the safe use of this device, and about the resulting hazards.

Children must not play with this appliance. Cleaning and user maintenance work must not be carried out by children without adult supervision. Children aged between 3 and 8 are allowed to load and unload the appliance. Children below the age of 3 must be kept away from the appliance unless they are under continuous adult supervision.

- The socket must be easily accessible so that the appliance can be disconnected quickly from the electricity in an emergency. It must not be located in the area behind the appliance.
- When disconnecting the appliance from the supply, always take hold of the plug. Do not pull the cable.
- In the event of a fault pull out the mains plug or deactivate the fuse.
- Do not damage the mains power cable. Do not operate the appliance with a defective mains power cable.
- Only customer service or other specially trained staff may repair or perform other operations on the appliance.
- Only install, connect and dispose of the appliance according to the instructions.
- Only use the appliance when is installed.

Fire hazard:

- The coolant used (information on the model plate) is ecofriendly but also flammable. Any leaking coolant may ignite.
 - Do not damage the refrigerant circuit pipes.

Functionality of the Touch display

- Do not handle ignition sources inside the appliance.
- Do not use electrical appliances inside the appliance (e.g. steam cleaners, heaters, ice cream makers, etc.).
- If the refrigerant leaks: remove any naked flames or ignition sources from the vicinity of the leakage point. Properly air the room. Inform customer services.
- Do not store explosives or sprays using combustible propellants such as butane, propane, pentane, etc. in the appliance. To identify these spray cans, look for the list of contents printed on the can, or a flame symbol. Gases possibly escaping may ignite due to electrical components.
- Keep burning candles, lamps and other items with naked flames away from the appliance so that they do not set the appliance on fire.
- Please be sure to store alcoholic drinks or other packaging containing alcohol in tightly closed containers. Any alcohol that leaks out may be ignited by electrical components.

Danger of tipping and falling:

- Do not misuse the plinth, drawers, doors etc. as a step or for support. This applies particularly to children.

Danger of food poisoning:

- Do not consume food which has been stored too long.

Danger of frostbite, numbness and pain:

- Avoid prolonged skin contact with cold surfaces or refrigerated/frozen goods or take protective measures, e.g wear gloves.

Danger of injury and damage:

- Hot steam can lead to injury. Do not use electrical heating or steam cleaning equipment, open flames or defrosting sprays to defrost.
- Do not use sharp implements to remove the ice.

Risk of crushing:

- Do not hold the hinge when opening and closing the door. Fingers may get caught.

Symbols on the appliance:



This symbol may be located on the compressor. It relates to the oil in the compressor and makes reference to the risk that: Swallowing or inhaling can be fatal. This advice is only relevant to recycling. There is no danger in normal operation.



This symbol is located on the compressor and indicates the danger of flammable materials. Do not remove the sticker.



This or a similar sticker may be located on the rear of the appliance. This sticker indicates that there are vacuum insulation panels (VIP) or perlite panels in the door and/or housing. This advice is only relevant to recycling. Do not remove the sticker.

Please note the warning messages and other specific advice in the other chapters:

	DANGER	indicates an immediately hazardous situation which will lead to death or serious injuries if it is not avoided.
	WARNING	indicates a hazardous situation which may lead to death or serious injuries if it is not avoided.
	CAUTION	indicates a hazardous situation which may lead to minor or moderate injuries if it is not avoided.
	NOTICE	indicates a hazardous situation which may lead to damage to property if it is not avoided.
	Note	indicates useful instructions and tips.

3 Functionality of the Touch display





You operate your appliance using the Touch display. You select appliance functions in the Touch display (hereafter referred to as display) by tapping them. If you do not perform any action on the display for 10 seconds, the display either jumps back to the higher-level menu or directly to the status display.

3.1 Navigation and symbol explanation

In the illustrations, different symbols are used to navigate the display. The following table describes these symbols.

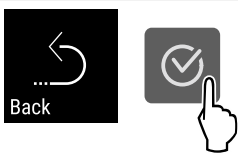
Symbol	Description
	Press the Next navigation arrow: Navigates to the next option in the menu.
	Press the Back navigation arrow: Jumps back one option in the menu.
	Press the navigation arrow several times in succession: Navigates in the menu to the desired function.

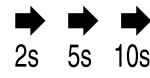
Functionality of the Touch display

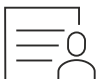
Symbol	Description
	Press the Confirm symbol: Activates/deactivates function. Opens submenu.
	Press the Confirm symbol together with the back icon: Jumps back one menu level.
	Arrow with clock: It takes more than 10 seconds for the following message to appear in the display.
	Arrow with a time indication: It takes the specified amount of time until the following message appears in the display.
	“Open Settings menu” symbol: Navigates to the Settings menu and opens the settings menu. If necessary: Navigate to the desired function in the Settings menu. (see 3.2.1 Opening the Settings menu)
	“Open Advanced menu” symbol: Navigates to the Advanced menu and opens the advanced menu. If necessary: Navigate to the desired function in the Advanced menu. (see 3.2.2 Opening the Advanced menu)
No action for 10 seconds	If you do not perform any action on the display for 10 seconds, the display either jumps back to the higher-level menu or directly to the status display.
Opening door and closing it again	If you open the door and immediately close it again, the display jumps directly back to the status display.

Note: Illustrations of the display are shown in the English version.

3.2 Menus

The appliance functions can be found in various menus.

Menu	Description
Main menu	When you switch the appliance on, you are automatically in the main menu. From here you can navigate to the most important appliance functions, to the Settings menu and to the Advanced menu.

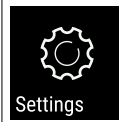
Menu	Description
 Settings menu	The Settings menu contains additional appliance functions for setting up your appliance. (see 3.2.1 Opening the Settings menu)
Advanced menu	The advanced menu contains special appliance functions for setting up your appliance. Access to the Advanced menu is protected by the numerical code 151 . (see 3.2.2 Opening the Advanced menu)

3.2.1 Opening the Settings menu

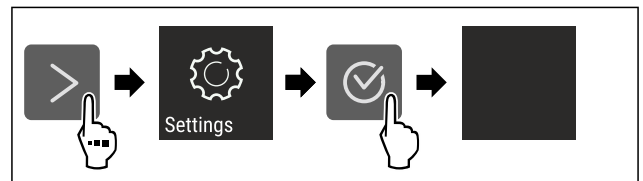

Fig. 2 Example illustration

- ▶ Carry out action steps according to the illustration.
- ▷ Settings menu is open.
- ▶ If necessary: Navigate to the desired function.

3.2.2 Opening the Advanced menu



Fig. 3

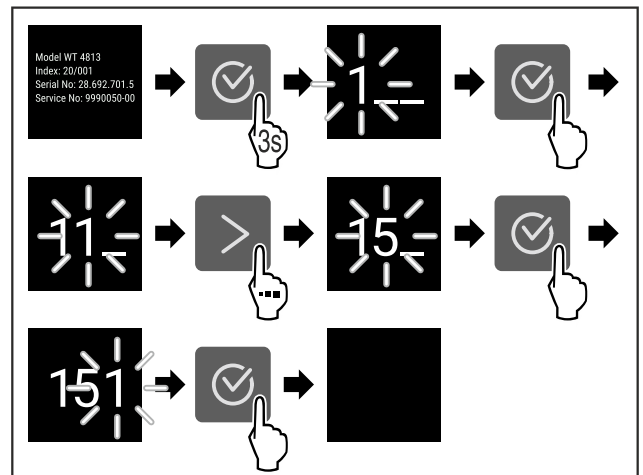

Fig. 4 Example illustration, access with numerical code **151**

- ▶ Carry out action steps according to the illustration.
- ▷ The expanded menu is open.
- ▶ If necessary: Navigate to the desired function.

3.3 Sleep mode

If you do not touch the display for 1 minute, the display switches to sleep mode. In sleep mode, the display brightness is dimmed.

3.3.1 Ending sleep mode

- ▶ Press any navigation key.
- ▷ Sleep mode is ended.

4 Putting into operation

4.1 Switching on appliance (first use)

Make sure that the following requirements are fulfilled:

- The appliance is properly installed and connected according to the installation instructions.
- All adhesive strips, adhesive and protective films and transport locks are removed from inside and on the appliance.
- All marketing leaflets are removed from the drawers.
- You are familiar with the functionality of the Touch display. (see 3 Functionality of the Touch display)

Switch on the appliance using the Touch display:

- ▶ If the display is in sleep mode: Briefly touch the display.
- ▶ Carry out action steps according to the illustration.

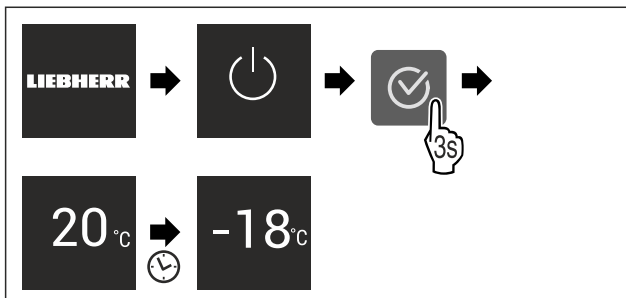

Fig. 5 Example illustration

- ▷ The status display appears.
- ▷ The appliance cools to the temperature set at the factory.
- ▷ The appliance starts in demo mode (status display with DEMO appears): If the appliance starts in demo mode, you can deactivate demo mode within the next 5 minutes. (see Demo mode)

More information:

- Start the SmartDevice for the first time. (see 1.3 Smart-Device) and (see WiFi)

Note

The manufacturer recommends:

- ▶ **Store frozen foods** at -18 °C or colder.
- ▶ Observe the notes on storing food. (see 5.1 Information regarding storage)

Note

Accessories can be purchased from the Liebherr-Hausgeräte store at home.liebherr.com/shop/de/deu/zubehor.html.

5 Storage

5.1 Information regarding storage



WARNING

Risk of fire

- ▶ Do not use any electrical appliances in the food area of the appliance unless recommended by the manufacturer.

Note

The energy consumption increases and the cooling power goes down if ventilation is not sufficient.

- ▶ Always keep air slots clear.

Observe the following specifications for storage:

- Package food properly.

- Package raw meat or fish in clean, closed containers. This will prevent meat or fish from touching or dripping onto other food.
- Leave space between goods to ensure good air circulation.
- Store food according to the instructions on the packaging.
- Always observe the best-before date indicated on the packaging.

Note

Failure to follow these guidelines can lead to foodstuffs spoiling.

5.2 Freezer compartment

Here, a dry, frosty storage climate is created at -18 °C. The frosty storage climate is suitable for storing frozen food for several months, for making ice cubes or freezing fresh food.

5.2.1 Freezing food

Freezing quantity

The maximum amount of fresh food that you can freeze within 24 hours is specified on the type plate (see 10.5 Model plate) under "Freezing capacity ... kg/24h".

To ensure that food quickly freezes through, adhere to the following quantities per package:

- Fruit and vegetables up to 1 kg
- Meat up to 2.5 kg

Freezing food using SuperFrost

Depending on the quantity to be frozen, you can activate SuperFrost before freezing in order to achieve lower freezing temperatures. (see SuperFrost)

Appliance without NoFrost:*

- ▶ Activate SuperFrost if the amount of food you have to freeze is more than approx. 1 kg.*

Appliance with NoFrost:*

- ▶ Activate SuperFrost if the amount of food you have to freeze is more than approx. 2 kg.*

The time at which you activate SuperFrost depends on the amount of food you have to freeze:

Freezing quantity	Time at which you should activate SuperFrost
Small amount of food to freeze	Activate SuperFrost about 6 hours before freezing. You can place the food in the freezer as soon as the appliance automatically deactivates SuperFrost.
Maximum amount of food to freeze	Activate SuperFrost about 24 hours before freezing. You can place the food in the freezer as soon as the appliance automatically deactivates SuperFrost.

Arranging your food properly



CAUTION

Risk of injury from broken glass!

Bottles and cans with beverages can burst during freezing. This applies in particular to carbonated beverages.

- ▶ Only freeze bottles and cans with beverages if you have activated the BottleTimer function in the SmartDevice app.

Saving energy

Appliance height < 1220 mm	
Freezing quantity	Arranging your food properly
Small amount of food to freeze	Distribute packaged groceries throughout all drawers. If possible, place groceries at the back of the drawer near the rear wall.
Maximum amount of food to freeze	Distribute packaged groceries throughout all drawers. If possible, place groceries at the back of the drawer near the rear wall.

Appliance height ≥ 1220 mm	
Freezing quantity	Arranging your food properly
Small amount of food to freeze	Distribute packaged groceries throughout all drawers, but do not place any groceries in the top drawer.
Maximum amount of food to freeze	Distribute packaged groceries throughout all drawers. If possible, place groceries at the back of the drawer near the rear wall.

5.2.2 Defrosting food



WARNING

Risk of food poisoning!

- ▶ Do not re-freeze thawed food.
- ▶ Use defrosted foodstuff as soon as possible.

You can defrost food in several ways:

- In a fridge
- In the microwave
- In the oven/fan-assisted oven
- At room temperature
- ▶ Take out only as much food as necessary.

5.2.3 Freezer tray*

You can freeze berries, herbs, vegetables and other small frozen food in the freezer tray without it all freezing together. The frozen food is less likely to get squashed and subsequent portioning is easier.

- ▶ Distribute food on the freezer tray without packaging and well spaced out.

5.3 Storage times

Refer to the specified storage times as a guide.

In the case of foods with a minimum shelf life, the date indicated on the packaging still applies.

Recommended storage period for various types of food		
Ice cream	at -18 °C	2 to 6 months
Sausages, ham	at -18 °C	2 to 3 months
Bread, baked goods	at -18 °C	2 to 6 months
Game, pork	at -18 °C	6 to 9 months
Fatty fish	at -18 °C	2 to 6 months
Lean fish	at -18 °C	6 to 8 months
Cheese	at -18 °C	2 to 6 months

Recommended storage period for various types of food		
Poultry, beef	at -18 °C	6 to 12 months
Vegetables, fruit	at -18 °C	6 to 12 months

6 Saving energy

- Pay attention to good ventilation. Do not cover ventilation holes or grids.
- Always keep the fan air slits clear.*
- Do not install the appliance in direct sunlight or near radiators or similar sources of heat.
- If the appliance is installed directly next to an oven, the energy consumption may increase slightly. This is dependent on the service life and usage intensity of the oven.
- Energy consumption depends on the installation conditions, e.g. the ambient temperature (see 1.4 Appliance range of use) . A warmer ambient temperature can increase the energy consumption.
- Open the appliance for as short a time as possible.
- The lower the temperature is set the higher the energy consumption.
- Keep all food properly packed and covered. This prevents frost from forming.
- Inserting warm food: allow to cool down to room temperature first.
- If there is a thick layer of frost in the appliance: defrost the appliance.*

7 Controls

7.1 Controls and displays

7.1.1 Status display





Fig. 6

(1) Temperature display

The Status display shows the set temperature and is the home display. From there, you can navigate to the options and settings.

7.1.2 Display symbols

Display symbols provide information on the current appliance status:

Symbol	Appliance status
	Standby The appliance or temperature zone is switched off.
	Flashing number Appliance is working. Temperature flashes until the set value is reached.
	Flashing symbol Appliance is working. Setting is made.

Symbol	Appliance status
	Bar grows steadily Function is activated.

7.2 Appliance functions

7.2.1 Notes on the appliance functions

The appliance functions are set at the factory so that your appliance is fully functional.

Before you alter, activate or deactivate the device functions, make sure that the following requirements are met:

- You have read and understood the descriptions of how the display works. (see 3 Functionality of the Touch display)
- You have familiarised yourself with the operating and display elements of your appliance.

Switching the appliance off and on

Use this function to switch the entire appliance off and on.

Switching off the appliance

When you switch the appliance off, then the previously saved settings are saved.

Make sure that the following requirements are fulfilled:

- Handling instructions (see 11 Shutting down) are carried out.



Fig. 7

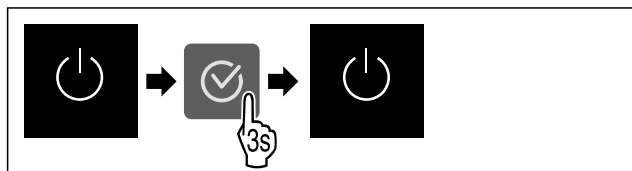

Fig. 8

- ▶ Carry out action steps according to the illustration.
- ▷ Appliance is switched off.
- ▷ The standby symbol appears in the display.
- ▷ Display turns black.

Switching on the appliance

If the display is in sleep mode:

- ▶ Press any navigation key.

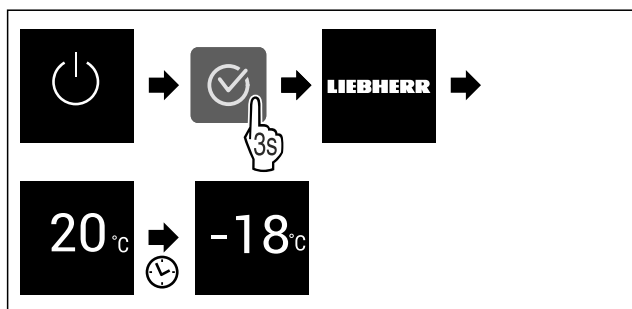

Fig. 9 Example illustration

- ▶ Carry out action steps according to the illustration.
- When the appliance starts in demo mode:
 - ▶ Deactivating demo mode. (see Deactivating demo mode)
 - ▷ The appliance is switched on.

- ▷ Previous settings are restored.
- ▷ The appliance cools to the target temperature set.



WiFi

Use this function to connect your appliance to WiFi. You can then operate it via the SmartDevice app on a mobile device. You can also use this function to disconnect or reset the WiFi connection.

To connect your device to WiFi, you need the SmartDeviceBox.

More information on the SmartDevice: (see 1.3 SmartDevice)

Note

The SmartDevice function is not available in the following countries: Russia, Belarus, Kazakhstan.

You cannot use the SmartDeviceBox.

Establishing the WiFi connection for the first time

Make sure that the following requirements are fulfilled:

- You have purchased and inserted a SmartDeviceBox. (see 1.3 SmartDevice)
- You have installed the SmartDevice app (see apps.home.liebherr.com).
- Registration in the SmartDevice app is completed.



Fig. 10

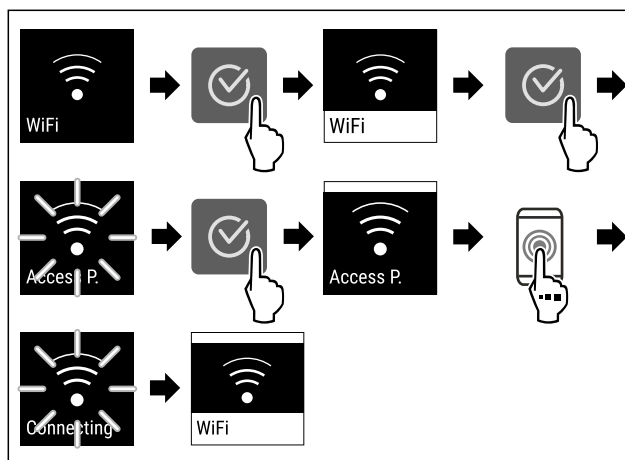

Fig. 11

- ▶ Carry out action steps according to the illustration.
- ▷ Connection is established.

Disconnecting from the WiFi



Fig. 12

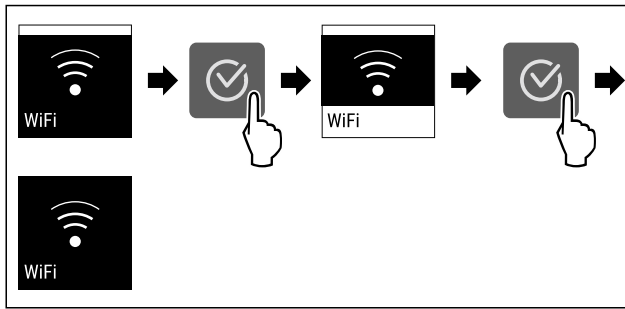

Fig. 13

- ▶ Carry out action steps according to the illustration.
- ▷ There is no connection.

Resetting the WiFi connection



Fig. 14

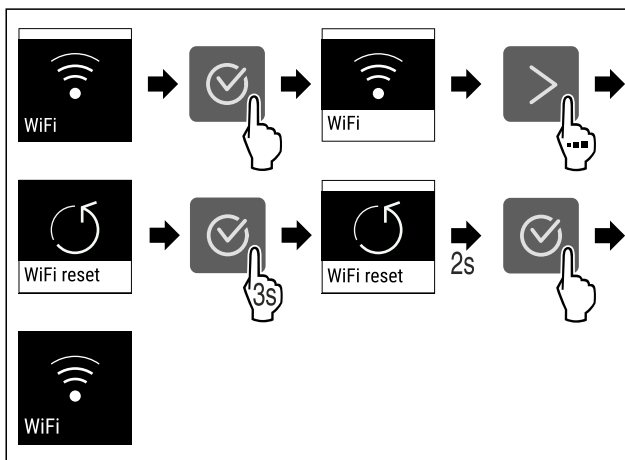

Fig. 15

- ▶ Carry out action steps according to the illustration.
- ▷ WiFi connection and other WiFi settings are reset to factory settings.

Showing information about the WiFi connection



Fig. 16

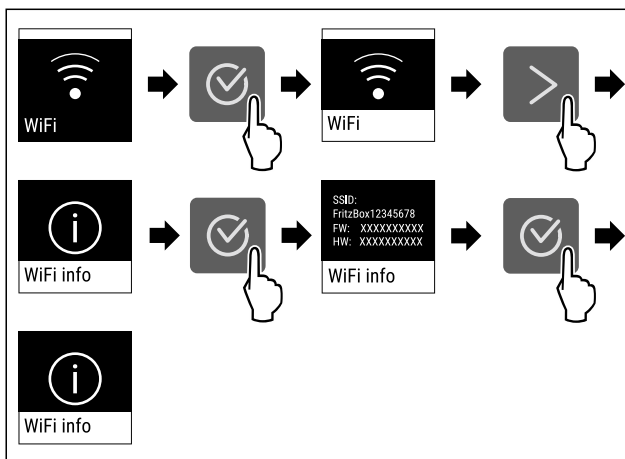

Fig. 17

- ▶ Carry out action steps according to the illustration.

-18°C Temperature

Use this function to set the temperature.

The temperature depends on the following factors:

- Frequency of door opening
- Duration of door opening
- Room temperature of the installation site
- Type, temperature and quantity of food

Freezer compartment	Factory-set temperature	Recommended setting
-18°C	-18 °C	-18 °C

Setting the temperature

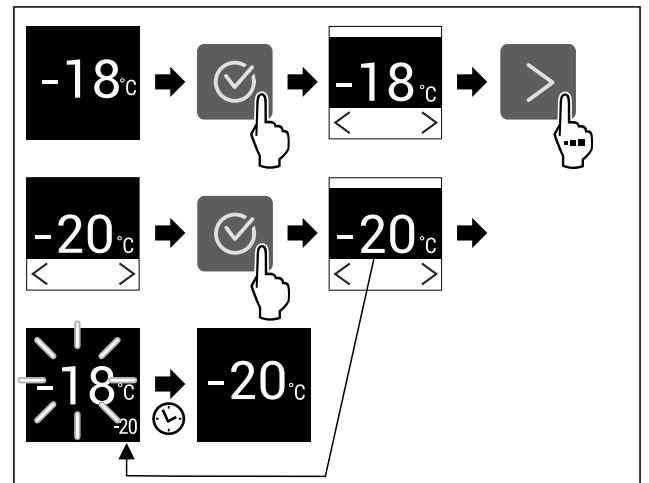

Fig. 18 Example illustration

- ▶ Carry out action steps according to the illustration.
- ▷ Temperature is set.

°C/°F Temperature unit

Use this function to set the temperature unit. You can set degrees Celsius or degrees Fahrenheit as the temperature unit.

Setting the temperature unit

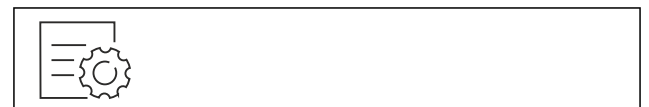

Fig. 19

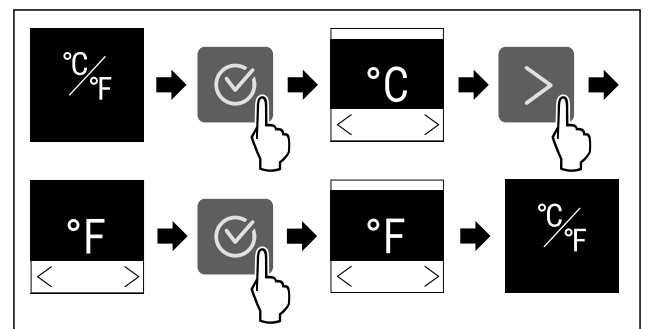

Fig. 20 Example illustration: Switch from degrees Celsius to degrees Fahrenheit.

- ▶ Carry out action steps according to the illustration.
- ▷ The temperature unit is set.

SuperFrost

You can use this function to activate or deactivate SuperFrost. If SuperFrost is activated, then the appliance increases the freezing capacity. It allows you to achieve lower freezing temperatures.

Application:

- Quickly freeze fresh food through to the core. This ensures that the nutrition, appearance and taste of frozen food is maintained.
- Increase the cold reserve in stored frozen food before defrosting the appliance.

If the function is active, the appliance operates at higher power. As a result, the appliance's operating noise may be temporarily louder and energy consumption will increase.

Activating SuperFrost

Make sure that the following requirements are fulfilled:

- Freezing quantity and time for activation of SuperFrost are taken into account. (see Freezing food using SuperFrost)

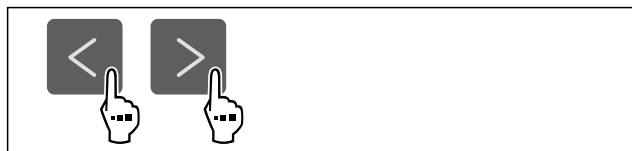

Fig. 21

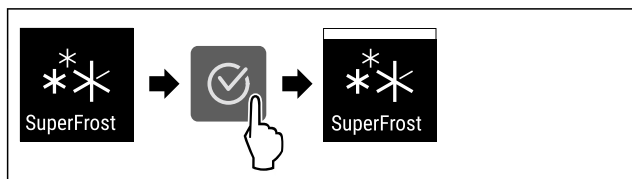

Fig. 22

- ▶ Carry out action steps according to the illustration.
- ▷ SuperFrost is activated.

Deactivating SuperFrost

SuperFrost is automatically deactivated after 56 to 72 hours depending on the quantity of the food inserted. However, you can also deactivate SuperFrost manually at any time:

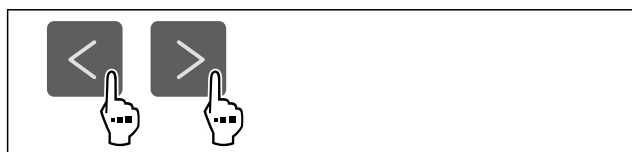

Fig. 23

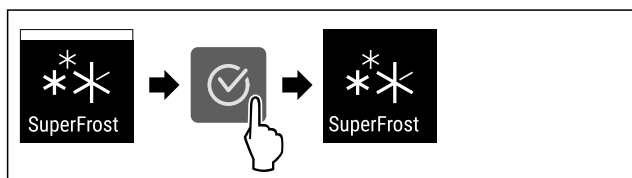

Fig. 24

- ▶ Carry out action steps according to the illustration.
- ▷ SuperFrost is deactivated.
- ▷ The appliance continues to run in normal mode.
- ▷ The appliance cools to the temperature set previously.

Start defrosting cycle*

Use this function to start the automatic defrosting cycle manually if it does not start automatically in the event of a fault.

This function applies to NoFrost devices.*

Starting defrosting cycle



Fig. 25

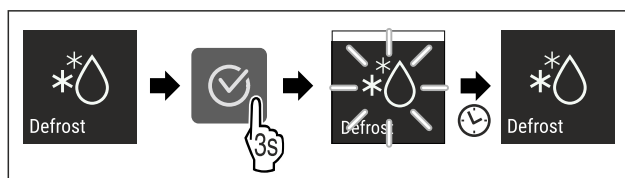

Fig. 26

- ▶ Carry out action steps according to the illustration.
- ▷ Defrosting cycle has started: Icon flashes until defrosting cycle is automatically completed.
- ▷ When defrosting cycle is finished: The device continues to run in normal mode.

Cancelling defrosting cycle

The defrosting cycle will be stopped automatically. However, you can also cancel the defrosting cycle at any time during the defrosting process:

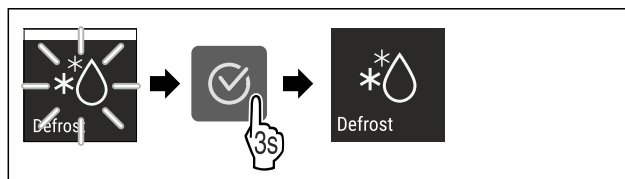

Fig. 27

- ▶ Carry out action steps according to the illustration.
- ▷ Defrosting cycle is cancelled.
- ▷ The device continues to run in normal mode.

PartyMode

You can use this function to activate or deactivate PartyMode. PartyMode activates various functions that are useful for a party.

PartyMode activates the following functions:

- SuperFrost

You can adjust all listed functions individually and flexibly. When you deactivate PartyMode, all changes are discarded.

If the function is active, the device operates at higher power. As a result, the device's operating noise may be temporarily louder and energy consumption will increase.

Activating PartyMode

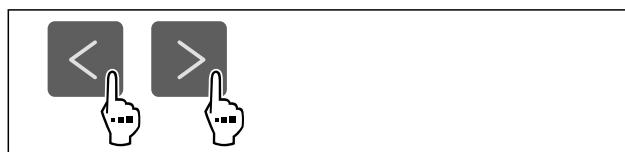

Fig. 28

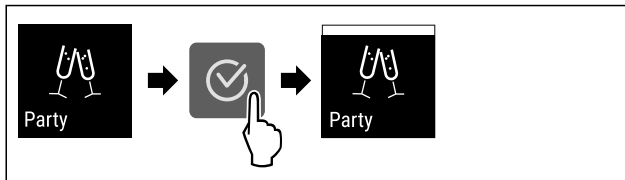

Fig. 29

- ▶ Carry out action steps according to the illustration.
- ▷ PartyMode and the associated functions are activated.
- ▷ The current temperature flashes until the target temperature is reached.

Deactivating PartyMode

The PartyMode is automatically deactivated after 24 seconds. However, you can also deactivate PartyMode manually at any time:

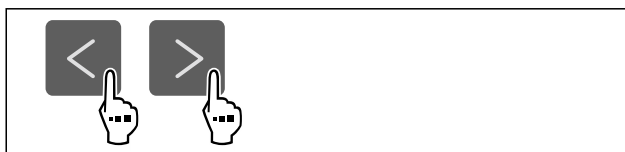

Fig. 30

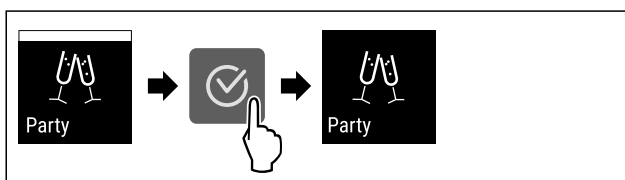

Fig. 31

- ▶ Carry out action steps according to the illustration.
- ▷ PartyMode is deactivated.
- ▷ The appliance cools to the temperature set previously. The current temperature flashes until the target temperature is reached.



SabbathMode

You can use this function to activate or deactivate SabbathMode. If you activate this function, some electronic functions are switched off. As a result, your device meets the religious requirements for Jewish holidays such as Sabbath and complies with STAR-K Kosher certification.

Device status when SabbathMode is active
The status display shows SabbathMode permanently.
All functions on the display are locked except for the Deactivate SabbathMode function .
Active functions remain active.
The display remains bright when you close the door.
Reminders are not implemented. The set time interval stops.
Reminders and warnings are not displayed.
There is no door alarm.
There is no temperature alarm.
The defrosting cycle operates only for the specified time, without considering the appliance consumption.
After a power failure, the appliance returns to SabbathMode.

Device status

Note

This appliance has certification from the "Institute for Science and Halacha". (www.machonhalacha.co.il)

You can find a list of STAR-K-certified appliances at www.star-k.org/appliances.

Activating SabbathMode



WARNING

Danger of food poisoning from spoiled food!

If you have SabbathMode activated and a power failure occurs, no message appears in the status display about the power failure. Once the power is restored, the appliance continues to operate in SabbathMode. The power failure may mean that food spoils and the consumption of this food could lead to food poisoning.

After a power failure:

- ▶ Do not consume food that was frozen and has thawed out.



Fig. 32

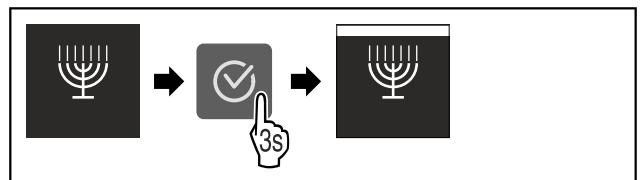

Fig. 33

- ▶ Carry out action steps according to the illustration.
- ▷ SabbathMode is activated.
- ▷ The status display shows SabbathMode permanently.

Deactivating SabbathMode

The SabbathMode is automatically deactivated after 80 hours. However, you can also deactivate SabbathMode manually at any time:

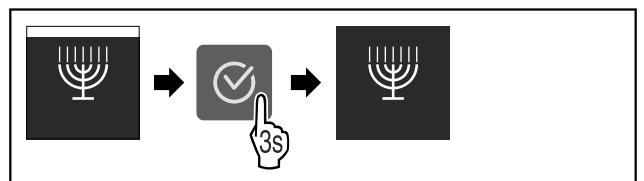

Fig. 34

- ▶ Carry out action steps according to the illustration.
- ▷ SabbathMode is deactivated.



E-Saver

You can use this function to activate or deactivate Energy saving mode. If energy saving mode is activated, the energy consumption decreases and the temperature in the device increases. The food remains fresh, but the shelf life is shortened.

Temperature zone	Recommended setting (see Setting the temperature)	Temperature with active E-Saver
-18°C	-18 °C	-16 °C

Temperatures

Activating E-Saver

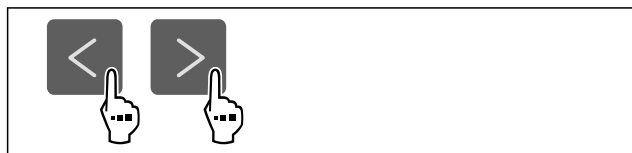

Fig. 35

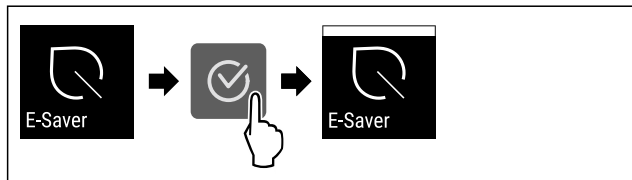

Fig. 36

- ▶ Carry out action steps according to the illustration.
- ▷ Energy saving mode is activated.

Deactivating E-Saver

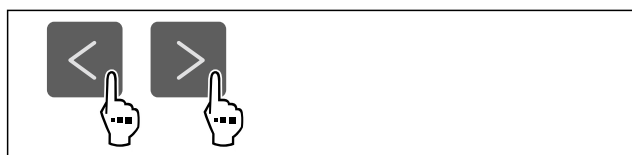

Fig. 37

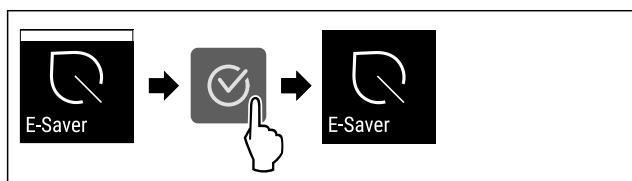

Fig. 38

- ▶ Carry out action steps according to the illustration.
- ▷ Energy saving mode is deactivated.

Display brightness

Use this function to set the display brightness in stages.

You can select the following brightness levels:

- 40 %
- 60 %
- 80 %
- 100 % (pre-setting)

Setting the brightness



Fig. 39

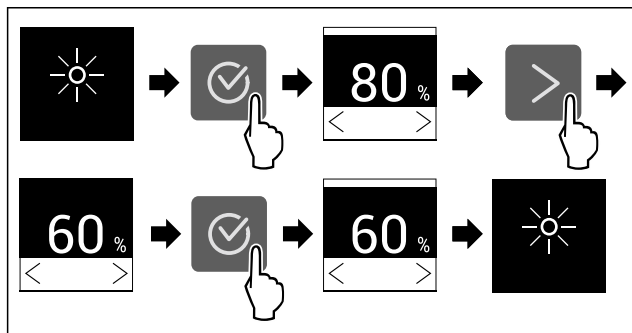

Fig. 40 Example illustration: Switch from 80 % to 60 %.

- ▶ Carry out action steps according to the illustration.
- ▷ The brightness is set.

Door alarm

Use this function to activate or deactivate the door alarm. The door alarm sounds if the door is open for too long. The door alarm is activated on delivery. You can set how long the door may be open before the door alarm sounds.

The following values can be set:

- 1 minute
- 2 minutes
- 3 minutes
- Off

Setting the door alarm



Fig. 41

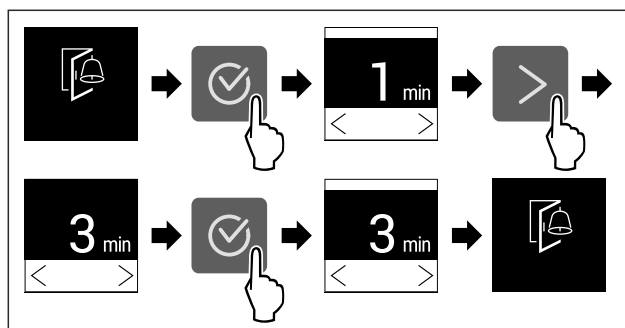

Fig. 42 Example illustration: Change door alarm from 1 minute to 3 minutes.

- ▶ Carry out action steps according to the illustration.
- ▷ The door alarm is set.

Deactivating the door alarm



Fig. 44

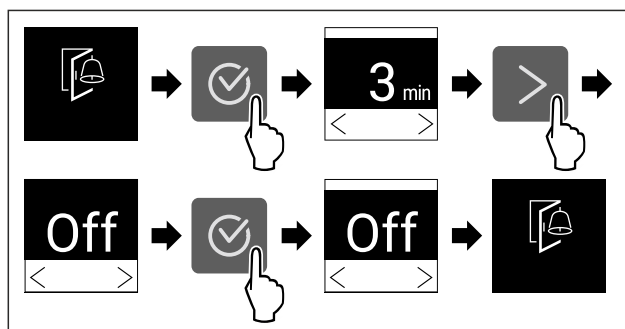

Fig. 45

- ▶ Carry out action steps according to the illustration.
- ▷ The door alarm is deactivated.

Input lock

You can use this function to activate or deactivate the input lock. The input lock prevents the appliance being operated accidentally, e.g. by children.

Controls

Application:

- Avoid unintentional modification of functions.
- Avoid unintentional switching off of the device.
- Avoid unintentional temperature setting.

Activating the input lock

If you activate the input lock, you can continue to navigate in the menus but you cannot select or change other functions.



Fig. 46

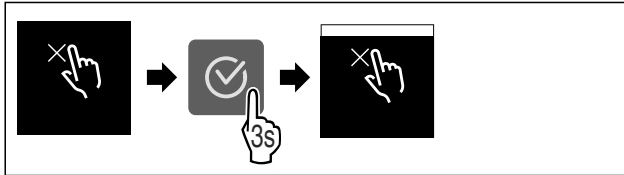

Fig. 47

- ▶ Carry out action steps according to the illustration.
- ▷ Input lock is activated.

Deactivating the input lock



Fig. 48

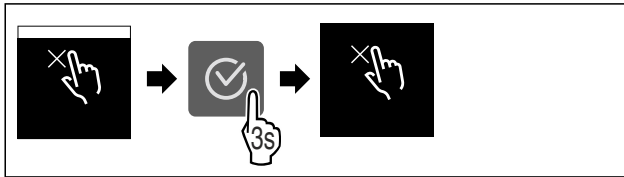

Fig. 49

- ▶ Carry out action steps according to the illustration.
- ▷ Input lock is deactivated.



Device information

Use this function to indicate the model name, index, serial number and service number of your device. You will need the device information when you contact customer service. (see 10.4 Customer Service)

This function also opens the Advanced menu. (see 3 Functionality of the Touch display)

Indicating the device information

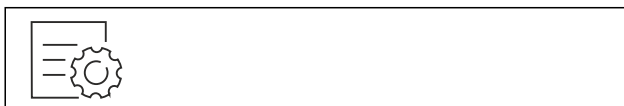

Fig. 50

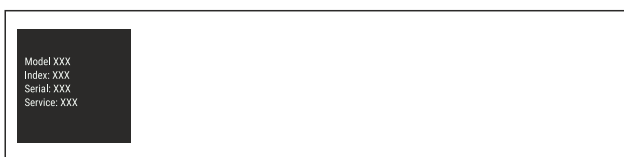

Fig. 51

- ▶ Carry out action steps according to the illustration.
- ▷ Display indicates device information.



Software

Use this function to indicate the software version of your device.

Indicating the software version



Fig. 52



Fig. 53

- ▶ Carry out action steps according to the illustration.
- ▷ Display indicates software version.



Demo mode

Demo mode is a special feature for dealers who want to demonstrate appliance features. If you activate demo mode, all refrigeration functions are deactivated.

If you switch on your appliance and “Demo” appears in the status display, then demo mode is already activated.

If you activate and then deactivate demo mode, the appliance will be reset to factory defaults. (see Resetting to factory settings)

Activating demo mode



Fig. 54

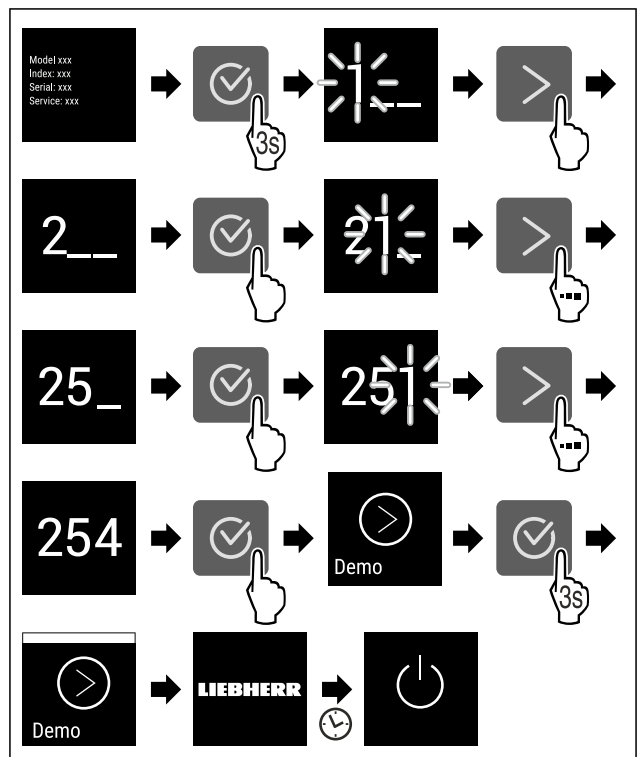

Fig. 55

- ▶ Carry out action steps according to the illustration.
- ▷ Demo mode is activated.
- ▷ Appliance is switched off.
- ▶ Switch on the appliance. (see 4.1 Switching on appliance (first use))
- ▷ "DEMO" appears in the status display.

Deactivating demo mode



Fig. 56

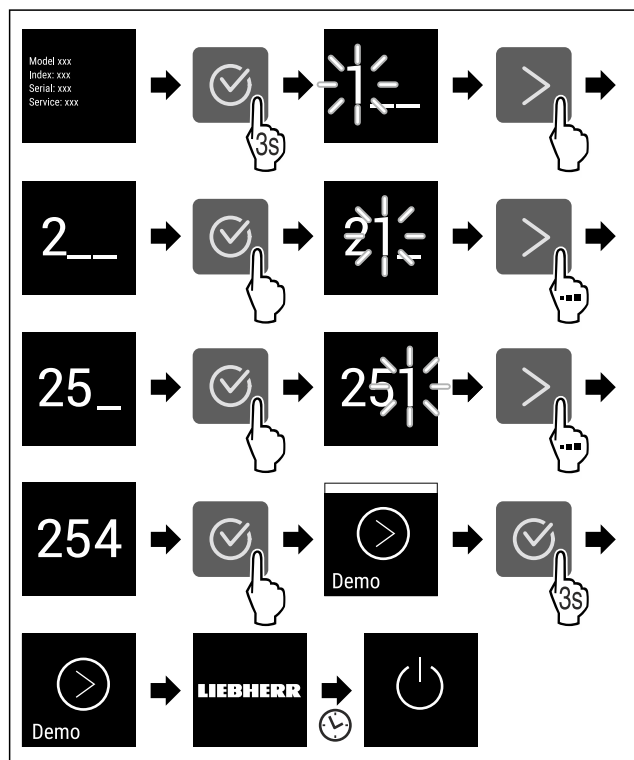

Fig. 57

- ▶ Carry out action steps according to the illustration.
- ▷ Demo mode is deactivated.
- ▷ Appliance is switched off.
- ▶ Switch on the appliance. (see 4.1 Switching on appliance (first use))
- ▷ Appliance is reset to factory settings.

Resetting to factory settings

Use this function to reset all settings to factory defaults. All settings you have made so far are reset to their original settings.

Performing a reset



Fig. 58

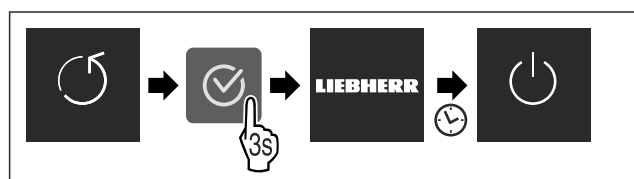

Fig. 59

- ▶ Carry out action steps according to the illustration.
- ▷ Device is reset.
- ▷ Device is switched off.
- ▶ Restart the device. (see 4.1 Switching on appliance (first use))

7.3 Messages



There are two categories of messages:

Category	Importance
Warning	Warnings appear in the event of a door alarm or malfunction. Simple warnings can be cancelled by yourself. In the event of serious malfunctions, you must contact customer service. (see 10.4 Customer Service)
Reminder	Reminders remind you of general processes. You can carry out these operations to end the message.

7.3.1 Overview of warnings

Behaviour of the appliance in the event of warnings:

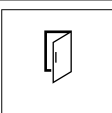
- Warning appears on the display.
- The alarm tone sounds at an ever-increasing volume.

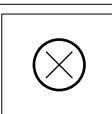
Message	Cause	Exit the message
 Door alarm	The message appears if the door is open for too long.	Carry out action steps (see Door alarm) .
 Power outage alarm	The message appears if the freezing temperature has risen due to a power failure.	Carry out action steps (see Power outage alarm) .
 Temperature alarm	The message appears if the freezing temperature does not correspond to the set temperature.	Carry out action steps (see Temperature alarm) .
 Error	The message appears if there is an appliance error. A component of the appliance has a fault.	Carry out action steps (see Error) .

7.3.2 Ending warnings

Door alarm

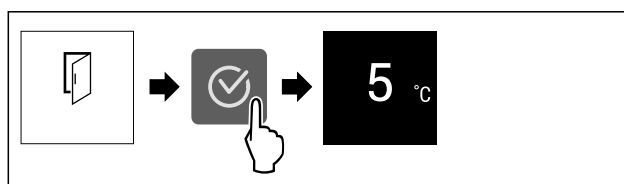

Fig. 60 Example illustration

- ▶ Carry out action steps according to the illustration.
- or-

Features

► Close the door.

▷ The display returns to the status indicator.

You can set how long the door may be open before the door alarm sounds. (see Setting the door alarm)

Power outage alarm

When the power failure has ended, the appliance cools down to the previously set target temperature.

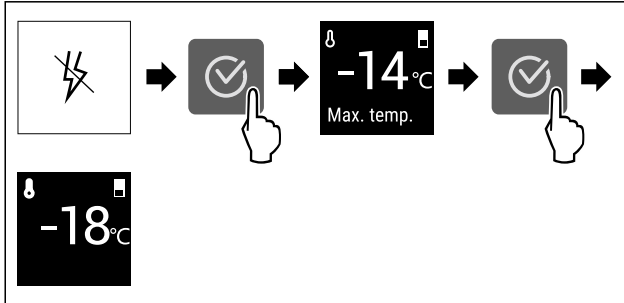

Fig. 61 Example illustration

- Press the confirmation symbol.
- ▷ Warmest freezing temperature is displayed.
- ▷ If the freezing temperature was below -9 °C: Food can still be consumed.
- If the freezing temperature has risen above -9 °C:
- Check the food.
- Press the confirmation symbol.
- ▷ The display returns to the status indicator: Current temperature and target temperature are displayed.

Temperature alarm

Temperature differences can be caused by:

- You have put in warm, fresh food.
- Too much warm air has got in while you were sorting out the freezer or removing items.
- There has been a longer power failure.
- The appliance is faulty.
- Eliminate causes.
- ▷ The appliance cools to the target temperature set previously.

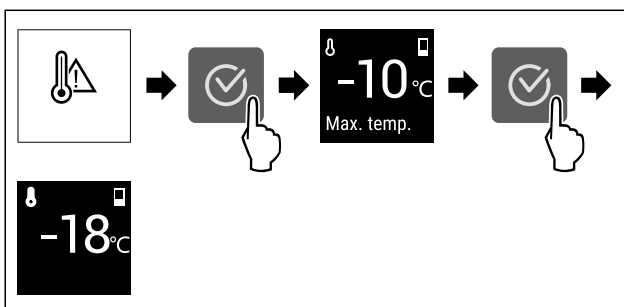

Fig. 62 Example illustration

- Press the confirmation symbol.
- ▷ Warmest freezing temperature is displayed.
- ▷ If the freezing temperature was below -9 °C: Food can still be consumed.
- If the freezing temperature has risen above -9 °C:
- Check the food.
- Press the confirmation symbol.
- ▷ The display returns to the status indicator: Current temperature and target temperature are displayed.

Error

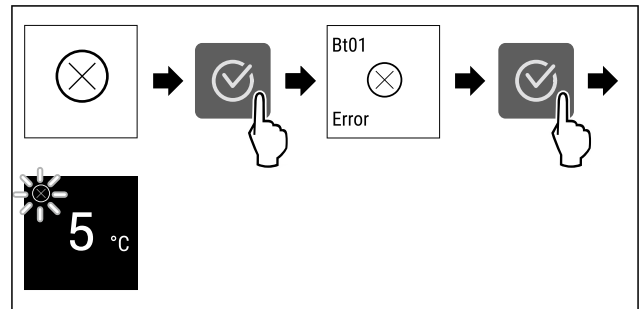

Fig. 63 Example illustration

- Press the confirmation symbol.
- ▷ Error code is displayed.
- Note the error code.
- Press the confirmation symbol.
- ▷ The display returns to the status indicator.
- Contact Customer Service. (see 10.4 Customer Service)

7.3.3 Overview of reminders

Behaviour of the appliance during reminders:

- Reminder appears on the display.
- Alarm tone sounds.

8 Features

8.1 Drawers

You can remove the drawers for cleaning.

You can remove the drawers to use VarioSpace.

The way to remove/insert the drawers varies depending on the pull-out system. Your appliance can contain various pull-out systems.

For appliances with NoFrost:*

Note

The energy consumption increases and the cooling power goes down if ventilation is not sufficient.*

- Leave the bottom drawer in the appliance!*
- Always leave the fan air vents clear on the back wall!*

For appliances without NoFrost:*

Note

The energy consumption increases and the cooling power goes down if ventilation is not sufficient.*

- Always leave the fan air vents clear on the back wall!*

8.1.1 Drawer on appliance base or glass shelf

The drawer runs directly on the appliance base or on a glass shelf. There are no rails.

When you remove the drawers, you can use the glass shelves below them as storage shelves.

Removing drawer

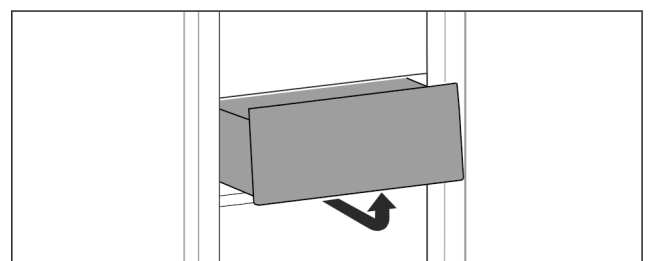

Fig. 64

- ▶ Remove drawer as shown in the illustration.

Inserting drawer

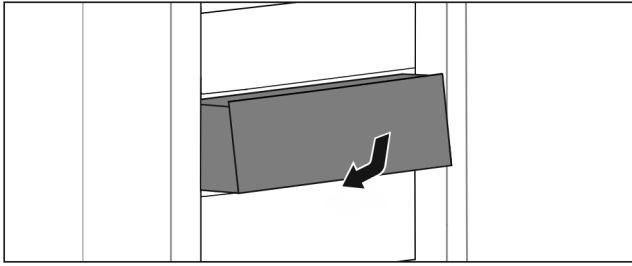

Fig. 65

- ▶ Insert drawer as shown in the illustration.

8.1.2 Top tilting drawer*

When you pull out the top drawer, it tilts forward. This gives you a better view into the drawer. The function depends on the height of the appliance.

When you remove the tilting drawers, you can use the glass shelf below them as a storage shelf.

Removing drawer

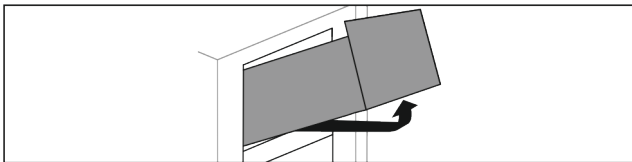

Fig. 66

- ▶ Pull out drawer as far as it will go.
- ▶ Lift drawer up at the front and at the same time push up at the back from below.
- ▶ Remove drawer to the front.

Inserting drawer

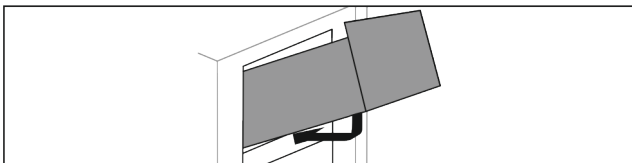

Fig. 67

- ▶ Position drawer as shown.
- ▷ The drawer rests on the glass panel.
- ▶ Lift drawer slightly from below at the back and slide over the lip.
- ▶ Slide in drawer to the back.

8.1.3 Drawer on moulded rib

The drawer runs directly on the moulded rib. There are no rails.

Removing drawer

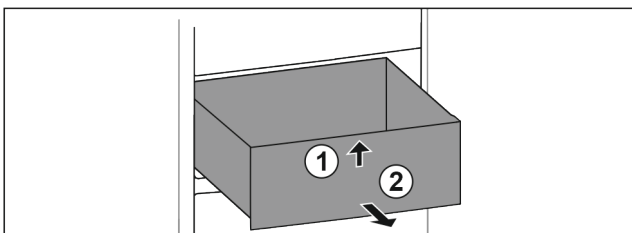

Fig. 68

- ▶ Pull out drawer as far as it will go.
- ▶ Lift up drawer at the front. Fig. 68 (1)
- ▶ Remove drawer to the front. Fig. 68 (2)

Inserting drawer

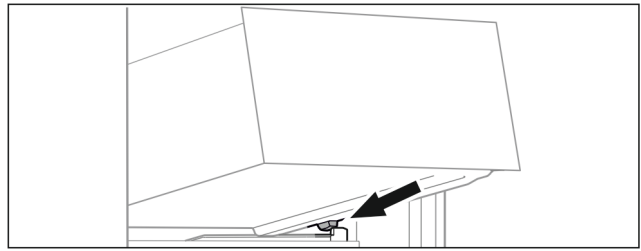

Fig. 69

- ▶ Place drawer at an angle behind the stoppers on the moulded rib. (see Fig. 69)
- ▶ Lower drawer.
- ▶ Slide in drawer to the back.

8.2 Glass shelves

You can remove the glass shelves under the drawers for cleaning.

You can remove the glass shelves under the drawers to use VarioSpace.

8.2.1 Removing / inserting the glass shelf under the tilting drawer*

The glass shelf is located under the top tilting drawer.

Make sure that the following requirements are fulfilled:

- Drawer has been removed. (see 8.1.2 Top tilting drawer*)

Removing glass shelf

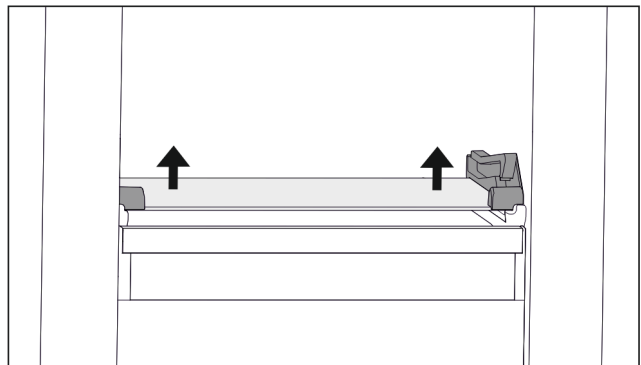

Fig. 70 Tilting drawer glass shelf

- ▶ Push glass shelf upwards from below on both sides. (see Fig. 70)
- ▶ Take out the glass shelf to the front.

Inserting glass shelf

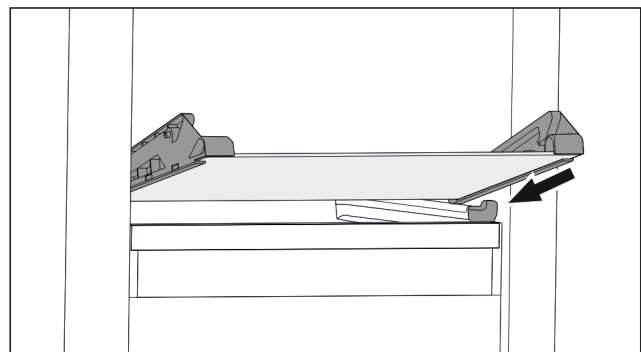

Fig. 71 Tilting drawer glass shelf

- ▶ Position glass shelf at an angle behind the stoppers. (see Fig. 71)
- ▶ Lower glass shelf.
- ▶ Slide in glass shelf to the back.
- ▷ Glass shelf clicks into place.

Maintenance

8.2.2 Removing / inserting the glass shelf

Depending on the equipment, the glass shelf may be located under the drawer.*

Make sure that the following requirements are fulfilled:

- Glass shelf under the drawer: The drawer has been removed. (see 8.1 Drawers)

Removing glass shelf

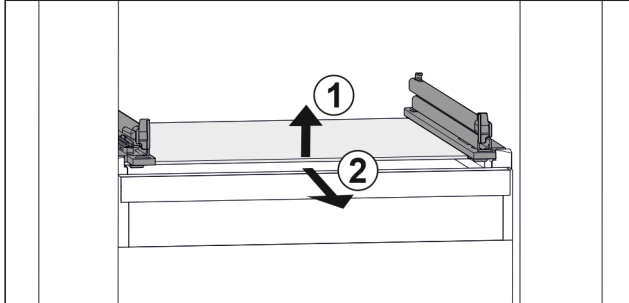

Fig. 72 Example illustration of glass shelf

- ▶ Lift glass shelf at the front. Fig. 72 (1)
- ▶ Take out glass shelf to the front. Fig. 72 (2)

Inserting glass shelf

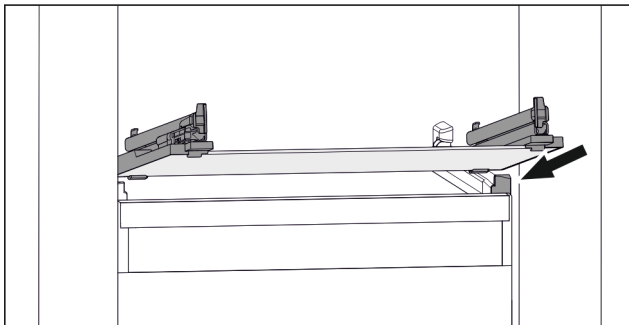

Fig. 73 Example illustration of glass shelf

- ▶ Position glass shelf at an angle behind the stoppers. (see Fig. 73)
- ▶ Lower glass shelf.
- ▶ Slide in glass shelf to the back.

8.3 VarioSpace

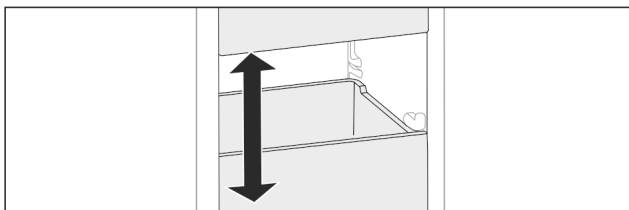

Fig. 74

You can remove drawers and glass panels from your appliance. This provides more room for large food items such as poultry, joints of meat, large game, and tall baked products. You can then freeze these items whole for later preparation.

- ▶ Note the weight limits on the drawers and glass panels (see 10.1 Technical specifications).

9 Maintenance

9.1 Disassembling / assembling pull-out systems

9.1.1 Notes on disassembly

You can disassemble some of the pull-out systems for cleaning. Your appliance can contain a variety of pull-out systems.

The following pull-out systems can be disassembled or cannot be disassembled:

Pull-out system	can be disassembled / cannot be disassembled
Drawer on appliance base or glass shelf	cannot be disassembled
Top tilting drawer*	can be disassembled (see 9.1.2 Top tilting drawer*) *
Drawer on moulded rib	can be disassembled (see 9.1.3 Drawer on moulded rib)

9.1.2 Top tilting drawer*

Disassembling pull-out system

Make sure the following prerequisites are met:

- Drawer has been removed. (see 8.1.2 Top tilting drawer*)
- Glass shelf has been removed. (see 8.2 Glass shelves)

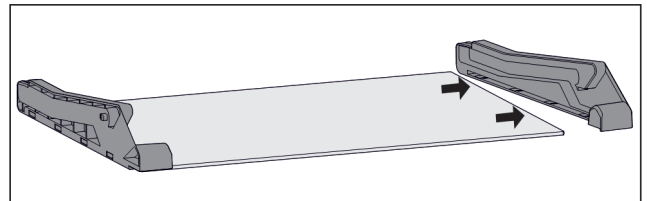

Fig. 75 Glass shelf with side parts

- ▶ Pull off side part from glass shelf sideways.

Installing pull-out system

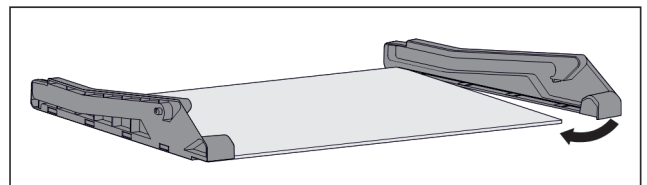

Fig. 76 Glass shelf with side parts

- ▶ Place on side part at the back.
- ▶ Press side part onto glass shelf at the front.

9.1.3 Drawer on moulded rib

Disassembling pull-out system

Make sure the following prerequisites are met:

- Drawer has been removed. (see 8.1.3 Drawer on moulded rib)

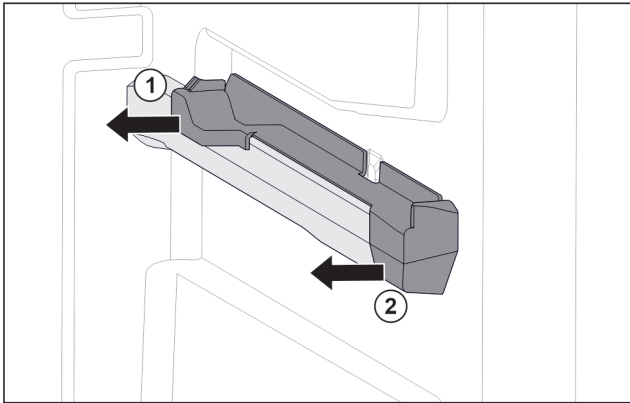

Fig. 77 Attachment on the right moulded rib

- ▶ Grab attachment at the back from below.
- ▶ Pull off attachment at the back sideways. Fig. 77 (1)
- ▶ Pull off attachment at the front sideways. Fig. 77 (2)

Installing pull-out system

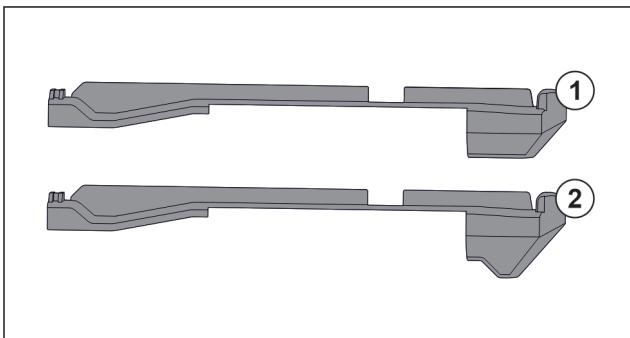

Fig. 78 Comparing attachments

There are two different attachments in the appliance. The attachment above the lowest drawer Fig. 78 (2) has a three-cornered edge. All other attachments Fig. 78 (1) have a straight edge.

- ▶ Fit attachment Fig. 78 (2) with the three-cornered edge above the lowest drawer.
- ▶ Fit attachment Fig. 78 (1) with straight edge in all other positions.

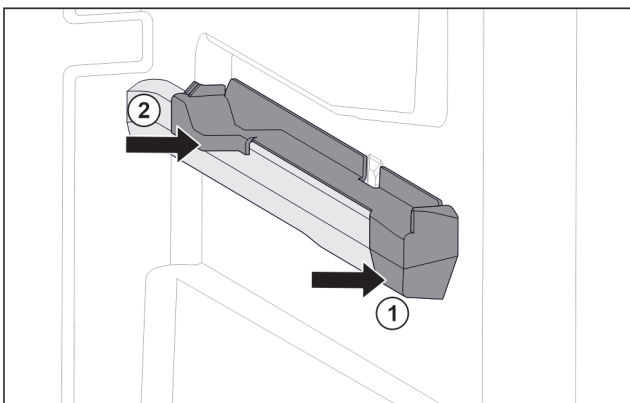

Fig. 79 Attachment on the right moulded rib

- ▶ Position attachment on moulded rib at the front. Fig. 79 (1)
- ▶ Press on attachment at the back. Fig. 79 (2)

9.2 Defrosting the appliance



WARNING

Improper defrosting of the appliance!*
Injuries and damage.

- ▶ Do not use mechanical equipment or other methods to speed up the defrosting process other than those recommended by the manufacturer.
- ▶ Do not use electrical heating or steam-cleaning appliances, naked flames or defroster sprays to defrost.
- ▶ Do not use sharp objects to remove ice.

9.2.1 Defrosting with NoFrost*

Defrosting is performed automatically with the NoFrost system. The moisture is deposited on the evaporator, is periodically defrosted and evaporates.

The appliance does not have to be defrosted.

9.2.2 Defrosting the freezer compartment manually*

9.2.2 Manual defrosting

A layer of frost or ice forms after prolonged use.

The following factors promote the formation of frost or ice:

- The appliance is opened frequently.
- Hot food is put in.

One day before defrosting:

- ▶ Activate SuperFrost. (see 7.2 Appliance functions)
- ▷ Frozen goods have a "residual coldness".
- ▶ Switch the appliance off.
- ▶ Pull the mains plug out of the socket or switch the fuse off.
- ▶ Wrap the frozen produce in newspaper or blankets and store in a cool place.
- ▶ Place a pan of hot water (not boiling) on the middle shelf.

-or-

- ▶ Fill the two bottom drawers half-full with warm water and place them inside the appliance.

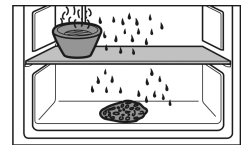

- ▷ This speeds up the defrosting process.
- ▷ Water from the thawing process is collected in the drawers.
- ▶ Leave the appliance door open during defrosting.
- ▶ Remove loosened pieces of ice.
- ▶ Make sure that there is no melted ice water in the cabinet.
- ▶ Soak up the melted ice water with a sponge or cloth several times as necessary.
- ▶ Clean the appliance. (see 9.3 Cleaning the appliance)

9.3 Cleaning the appliance

9.3.1 Ready



WARNING

Danger of electric shock!

- ▶ Remove the refrigerator connector or interrupt the power supply.



WARNING

Risk of fire

- ▶ Do not damage the refrigeration circuit.

Customer help

- ▶ Empty the appliance.
- ▶ Remove mains connector.

9.3.2 Cleaning the interior

NOTICE

Improper cleaning!
Damage to the appliance.

- ▶ Only use soft cleaning cloths and ph-neutral all-purpose cleaners.
- ▶ Do not use abrasive sponges or steel wool which may cause scratches.
- ▶ Do not use any sharp or abrasive cleaning agents, nor any that contain sand, chloride or acid.

- ▶ Plastic surfaces: clean by hand with a soft clean cloth, lukewarm water and a little detergent.
- ▶ Metal surfaces: clean by hand with a soft clean cloth, lukewarm water and a little detergent.

9.3.3 Clean the components

NOTICE

Improper cleaning!
Damage to the appliance.

- ▶ Only use soft cleaning cloths and ph-neutral all-purpose cleaners.
- ▶ Do not use abrasive sponges or steel wool which may cause scratches.
- ▶ Do not use any sharp or abrasive cleaning agents, nor any that contain sand, chloride or acid.

Clean with a soft, clean cloth, lukewarm water and some detergent:

- Drawer
- Freezer tray*

Wash in the dishwasher up to 60 °C:

- Ice cube tray*
- ▶ To disassemble components: see the relevant section.
- ▶ Clean the components.

9.3.4 After cleaning

- ▶ Wipe the appliance and the components dry.
- ▶ Connect and switch on the appliance.
- ▶ Activate SuperFrost (see 7.2 Appliance functions) .
The temperature is cold enough:
- ▶ Place the food inside.
- ▶ Repeat cleaning regularly.

10 Customer help

10.1 Technical specifications

Temperature range	
Freeze	-28 °C to -15 °C
Maximum freezing quantity/24 h	
Freezer compartment	See "Freezing capacity .../24 h" on the type plate

Maximum component capacity			
Features	Appliance width 550 mm (see installation instructions, appliance dimensions)	Appliance width 600 mm (see installation instructions, appliance dimensions)	Appliance width 700 mm (see installation instructions, appliance dimensions)
Drawer on glass shelf (see 8.1.1 Drawer on appliance base or glass shelf)	12 kg	15 kg	--
Drawer on moulded rib (see 8.1.3 Drawer on moulded rib)	14 kg	19 kg	19 kg

10.2 Operating noises

The appliance makes different noises when it is on.

- At **higher temperatures** the appliance uses less energy but works for longer. It is **quieter**.
- At **lower temperatures** the food is cooled faster. It is **louder**.

Examples:

- Functions on (see 7.2 Appliance functions)
- Fan running*
- Food recently added
- High ambient temperature
- Door open for a while

Noise	Possible cause	Type of noise
Bubbling and splashing	Coolant flowing into the cooling circuit.	Normal operating noise
Hissing	Coolant sprays into the cooling circuit.	Normal operating noise
Humming	The appliance is cooling. The volume depends on the cooling output.	Normal operating noise
Suction noises*	Soft-closing door is being opened and closed.*	Normal operating noise*
Humming and rustling*	The fan is running.*	Normal operating noise*
Clicking	Components are switched on and off.	Normal switching noise
Rattling or humming	Valves or flaps are working.	Normal switching noise

Noise	Possible cause	Type of noise	Lifting
Vibration	Improper installation	Defective noise	Check the installation. Level the appliance.
Rattling	Components, items inside the appliance	Defective noise	Secure components. Leave enough space between the items.

10.3 Technical fault

Your appliance is designed and built to ensure it works reliably and has a long service life. In the unlikely event that a fault occurs during operation, please check whether it is due to an operating error. If so, you will be charged for the callout and repair costs even if it falls within the warranty period.

You can fix the following faults yourself.

10.3.1 Appliance function

Defect	Cause	Remedy
The appliance is not working.	→ The appliance is not switched on.	▶ Switch the appliance on.
	→ The power plug is not properly plugged into the socket.	▶ Check the power plug.
	→ There is something wrong with the power outlet fuse.	▶ Check the fuse.
	→ Power cut	▶ Keep the appliance closed. ▶ Protecting food: Lay freezer packs on top of the food or use another freezer if the power is off for a prolonged period. ▶ Do not re-freeze defrosted food,
	→ The appliance plug does not fit the appliance properly.	▶ Check the appliance plug.
Temperature is not cold enough.	→ The appliance door is not closed properly.	▶ Close the appliance door.
	→ Not enough ventilation.	▶ Keep ventilation grille clear, and clean it.
	→ The ambient temperature is too high.	▶ Problem solution: (see 1.4 Appliance range of use)
	→ The appliance was opened too many times or for too long.	▶ Wait to see if the required temperature corrects itself. If not, contact Customer Service. (see 10.4 Customer Service)
	→ Too much fresh food was placed inside without SuperFrost.	▶ Solution: (see SuperFrost)
	→ The temperature is set incorrectly.	▶ Turn down the temperature and check after 24 hours.
	→ The appliance is too close to a heat source (oven, radiator, etc).	▶ Move the appliance or the heat source.
	→ The appliance was not correctly installed in the recess.	▶ Check if the appliance was installed correctly and that the door closes properly.
The door seal is defective or needs to be replaced for another reason.	→ The door seal can be replaced. It can be replaced without the need for special tools.	▶ Contact Customer Service. (see 10.4 Customer Service)
The appliance builds up too much ice or condensation.	→ The door seal may have slipped out of its groove.	▶ Check that the door seal is well fitted in the groove.
Concentrated collection of ice on inside face at centre of appliance cover.*	→ This build-up of ice is normal. Physical properties cause ice to build up inside the top of the appliance.	▶ Remove the ice with a scraper tool.

Shutting down

10.4 Customer Service

First check whether you can rectify the fault yourself (see 10 Customer help) . If you cannot rectify the problem, contact Customer Service.

You can find the address in the enclosed brochure "Liebherr-Service" or at home.liebherr.com/service.



WARNING

Unprofessional repair!
Injuries.

- ▶ Have any repairs and action - not expressly specified - on the appliance and mains cable carried out by service personnel only. (see 9 Maintenance)
- ▶ A damaged mains cable may only be replaced by the manufacturer, the manufacturer's Customer Service or a similarly qualified person.
- ▶ In the case of appliances with an IEC connector, the change may be made by the customer.

10.4.1 Contacting Customer Service

Make sure that the following appliance information is available:

- Appliance name (model and index)
- Service no. (Service)
- Serial no. (S no.)
- ▶ Call up the appliance information via the display. (see Device information)

-or-

- ▶ Refer to the type plate for appliance information. (see 10.5 Model plate)
- ▶ Note down the appliance information.
- ▶ Notify customer service: Report errors and the appliance information.
- ▷ This will help us to provide you with a faster, more accurate service.
- ▶ Follow further instructions from Customer Service.

10.5 Model plate

The model plate is behind the drawers on the inside of the appliance.

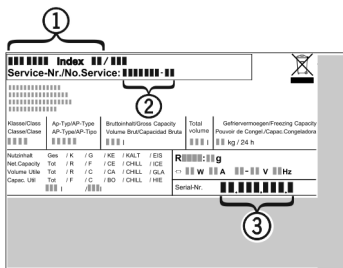

Fig. 80

- (1) Appliance description (3) Serial no.
- (2) Service no.

- ▶ Note the data on the model plate.

11 Shutting down

- ▶ Empty the appliance.
- ▶ Switch off appliance. (see Switching the appliance off and on)
- ▶ Pull the mains plug out of the socket.
- ▶ Remove the IEC socket if required: Pull the IEC socket out of the appliance plug and move it to the left and right at the same time.
- ▶ Clean appliance. (see 9.3 Cleaning the appliance)

- ▶ Leave the door open, so that no unpleasant odours arise.

12 Disposal

12.1 Preparing appliance for disposal



Liebherr uses batteries in some of its appliances. In the EU, for environmental reasons, legislation obliges the end user to remove these batteries before disposing of old appliances. If your appliance contains batteries, a corresponding notice is attached.

Lamps

If you can remove the lamps yourself without destroying them, also remove these before disposal.

- ▶ Take the appliance out of operation.
- ▶ Appliances with batteries: remove the batteries. For description, see **Maintenance** chapter.
- ▶ If possible: remove lamps without destroying them.

12.2 Disposing of the appliance in an environmentally friendly manner



The appliance still contains valuable materials and must be disposed of separately from unsorted municipal waste.



Dispose of batteries separately from the old appliance. To do this, you can return the batteries free of charge to retailers as well as recycling centres and collection centres for recyclable materials.

Lamps

Dispose of removed lamps via the respective collection systems.

For Germany:

You can dispose of the appliance free of charge via the class 1 collection containers at the local recycling and recyclable material collection centres. When purchasing a new fridge/freezer, if the sales area > 400 m², retailers will also take back the old appliance free of charge.



WARNING

Leaking coolant and oil!
Fire. The coolant contained in the appliance is eco-friendly, but also flammable. The oil contained in the appliance is flammable. Escaping coolant and oil can ignite if the concentration is high enough and in contact with an external heat source.

- ▶ Do not damage the pipelines of the coolant circuit and the compressor.

- ▶ Observe the notes on transporting the appliance.
- ▶ Transport the appliance without damaging it.
- ▶ Dispose of batteries, lamps and the appliance according to the above specifications.



home.liebherr.com/fridge-manuals

EN Integrated freezer

Issue date: 20240528

Part number index: 7088439-00

Liebherr-Hausgeräte GmbH
Memminger Straße 77-79
88416 Ochsenhausen
Deutschland

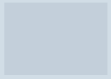

User Guide

Quality, Design and Innovation

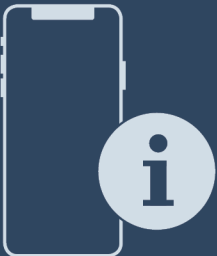



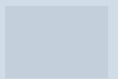
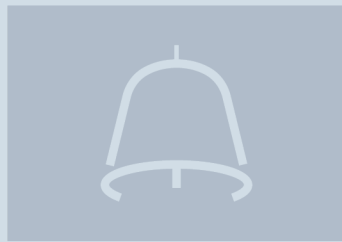











home.liebherr.com/fridge-manuals



LIEBHERR

Contents

1	Appliance at a glance.....	3
1.1	Scope of delivery.....	3
1.2	Overview of appliances and equipment.....	3
1.3	SmartDevice.....	3
1.4	Appliance range of use.....	4
1.5	Conformity.....	4
1.6	SVHC substances according to REACH regulation.....	4
1.7	EPREL database.....	4
2	General safety instructions.....	5
3	Functionality of the Touch display.....	6
3.1	Navigation and symbol explanation.....	6
3.2	Menus.....	6
3.3	Sleep mode.....	7
4	Putting into operation.....	7
4.1	Switching on appliance (first use).....	7
5	Storage.....	7
5.1	Information regarding storage.....	7
5.2	Fridge compartment.....	8
5.3	EasyFresh.....	8
5.4	****-freezer compartment*.....	8
5.5	Storage times.....	8
6	Saving energy.....	8
7	Controls.....	9
7.1	Controls and displays.....	9
7.1.1	Status display.....	9
7.1.2	Display symbols.....	9
7.2	Appliance functions.....	9
7.2.1	Notes on the appliance functions.....	9
	Switching the appliance off and on.....	9
	WiFi.....	9
	Temperature.....	10
	Temperature unit.....	11
	C-Value*.....	11
	SuperCool.....	11
	PowerCool *.....	12
	PartyMode.....	12
	HolidayMode.....	13
	SabbathMode.....	13
	E-Saver.....	14
	CleaningMode.....	14
	Display brightness.....	14
	Door alarm.....	15
	Input lock.....	15



Device information.....	16
Software.....	16
Reminder*.....	16
Demo mode.....	16
Resetting to factory settings.....	17
7.3 Messages.....	17
7.3.1 Overview of warnings.....	17
7.3.2 Ending warnings.....	18
7.3.3 Overview of reminders.....	18
7.3.4 Ending reminders.....	18
8 Features.....	18
8.1 4-star freezer compartment*.....	18
8.2 Door rack.....	19
8.3 Shelves.....	19
8.4 Dividing shelf*.....	19
8.5 VarioSafe *.....	20
8.6 Space for baking tray*.....	22
8.7 Drawers.....	22
8.8 EasyFresh-Safe cover.....	23
8.9 Adjusting the moisture levels.....	23
8.10 Pull-out board with bottle basket*.....	24
8.11 Glass shelves*.....	24
8.12 Bottle holder.....	25
9 Maintenance.....	25
9.1 FreshAir carbon filter*.....	25
9.2 Disassembling / assembling pull-out systems.....	26
9.3 Defrosting the appliance.....	26
9.4 Defrosting the freezer compartment manually*.....	26
9.5 Cleaning the appliance.....	26
10 Customer help.....	27
10.1 Technical specifications.....	27
10.2 Operating noises.....	27
10.3 Technical fault.....	28
10.4 Customer Service.....	29
10.5 Model plate.....	29
11 Shutting down.....	29
12 Disposal.....	29
12.1 Preparing appliance for disposal.....	29
12.2 Disposing of the appliance in an environmentally friendly manner.....	30

The manufacturer is continually working on the further development of all types and models. Please be aware that we reserve the right to make changes to the shape, equipment and technology.

Symbol	Explanation
	Read instructions Please read the information in these instructions carefully to understand all of the benefits of your new appliance.

Symbol	Explanation
	<p>Additional information on the Internet</p> <p>The digital manual with additional information and in other languages can be found via the QR code on the front of the manual or by entering the service number at home.liebherr.com/fridge-manuals.</p> <p>The service number can be found on the serial tag:</p> <p style="text-align: center;"><i>Fig. Example illustration</i></p>
	<p>Check appliance</p> <p>Check all parts for transport damage. If you have any complaints, please contact your agent or customer service.</p>
	<p>Differences</p> <p>These instructions apply to a range of models, so differences are possible. Sections that apply to certain models only are marked with an asterisk (*).</p>
	<p>Instructions and results</p> <p>Instructions are marked with a ►.</p> <p>Results are marked with a ▷.</p>
	<p>Videos</p> <p>Videos about the appliances are available on the YouTube channels of Liebherr-Hausgeräte.</p>

These operating instructions apply to:

DR..	39.. / 41..
IR..	40.. / 41.. / 45.. / 51..
IRD..i	51..
IR(S)..	39.. / 41..
IKS 41Ve00	
IKS 41Ve01	
IK 51Ve00	
IK 51Ve01	
IK.	1780 / 1784

1 Appliance at a glance

1.1 Scope of delivery

Check all parts for transport damage. Contact your dealer or customer service in the event of complaints. (see 10.4 Customer Service)

Your new appliance comes with the following parts:

- Built-in appliance
- Features (depending on the model)
- Installation materials (depending on the model)
- "Quick Start Guide"

- "Installation Guide"
- Service Brochure

1.2 Overview of appliances and equipment

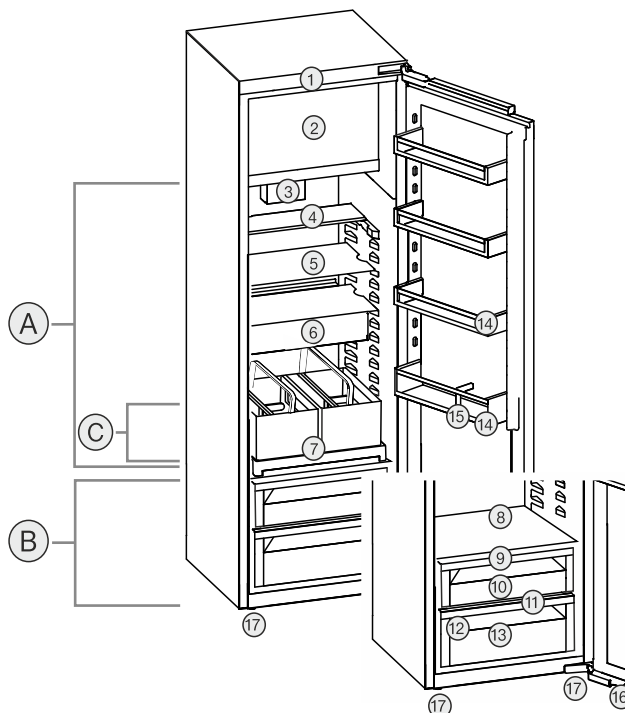

Fig. 1 Example illustration

Temperature range

- (A) Fridge compartment (B) EasyFresh
(C) Coldest zone

Equipment

- | | |
|--|------------------------|
| (1) Controls | (10) EasyFresh-Safe |
| (2) 4-star freezer compartment* | (11) Drain hole |
| (3) Fan with FreshAir activated charcoal filter* | (12) Type plate |
| (4) Divisible storage shelf* | (13) Vegetable drawer* |
| (5) Storage shelf | (14) Door shelf |
| (6) VarioSafe* | (15) Bottle holder |
| (7) Pull-out board with bottle basket* | (16) Closing damper* |
| (8) Space for baking tray* | (17) Adjusting feet |
| (9) Lid for EasyFresh-Safe | |

Note

- Shelves, drawers and baskets are arranged for optimum energy efficiency when the appliance is delivered. Changing how the shelves, for example, are inserted in the fridge compartment does not have any impact on energy consumption.

1.3 SmartDevice

SmartDevice is the networking solution for your refrigerator. If your appliance SmartDevice-enabled or compatible, you can quickly and easily connect your appliance to your WiFi. With the SmartDevice app, you can operate your appliance from a mobile device. Additional functions and setting options are available in the SmartDevice SmartDevice app.

Appliance at a glance

SmartDevice-enabled appliance:* Your appliance is capable of being a SmartDevice. To be able to connect your device to WiFi, you need to download the SmartDevice app.*

SmartDevice-compatible appliance:* Your appliance is compatible for use with the SmartDeviceBox. You must first purchase and install the SmartDeviceBox. In order to connect your appliance to the WiFi, you need to download the SmartDevice app.*



More information about SmartDevice: smartdevice.liebherr.com

Purchasing the SmartDeviceBox in the Liebherr-Hausgeräte store:* home.liebherr.com/shop/de/deu/smartdevicebox.html*

Downloading the SmartDevice app:



After installing and configuring the SmartDevice, you can connect your appliance to the WiFi using the SmartDevice app and the WiFi appliance function (see WiFi).

Note

The SmartDevice function is not available in the following countries: Russia, Belarus, Kazakhstan.

You cannot use the SmartDeviceBox.*

1.4 Appliance range of use

Intended use

The appliance is only suitable for cooling food products in a domestic or household-like environment. This includes, for example, use:

- in staff kitchens, bed and breakfast establishments,
- by guests in country houses, hotels, motels and other accommodation,
- for catering and similar services in the wholesale trade.

The appliance is not suitable for freezing food;*

All other types of use are not permitted.

Foreseeable misuse

The following applications are expressly forbidden:

- Storing and refrigerating medicines, blood plasma, laboratory preparations or similar

substances and products based on the Medical Device Directive 2007/47/EC

- Use in areas at risk of explosions

Misusing the appliance may lead to damage to the goods stored or they may spoil.

Climate classifications

Depending on the climate classification the appliance is designed to operate in restricted ambient temperatures. The climate classification applying to your appliance is printed on the rating plate.

Note

- Keep to the specified ambient temperatures in order to guarantee that the appliance works properly.

Climate classification	for ambient temperatures of
SN	10 °C to 32 °C
N	16 °C to 32 °C
ST	16 °C to 38 °C
T	16 °C to 43 °C
SN-ST	10 °C to 38 °C
SN-T	10 °C to 43 °C

1.5 Conformity

The refrigerant circuit has been tested for leaks. When installed, the appliance complies with the applicable safety regulations and with the corresponding directives.

For the market:* EU The appliance complies with directive 2014/53/EU.*

For the market:* GB The appliance complies with Radio Equipment Regulations 2017 SI 2017 No. 1206.*

The full text of the EU Declaration of Conformity is available on the following website: www.Liebherr.com

1.6 SVHC substances according to REACH regulation

You can check whether your appliance contains SVHC substances according to REACH regulation at the following link: home.liebherr.com/de/deu/de/liebherr-erleben/nachhaltigkeit/umwelt/scip/scip.html

1.7 EPREL database

Details about energy labelling and ecodesign requirements will be available on the European product database (EPREL) from 1st March 2021. You can access the product database at the following link: <https://eprel.ec.europa.eu/> You will be asked to enter the model ID. You can find the model ID on the nameplate.

2 General safety instructions

Please keep these operating instructions in a safe place so you can refer back to them at any time.

If you pass the appliance on, please hand these operating instructions to the next user.

Read these operating instructions carefully before use to ensure safe and correct use of the appliance. Follow the instructions, safety instructions and warning messages included at all times. They are important for ensuring you can operate and install the appliance safely and without any problems.

Danger for the user:

- This device can be used by children and people with impaired physical, sensory or mental abilities or with a lack of experience and knowledge provided that they are supervised or have received instruction in the safe use of this device, and about the resulting hazards.

Children must not play with this appliance. Cleaning and user maintenance work must not be carried out by children without adult supervision. Children aged between 3 and 8 are allowed to load and unload the appliance. Children below the age of 3 must be kept away from the appliance unless they are under continuous adult supervision.

- The socket must be easily accessible so that the appliance can be disconnected quickly from the electricity in an emergency. It must not be located in the area behind the appliance.
- When disconnecting the appliance from the supply, always take hold of the plug. Do not pull the cable.
- In the event of a fault pull out the mains plug or deactivate the fuse.
- Do not damage the mains power cable. Do not operate the appliance with a defective mains power cable.
- Only customer service or other specially trained staff may repair or perform other operations on the appliance.
- Only install, connect and dispose of the appliance according to the instructions.
- Only use the appliance when is installed.

Fire hazard:

- The coolant used (information on the model plate) is ecofriendly but also flammable. Any leaking coolant may ignite.
 - Do not damage the refrigerant circuit pipes.

- Do not handle ignition sources inside the appliance.
- Do not use electrical appliances inside the appliance (e.g. steam cleaners, heaters, ice cream makers, etc.).
- If the refrigerant leaks: remove any naked flames or ignition sources from the vicinity of the leakage point. Properly air the room. Inform customer services.
- Do not store explosives or sprays using combustible propellants such as butane, propane, pentane, etc. in the appliance. To identify these spray cans, look for the list of contents printed on the can, or a flame symbol. Gases possibly escaping may ignite due to electrical components.
- Keep burning candles, lamps and other items with naked flames away from the appliance so that they do not set the appliance on fire.
- Please be sure to store alcoholic drinks or other packaging containing alcohol in tightly closed containers. Any alcohol that leaks out may be ignited by electrical components.

Danger of tipping and falling:

- Do not misuse the plinth, drawers, doors etc. as a step or for support. This applies particularly to children.

Danger of food poisoning:

- Do not consume food which has been stored too long.

Danger of frostbite, numbness and pain:

- Avoid prolonged skin contact with cold surfaces or refrigerated/frozen goods or take protective measures, e.g wear gloves.

Danger of injury and damage:

- Hot steam can lead to injury. Do not use electrical heating or steam cleaning equipment, open flames or defrosting sprays to defrost.
- Do not use sharp implements to remove the ice.

Risk of crushing:

- Do not hold the hinge when opening and closing the door. Fingers may get caught.

Symbols on the appliance:



This symbol may be located on the compressor. It relates to the oil in the compressor and makes reference to the risk that: Swallowing or inhaling can be fatal. This advice is only relevant to recycling. There is no danger in normal operation.

Functionality of the Touch display



This symbol is located on the compressor and indicates the danger of flammable materials. Do not remove the sticker.



This or a similar sticker may be located on the rear of the appliance. This sticker indicates that there are vacuum insulation panels (VIP) or perlite panels in the door and/or housing. This advice is only relevant to recycling. Do not remove the sticker.

Please note the warning messages and other specific advice in the other chapters:

	DANGER	indicates an immediately hazardous situation which will lead to death or serious injuries if it is not avoided.
	WARNING	indicates a hazardous situation which may lead to death or serious injuries if it is not avoided.
	CAUTION	indicates a hazardous situation which may lead to minor or moderate injuries if it is not avoided.
	NOTICE	indicates a hazardous situation which may lead to damage to property if it is not avoided.
	Note	indicates useful instructions and tips.

3 Functionality of the Touch display

You operate your appliance using the Touch display. You select appliance functions in the Touch display (hereafter referred to as display) by tapping them. If you do not perform any action on the display for 10 seconds, the display either jumps back to the higher-level menu or directly to the status display.

3.1 Navigation and symbol explanation

In the illustrations, different symbols are used to navigate the display. The following table describes these symbols.

Symbol	Description
	Press the Next navigation arrow: Navigates to the next option in the menu.
	Press the Back navigation arrow: Jumps back one option in the menu.
	Press the navigation arrow several times in succession: Navigates in the menu to the desired function.

Symbol	Description
	Press the Confirm symbol: Activates/deactivates function. Opens submenu.
	Press the Confirm symbol together with the back icon: Jumps back one menu level.
	Arrow with clock: It takes more than 10 seconds for the following message to appear in the display.
	Arrow with a time indication: It takes the specified amount of time until the following message appears in the display.
	"Open Settings menu" symbol: Navigates to the Settings menu and opens the settings menu. If necessary: Navigate to the desired function in the Settings menu. (see 3.2.1 Opening the Settings menu)
	"Open Advanced menu" symbol: Navigates to the Advanced menu and opens the advanced menu. If necessary: Navigate to the desired function in the Advanced menu. (see 3.2.2 Opening the Advanced menu)
No action for 10 seconds	If you do not perform any action on the display for 10 seconds, the display either jumps back to the higher-level menu or directly to the status display.
Opening door and closing it again	If you open the door and immediately close it again, the display jumps directly back to the status display.

Note: Illustrations of the display are shown in the English version.

3.2 Menus

The appliance functions can be found in various menus.

Menu	Description
Main menu	When you switch the appliance on, you are automatically in the main menu. From here you can navigate to the most important appliance functions, to the Settings menu and to the Advanced menu.

Menu	Description
 Settings menu	The Settings menu contains additional appliance functions for setting up your appliance. (see 3.2.1 Opening the Settings menu)
Advanced menu	The advanced menu contains special appliance functions for setting up your appliance. Access to the Advanced menu is protected by the numerical code 151 . (see 3.2.2 Opening the Advanced menu)

3.2.1 Opening the Settings menu

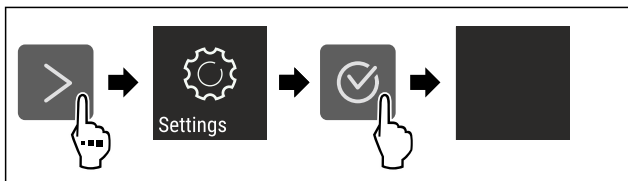

Fig. 2 Example illustration

- ▶ Carry out action steps according to the illustration.
- ▷ Settings menu is open.
- ▶ If necessary: Navigate to the desired function.

3.2.2 Opening the Advanced menu



Fig. 3

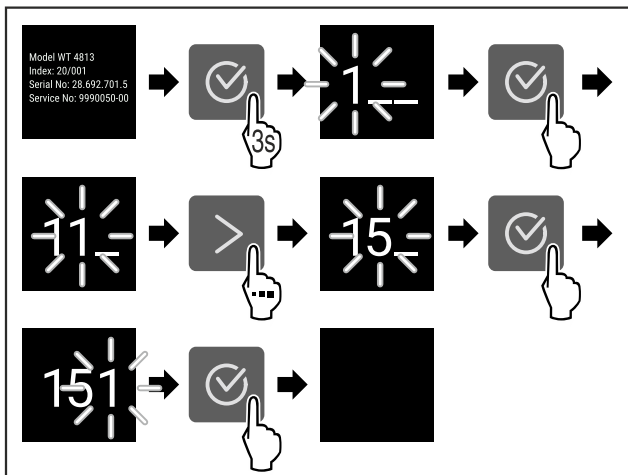

Fig. 4 Example illustration, access with numerical code 151

- ▶ Carry out action steps according to the illustration.
- ▷ The expanded menu is open.
- ▶ If necessary: Navigate to the desired function.

3.3 Sleep mode

If you do not touch the display for 1 minute, the display switches to sleep mode. In sleep mode, the display brightness is dimmed.

3.3.1 Ending sleep mode

- ▶ Press any navigation key.
- ▷ Sleep mode is ended.

4 Putting into operation

4.1 Switching on appliance (first use)

Make sure that the following requirements are fulfilled:

- The appliance is properly installed and connected according to the installation instructions.
- All adhesive strips, adhesive and protective films and transport locks are removed from inside and on the appliance.
- All marketing leaflets are removed from the drawers.
- You are familiar with the functionality of the Touch display. (see 3 Functionality of the Touch display)

Switch on the appliance using the Touch display:

- ▶ If the display is in sleep mode: Briefly touch the display.
- ▶ Carry out action steps according to the illustration.

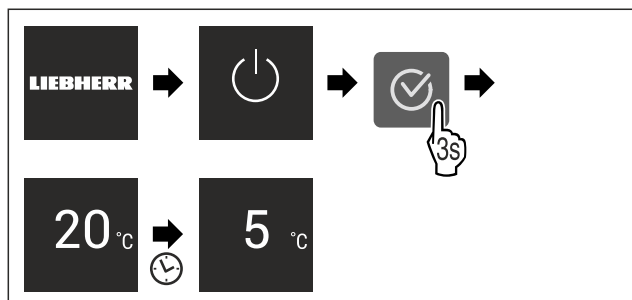

Fig. 5 Example illustration

- ▷ Status display appears.
- ▷ The appliance cools to the temperature set at the factory.
- ▷ The appliance starts in demo mode (status display with DEMO appears): If the appliance starts in demo mode, you can deactivate demo mode within the next 5 minutes. (see Demo mode)

More information:

- Start the SmartDevice for the first time. (see 1.3 Smart-Device) and (see WiFi)

Note

The manufacturer recommends:

- ▶ Stock with food: Wait for around 6 hours until the set temperature is reached.
- ▶ **Store frozen foods** at -18 °C or colder.*
- ▶ Observe the notes on storing food. (see 5.1 Information regarding storage)

Note

Accessories can be purchased from the Liebherr-Hausgeräte store at home.liebherr.com/shop/de/deu/zubehor.html.

5 Storage

5.1 Information regarding storage



WARNING

Risk of fire

- ▶ Do not use any electrical appliances in the food area of the appliance unless recommended by the manufacturer.

Note

The energy consumption increases and the cooling power goes down if ventilation is not sufficient.

- ▶ Always keep air slots clear.

Saving energy

Observe the following specifications for storage:

- Keep the air vents on the fan free.*
- In the freezer compartment: Package food properly.*
- Package or cover foods that readily take on or give off odours or taste in closed containers.
- Package raw meat or fish in clean, closed containers. This will prevent meat or fish from touching or dripping onto other food.
- Keep liquids in closed containers.
- Leave space between goods to ensure good air circulation.
- Store food according to the instructions on the packaging.
- Always observe the best-before date indicated on the packaging.

Note

Failure to follow these guidelines can lead to foodstuffs spoiling.

5.2 Fridge compartment

The air circulation in the appliance creates different temperature zones. You will find the different temperature zones in the appliance and equipment overview. (see 1.2 Overview of appliances and equipment)

5.2.1 Arranging your food properly

- ▶ Upper area and door: Store butter, cheese, tinned food and tubes.
- ▶ Coldest temperature zone: Store perishable foods such as pre-cooked meals, meat and lunch meats.
- ▶ Bottom shelf: Store raw meat or fish.

5.3 EasyFresh

EasyFresh is great for non-packaged foods, such as fruit and vegetables.

The humidity in the compartment depends on the moisture content of the chilled goods placed in it, and also depends on how often the compartment is opened. You can regulate the humidity level. (see 8.9 Adjusting the moisture levels)

5.3.1 Arranging your food properly

- ▶ Store unpackaged fruit and vegetables. If the humidity is too high:
- ▶ Regulate the humidity. (see 8.9 Adjusting the moisture levels)

5.4 ****-freezer compartment*

Here, a dry, frosty storage climate is created at -18 °C. The frosty storage climate is suitable for storing frozen food for several months, for making ice cubes or freezing fresh food.

The air temperature in the freezer compartment, measured with a thermometer or other measuring device, may fluctuate. Temperature fluctuations are greater in a half-full or empty freezer and it is possible to attain temperatures warmer than -18 °C.

5.4.1 Freezing food

The maximum amount of fresh food that you can freeze within 24 hours is specified on the type plate (see 10.5 Model plate) under "Freezing capacity ... kg/24h".

To ensure that food quickly freezes through, adhere to the following quantities per package:

- Fruit and vegetables up to 1 kg
- Meat up to 2.5 kg

Arranging your food properly



CAUTION

Risk of injury due to broken glass! Bottles and cans containing drinks may burst when being frozen. This applies particularly to sparkling drinks.

- ▶ Do not freeze bottles and cans containing drinks!

- ▶ Place packaged food in the freezer compartment.

Defrosting food



WARNING

Risk of food poisoning!

- ▶ Do not re-freeze thawed food.
- ▶ Use defrosted foodstuff as soon as possible.

You can defrost food in several ways:

- In the fridge compartment
- In the microwave
- In the oven/fan-assisted oven
- At room temperature
- ▶ Take out only as much food as necessary.

5.5 Storage times

Refer to the specified storage times as a guide.

In the case of foods with a minimum shelf life, the date indicated on the packaging still applies.

5.5.1 Fridge section

Always follow the best-before date stated on the packaging.

5.5.2 Freezer compartment*

Recommended shelf-lives for various types of food		
Ice cream	at -18 °C	2 to 6 months
Cold cuts, ham	at -18 °C	2 to 3 months
Bread, baked goods	at -18 °C	2 to 6 months
Game, pork	at -18 °C	6 to 9 months
Fatty fish	at -18 °C	2 to 6 months
Lean fish	at -18 °C	6 to 8 months
Cheese	at -18 °C	2 to 6 months
Poultry, beef	at -18 °C	6 to 12 months
Vegetables, fruit	at -18 °C	6 to 12 months

6 Saving energy

- Pay attention to good ventilation. Do not cover ventilation holes or grids.
- Always keep the fan air slits clear.*
- Do not install the appliance in direct sunlight or near radiators or similar sources of heat.
- If the appliance is installed directly next to an oven, the energy consumption may increase slightly. This is dependent on the service life and usage intensity of the oven.

- Energy consumption depends on the installation conditions, e.g. the ambient temperature (see 1.4 Appliance range of use) . A warmer ambient temperature can increase the energy consumption.
- Open the appliance for as short a time as possible.
- The lower the temperature is set the higher the energy consumption.
- Sort your food: home.liebherr.com/food.
- Keep all food properly packed and covered. This prevents frost from forming.
- Only take food out for as long as necessary so that it doesn't warm up too much.
- Inserting warm food: allow to cool down to room temperature first.
- Thaw frozen food in the refrigerator.*
- If there is a thick layer of frost in the appliance: defrost the appliance.*
- For longer periods of absence, use HolidayMode (see HolidayMode) .

7 Controls

7.1 Controls and displays

7.1.1 Status display

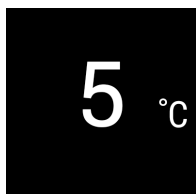





Fig. 6

- ❶ Temperature display of the fridge section

The Status display shows the set temperature and is the home display. From there, you can navigate to the options and settings.

7.1.2 Display symbols

Display symbols provide information on the current appliance status:

Symbol	Appliance status
	Standby The appliance or temperature zone is switched off.
	Flashing number Appliance is working. Temperature flashes until the set value is reached.
	Flashing symbol Appliance is working. Setting is made.
	Bar grows steadily Function is activated.

7.2 Appliance functions

7.2.1 Notes on the appliance functions

The appliance functions are set at the factory so that your appliance is fully functional.

Before you alter, activate or deactivate the device functions, make sure that the following requirements are met:

- ❑ You have read and understood the descriptions of how the display works. (see 3 Functionality of the Touch display)
- ❑ You have familiarised yourself with the operating and display elements of your appliance.



Switching the appliance off and on

Use this function to switch the entire appliance off and on.

Switching off the appliance

When you switch the appliance off, then the previously saved settings are saved.

Make sure that the following requirements are fulfilled:

- ❑ Handling instructions (see 11 Shutting down) are carried out.



Fig. 7

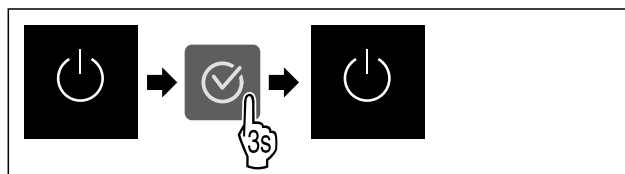

Fig. 8

- ▶ Carry out action steps according to the illustration.
- ▷ Appliance is switched off.
- ▷ The standby symbol appears in the display.
- ▷ Display turns black.

Switching on the appliance

If the display is in sleep mode:

- ▶ Press any navigation key.

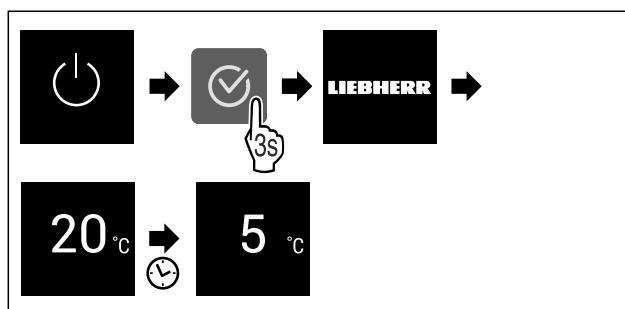

Fig. 9 Example illustration

- ▶ Carry out action steps according to the illustration. When the appliance starts in demo mode:
- ▶ Deactivating demo mode. (see Deactivating demo mode)
- ▷ The appliance is switched on.
- ▷ Previous settings are restored.
- ▷ The appliance cools to the target temperature set.



WiFi

Use this function to connect your appliance to WiFi. You can then operate it via the SmartDevice app on a mobile device. You can also use this function to disconnect or reset the WiFi connection.

To connect your device to WiFi, you need the SmartDeviceBox.*

Controls

More information on the SmartDevice: (see 1.3 SmartDevice)

Note

The SmartDevice function is not available in the following countries: Russia, Belarus, Kazakhstan.
You cannot use the SmartDeviceBox.*

Establishing the WiFi connection for the first time

Make sure that the following requirements are fulfilled:

- You have purchased and inserted a SmartDeviceBox. (see 1.3 SmartDevice) *
- You have installed the SmartDevice app (see apps.home.liebherr.com).
- Registration in the SmartDevice app is completed.



Fig. 10

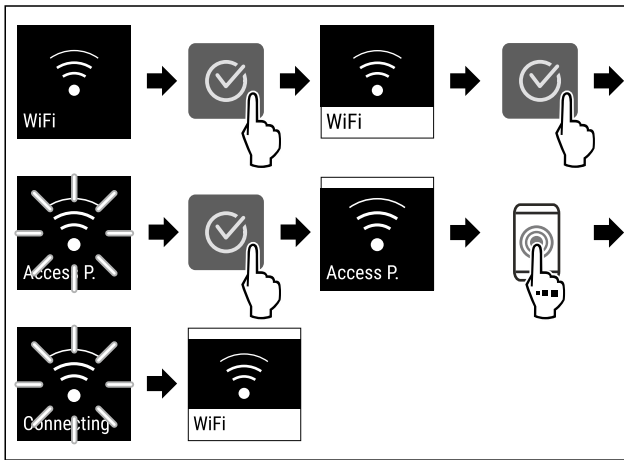

Fig. 11

- ▶ Carry out action steps according to the illustration.
- ▷ Connection is established.

Disconnecting from the WiFi

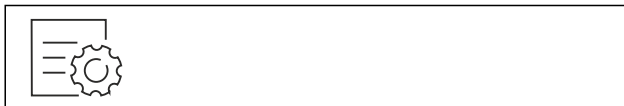

Fig. 12

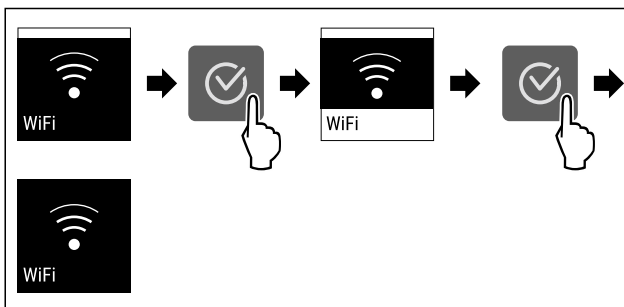

Fig. 13

- ▶ Carry out action steps according to the illustration.
- ▷ There is no connection.

Resetting the WiFi connection



Fig. 14

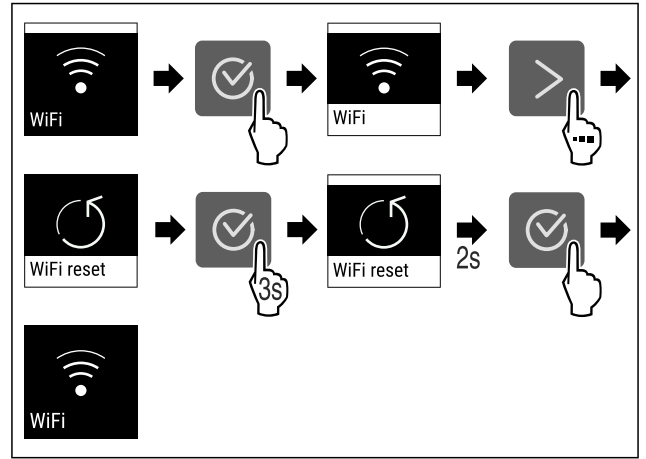

Fig. 15

- ▶ Carry out action steps according to the illustration.
- ▷ WiFi connection and other WiFi settings are reset to factory settings.

Showing information about the WiFi connection



Fig. 16

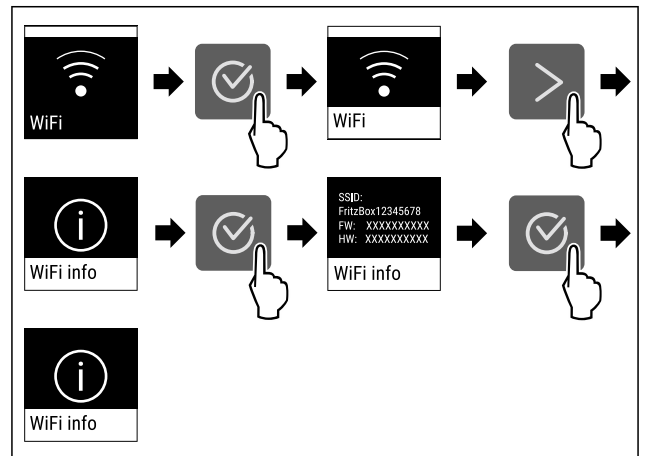

Fig. 17

- ▶ Carry out action steps according to the illustration.

5 °C Temperature

Use this function to set the temperature.

The temperature depends on the following factors:

- Frequency of door opening
- Duration of door opening
- Room temperature of the installation site
- Type, temperature and quantity of food

Temperature zone	Factory-set temperature	Recommended setting
5 °C Fridge section	5 °C	4 °C

Setting the temperature

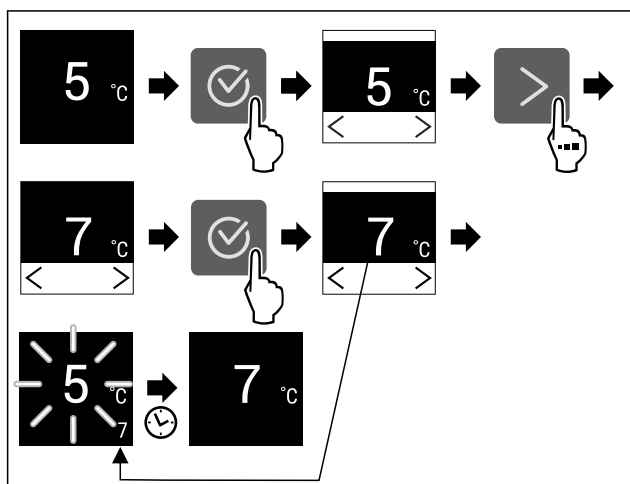

Fig. 18 Example illustration

- ▶ Carry out action steps according to the illustration.
- ▷ Temperature is set.

Temperature unit

Use this function to set the temperature unit. You can set degrees Celsius or degrees Fahrenheit as the temperature unit.

Setting the temperature unit



Fig. 19

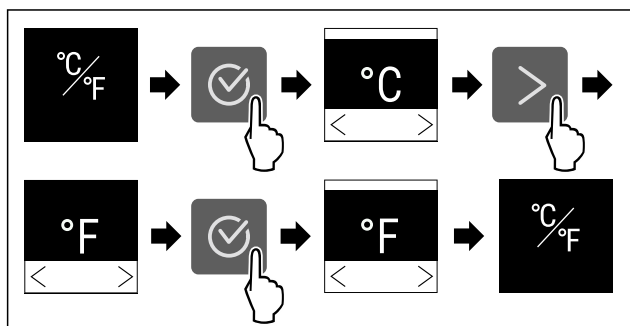

Fig. 20 Example illustration: Switch from degrees Celsius to degrees Fahrenheit.

- ▶ Carry out action steps according to the illustration.
- ▷ The temperature unit is set.

C5 C-Value*

Use this function to set the C-Value. You can use the C-Value to make the **** freezer compartment slightly warmer or colder. The C-Value is pre-set to value C5 as delivered.

Value	Description
C1 to C4	**** freezer compartment gets colder.
C5	Pre-set value
C6 to C9	**** freezer compartment gets warmer.

Setting the C-Value



Fig. 21

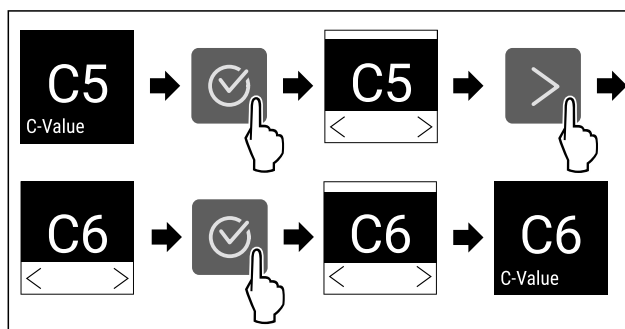

Fig. 22 Example illustration: Switch from C5 to C6.

- ▶ Carry out action steps according to the illustration.
- ▷ The C-Value is set.

SuperCool

You can use this function to activate or deactivate SuperCool. If SuperCool is activated, then the appliance increases the cooling capacity. It allows you to achieve lower cooling temperatures. You can activate SuperCool when you would like to cool a large quantity of food quickly.

If SuperCool is activated, then lower temperatures are reached in the **** freezer compartment. You can activate SuperCool when you would like to freeze food in the **** freezer compartment.*

If the function is active, the appliance operates at higher power. As a result, the appliance's operating noise may be temporarily louder and energy consumption will increase.

Activating SuperCool

Time for activation of the function:

- When you would like to store fresh food in the fridge section: Activate the function when inserting food.
- When you would like to store fresh food in the **** freezer compartment: Activate the function when inserting food.*



Fig. 23

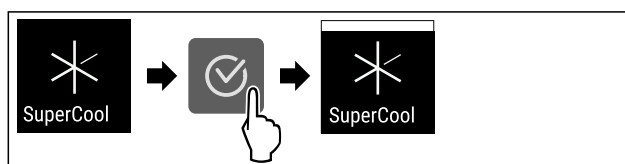

Fig. 24

- ▶ Carry out action steps according to the illustration.
- or-
- ▶ Activate with the SmartDevice app.*
- ▷ SuperCool is activated.

Deactivating SuperCool

SuperCool is deactivated automatically after 18 hours. However, you can also deactivate SuperCool manually at any time:

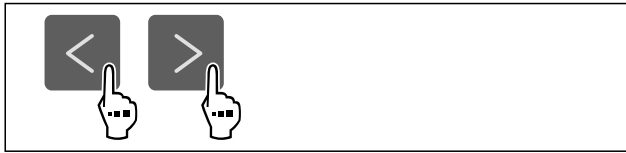

Fig. 25

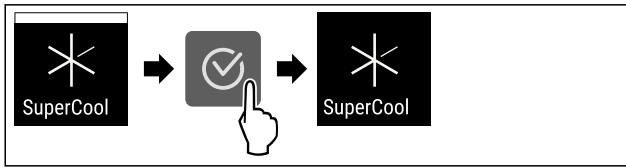

Fig. 26

► Carry out action steps according to the illustration.

-or-

► Deactivate with the SmartDevice app.*

▷ SuperCool is deactivated.

▷ The appliance continues to run in normal mode.

▷ The appliance cools to the temperature set previously.



PowerCool *

You can use this function to activate or deactivate PowerCool. PowerCool ensures optimised temperature layers for cooling your food.

The function applies to the fridge section.

Application:

- At higher room temperatures (as of approx. 35 °C)
- At high humidity, e.g. on summer days
- When storing moist food, in order to prevent condensate forming in the interior

Note

The fan may also run even if the function is deactivated. It therefore ensures even temperature distribution in the appliance.

If the function is active, the device operates at higher power. As a result, the device's operating noise may be temporarily louder and energy consumption will increase.

Activating PowerCool

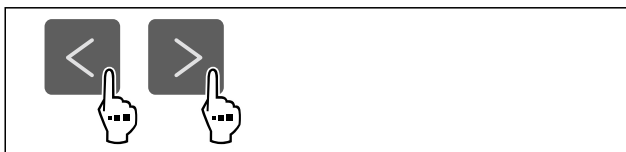

Fig. 27

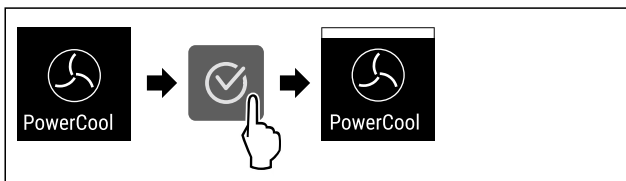

Fig. 28

► Carry out action steps according to the illustration.

▷ PowerCool is activated.

Deactivating PowerCool

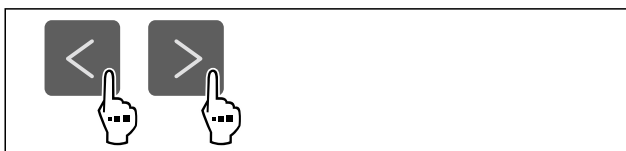

Fig. 29

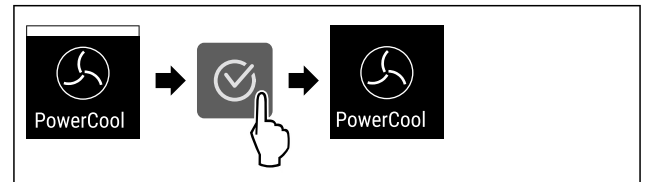

Fig. 30

► Carry out action steps according to the illustration.

▷ PowerCool is deactivated.



PartyMode

You can use this function to activate or deactivate PartyMode. PartyMode activates various functions that are useful for a party.

PartyMode activates the following functions:

- SuperCool (see SuperCool)

You can adjust all listed functions individually and flexibly. When you deactivate PartyMode, all changes are discarded.

If the function is active, the device operates at higher power. As a result, the device's operating noise may be temporarily louder and energy consumption will increase.

Activating PartyMode

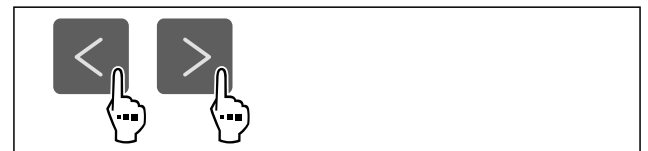

Fig. 31

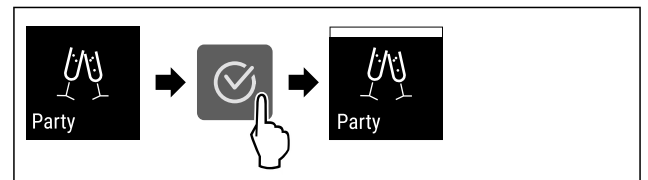

Fig. 32

► Carry out action steps according to the illustration.

▷ PartyMode and the associated functions are activated.

▷ The current temperature flashes until the target temperature is reached.

Deactivating PartyMode

The PartyMode is automatically deactivated after 24 seconds. However, you can also deactivate PartyMode manually at any time:

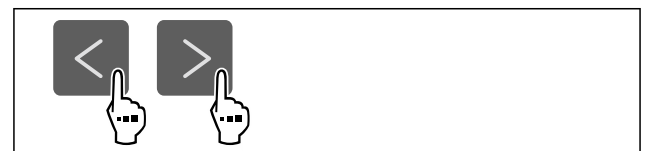

Fig. 33

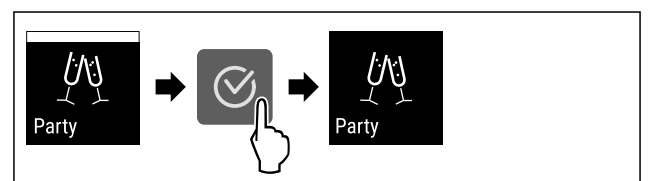

Fig. 34

► Carry out action steps according to the illustration.

▷ PartyMode is deactivated.

- ▷ The appliance cools to the temperature set previously: The current temperature flashes until the target temperature is reached.

HolidayMode

You can use this function to activate or deactivate HolidayMode. If you activate HolidayMode, the fridge section is set to 15 °C. This saves you energy during longer periods of absence and prevents bad odours and growth of mould.

Appliance status when HolidayMode is active
Fridge section cools to 15 °C.
EasyFresh cools to 15 °C.
The set temperature is maintained in the **** freezer compartment.*
PartyMode is deactivated.
SuperCool is deactivated.
PowerCool is deactivated.*

Activating HolidayMode

- ▶ Empty the fridge section completely.
- ▶ Empty EasyFresh completely.

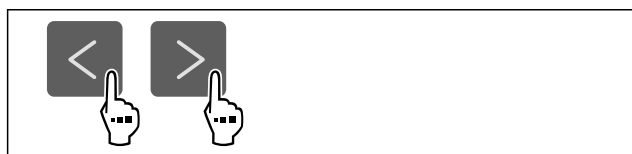

Fig. 35

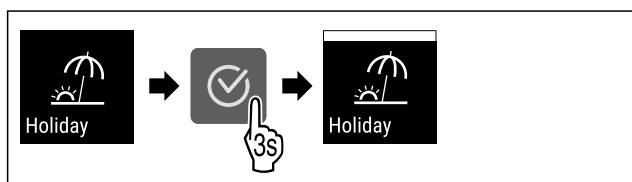

Fig. 36

- ▶ Carry out action steps according to the illustration.
- ▷ HolidayMode is activated.
- ▷ Temperature display shows HolidayMode symbol.

Deactivating HolidayMode

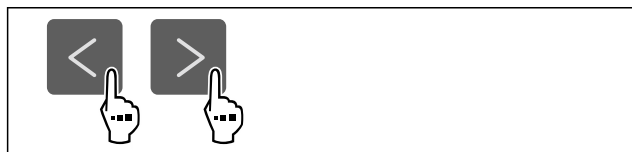

Fig. 37

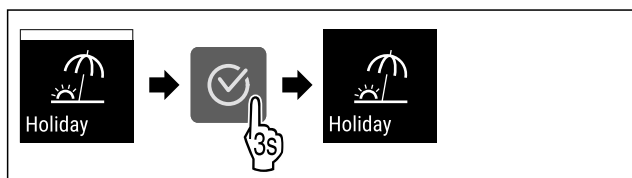

Fig. 38

- ▶ Carry out action steps according to the illustration.
- ▷ HolidayMode is deactivated.
- ▷ The appliance cools to the temperature set previously.

SabbathMode

You can use this function to activate or deactivate SabbathMode. If you activate this function, some electronic functions are switched off. As a result, your device meets the religious requirements for Jewish holidays such as Sabbath and complies with STAR-K Kosher certification.

Device status when SabbathMode is active
The status display shows SabbathMode permanently.
All functions on the display are locked except for the Deactivate SabbathMode function .
Active functions remain active.
The display remains bright when you close the door.
The interior lighting is deactivated.
Reminders are not implemented. The set time interval stops.
Reminders and warnings are not displayed.
There is no door alarm.
There is no temperature alarm.
The defrosting cycle operates only for the specified time, without considering the appliance consumption.
After a power failure, the appliance returns to SabbathMode.

Device status

Note

This appliance has certification from the "Institute for Science and Halacha". (www.machonhalacha.co.il)

You can find a list of STAR-K-certified appliances at www.star-k.org/appliances.

Activating SabbathMode

WARNING

Danger of food poisoning from spoiled food!
If you have SabbathMode activated and a power failure occurs, no message appears in the status display about the power failure. Once the power is restored, the appliance continues to operate in SabbathMode. The power failure may mean that food spoils and the consumption of this food could lead to food poisoning.

After a power failure:

- ▶ Do not consume food that was frozen and has thawed out.



Fig. 39

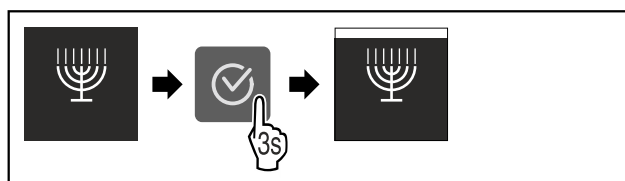

Fig. 40

- ▶ Carry out action steps according to the illustration.
- ▷ SabbathMode is activated.
- ▷ The status display shows SabbathMode permanently.

Controls

Deactivating SabbathMode

The SabbathMode is automatically deactivated after 80 hours. However, you can also deactivate SabbathMode manually at any time:

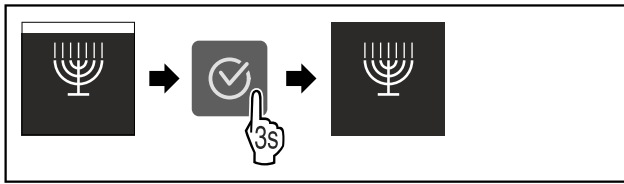

Fig. 41

- ▶ Carry out action steps according to the illustration.
- ▷ SabbathMode is deactivated.



E-Saver

You can use this function to activate or deactivate Energy saving mode. If energy saving mode is activated, the energy consumption decreases and the temperature in the device increases. The food remains fresh, but the shelf life is shortened.

Temperature zone	Recommended setting (see Setting the temperature)	Temperature with active E-Saver
5 °C Fridge section	4 °C	7 °C

Temperatures

Activating E-Saver

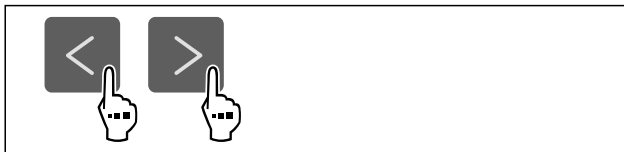

Fig. 42

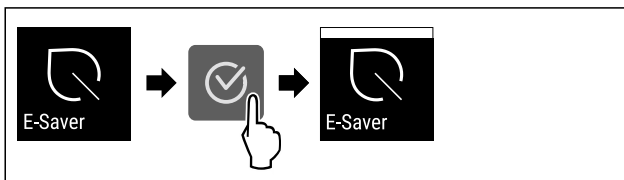

Fig. 43

- ▶ Carry out action steps according to the illustration.
- ▷ Energy saving mode is activated.

Deactivating E-Saver

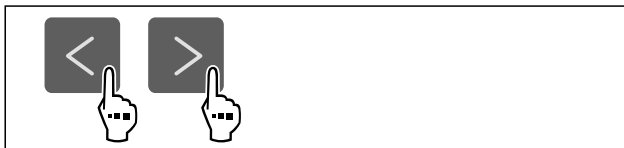

Fig. 44

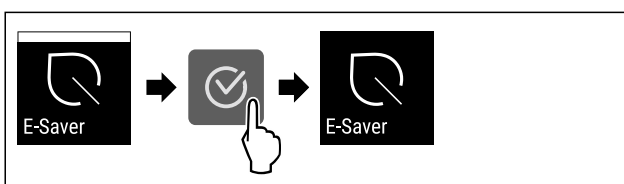

Fig. 45

- ▶ Carry out action steps according to the illustration.
- ▷ Energy saving mode is deactivated.



CleaningMode

You can use this function to activate or deactivate CleaningMode. CleaningMode enables the appliance to be cleaned conveniently.

This setting applies to the fridge section.

Application:

- Clean the fridge section. (see 9.5 Cleaning the appliance)

Device status when CleaningMode is active
The status display shows CleaningMode permanently.
The fridge section is switched off.
Interior lighting is activated.
The reminders and warnings are not displayed. No signal tone sounds.

Device status

Activating CleaningMode



Fig. 46

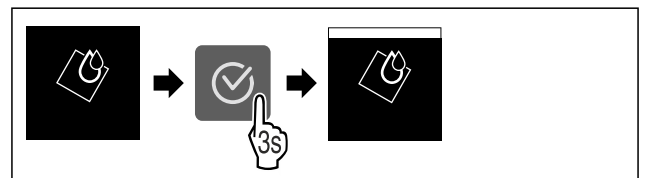

Fig. 47

- ▶ Carry out action steps according to the illustration.
- ▷ CleaningMode is activated.
- ▷ The status display shows CleaningMode permanently.

Deactivating CleaningMode

CleaningMode is deactivated automatically after 60 minutes. However, you can also deactivate CleaningMode manually at any time:

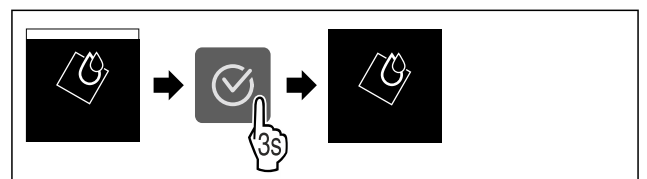

Fig. 48

- ▶ Carry out action steps according to the illustration.
- ▷ CleaningMode is deactivated.
- ▷ The appliance cools to the temperature set previously.



Display brightness

Use this function to set the display brightness in stages.

You can select the following brightness levels:

- 40 %
- 60 %
- 80 %
- 100 % (pre-setting)

Setting the brightness

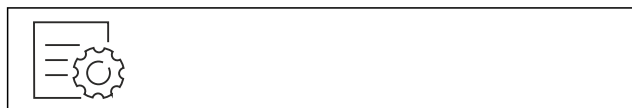

Fig. 49

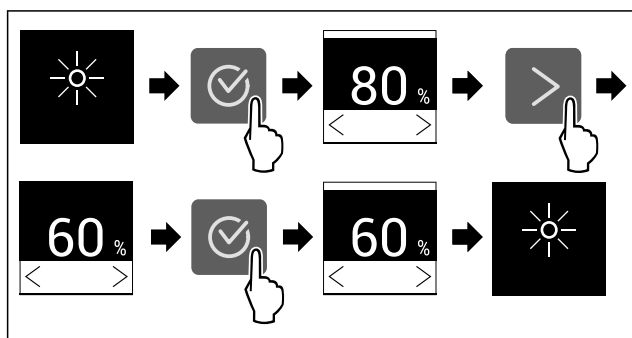

Fig. 50 Example illustration: Switch from 80 % to 60 %.

- ▶ Carry out action steps according to the illustration.
- ▷ The brightness is set.

Door alarm

Use this function to activate or deactivate the door alarm. The door alarm sounds if the door is open for too long. The door alarm is activated on delivery. You can set how long the door may be open before the door alarm sounds.

The following values can be set:

- 1 minute
- 2 minutes
- 3 minutes
- Off

Setting the door alarm

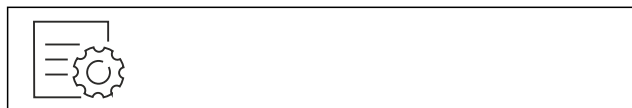

Fig. 51

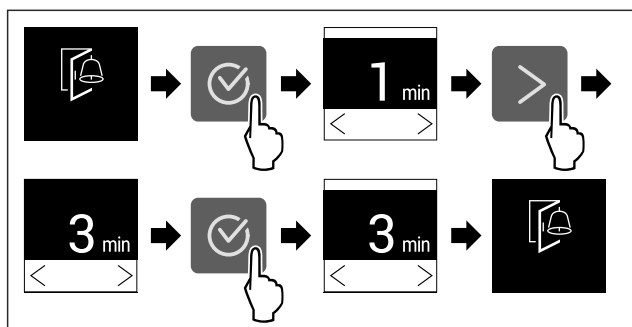

Fig. 52 Example illustration: Change door alarm from 1 minute to 3 minutes.

- ▶ Carry out action steps according to the illustration.
- ▷ The door alarm is set.

Deactivating the door alarm



Fig. 54

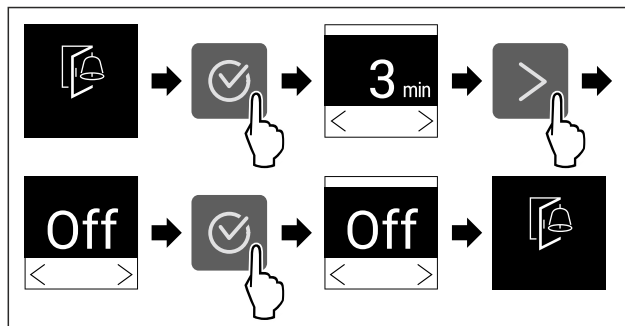

Fig. 55

- ▶ Carry out action steps according to the illustration.
- ▷ The door alarm is deactivated.

Input lock

You can use this function to activate or deactivate the input lock. The input lock prevents the appliance being operated accidentally, e.g. by children.

Application:

- Avoid unintentional modification of functions.
- Avoid unintentional switching off of the device.
- Avoid unintentional temperature setting.

Activating the input lock

If you activate the input lock, you can continue to navigate in the menus but you cannot select or change other functions.



Fig. 56

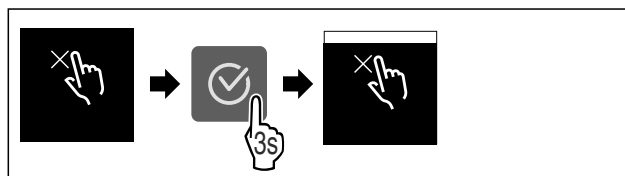

Fig. 57

- ▶ Carry out action steps according to the illustration.
- ▷ Input lock is activated.

Deactivating the input lock

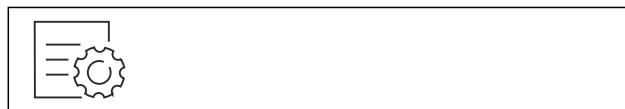

Fig. 58

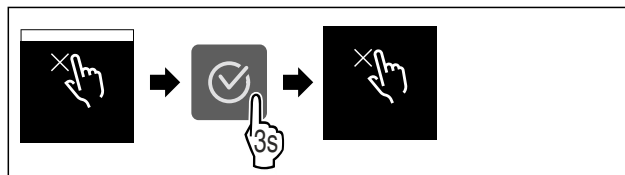

Fig. 59

- ▶ Carry out action steps according to the illustration.
- ▷ Input lock is deactivated.

Controls



Device information

Use this function to indicate the model name, index, serial number and service number of your device. You will need the device information when you contact customer service. (see 10.4 Customer Service)

This function also opens the Advanced menu. (see 3 Functionality of the Touch display)

Indicating the device information



Fig. 60



Fig. 61

- ▶ Carry out action steps according to the illustration.
- ▷ Display indicates device information.



Software

Use this function to indicate the software version of your device.

Indicating the software version



Fig. 62



Fig. 63

- ▶ Carry out action steps according to the illustration.
- ▷ Display indicates software version.



Reminder*

Use this function to activate or deactivate the reminders. The function is activated on delivery.

If the function is activated, the following reminders will appear:

- Replace the FreshAir activated carbon filter (see Replace the FreshAir activated carbon filter) *

Activating the reminder

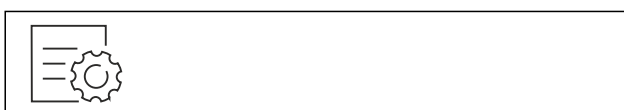

Fig. 64

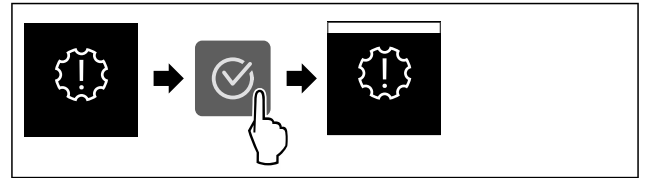

Fig. 65

- ▶ Carry out action steps according to the illustration.
- ▷ Reminder is activated.

Deactivating the reminder



Fig. 66

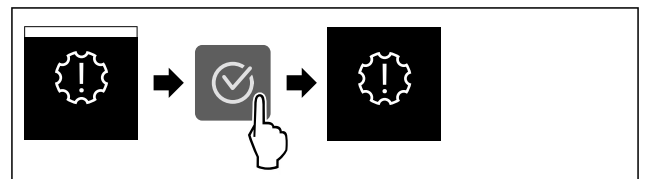

Fig. 67

- ▶ Carry out action steps according to the illustration.
- ▷ Reminder is deactivated.



Demo mode

Demo mode is a special feature for dealers who want to demonstrate appliance features. If you activate demo mode, all refrigeration functions are deactivated.

If you switch on your appliance and “Demo” appears in the status display, then demo mode is already activated.

If you activate and then deactivate demo mode, the appliance will be reset to factory defaults. (see Resetting to factory settings)

Activating demo mode

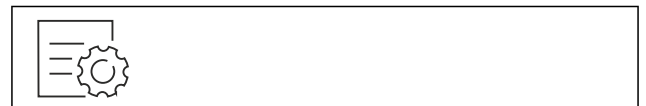

Fig. 68

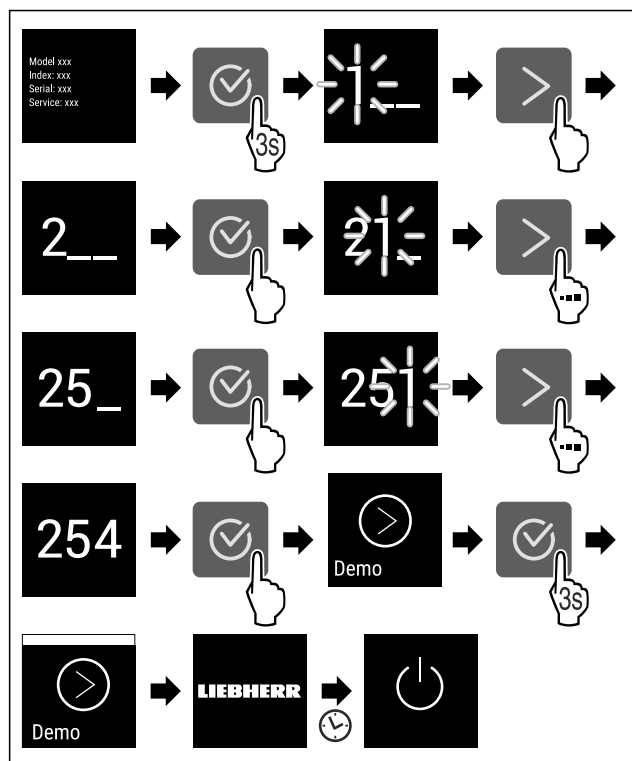

Fig. 69

- ▶ Carry out action steps according to the illustration.
- ▷ Demo mode is activated.
- ▷ Appliance is switched off.
- ▶ Switch on the appliance. (see 4.1 Switching on appliance (first use))
- ▷ "DEMO" appears in the status display.

Deactivating demo mode



Fig. 70

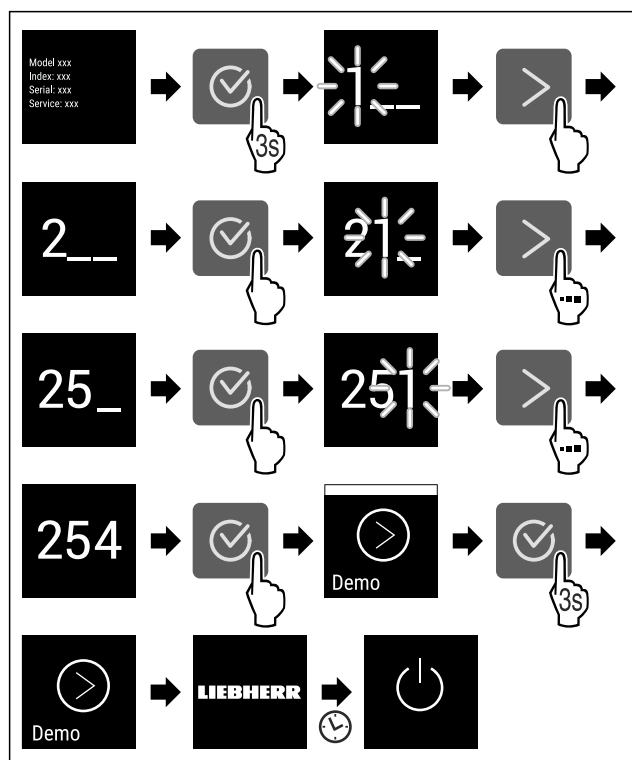

Fig. 71

- ▶ Carry out action steps according to the illustration.
- ▷ Demo mode is deactivated.
- ▷ Appliance is switched off.
- ▶ Switch on the appliance. (see 4.1 Switching on appliance (first use))
- ▷ Appliance is reset to factory settings.



Resetting to factory settings

Use this function to reset all settings to factory defaults. All settings you have made so far are reset to their original settings.

Performing a reset



Fig. 72

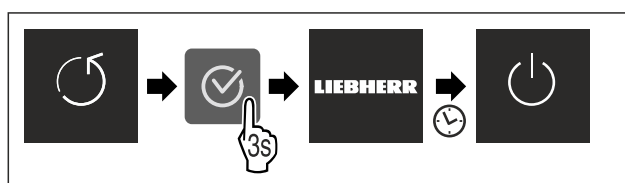

Fig. 73

- ▶ Carry out action steps according to the illustration.
- ▷ Device is reset.
- ▷ Device is switched off.
- ▶ Restart the device. (see 4.1 Switching on appliance (first use))

7.3 Messages

There are two categories of messages:

Category	Importance
Warning	Warnings appear in the event of a door alarm or malfunction. Simple warnings can be cancelled by yourself. In the event of serious malfunctions, you must contact customer service. (see 10.4 Customer Service)
Reminder	Reminders remind you of general processes. You can carry out these operations to end the message.



7.3.1 Overview of warnings

Behaviour of the appliance in the event of warnings:

- Warning appears on the display.
- The alarm tone sounds at an ever-increasing volume.
- The interior lighting pulsates for some warnings.

Message	Cause	Exit the message
 Door alarm	The message appears if the door is open for too long.	Carry out action steps (see Door alarm).

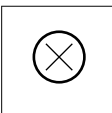
Features

Message	Cause	Exit the message
 Error	The message appears if there is an appliance error. A component of the appliance has a fault.	Carry out action steps (see Error).
 WiFi Error* WLAN error*	The message appears if the appliance could not be connected to the WLAN. (see Establishing the WiFi connection for the first time)*	Carry out action steps (see WLAN error)*.

7.3.2 Ending warnings

Door alarm

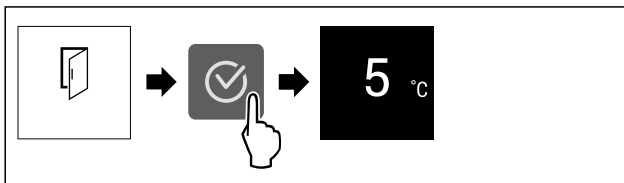

Fig. 74 Example illustration

- ▶ Carry out action steps according to the illustration.

-or-

- ▶ Close the door.

- ▷ The display returns to the status indicator.

You can set how long the door may be open before the door alarm sounds. (see Setting the door alarm)

Error

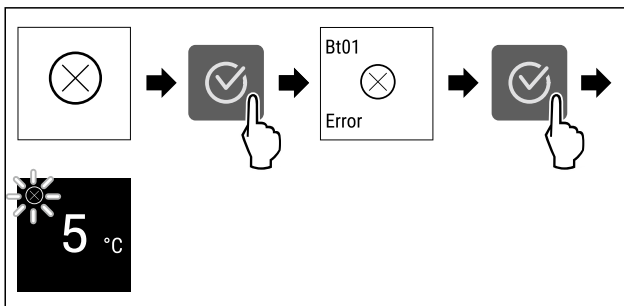

Fig. 75 Example illustration

- ▶ Press the confirmation symbol.
- ▷ Error code is displayed.
- ▶ Note the error code.
- ▶ Press the confirmation symbol.
- ▷ The display returns to the status indicator.
- ▶ Contact Customer Service. (see 10.4 Customer Service)

WLAN error*

- ▶ Check WLAN connection.
- ▶ Reconnect the appliance to the WLAN. (see WiFi)

7.3.3 Overview of reminders

Behaviour of the appliance during reminders:

- Reminder appears on the display.
- Alarm tone sounds.
- The interior lighting pulsates for some reminders.

Message	Cause	Exit the message
 FreshAir* Replace the FreshAir activated carbon filter*	The message appears when the activated carbon filter needs to be replaced.*	Carry out action steps (see Replace the FreshAir activated carbon filter)*.

7.3.4 Ending reminders

Replace the FreshAir activated carbon filter

Liebherr recommends: Replace the FreshAir activated carbon filter every 6 months.

Note

FreshAir activated charcoal filters can be purchased from the Liebherr-Hausgeräte store at home.liebherr.com/shop/de/deu/zubehor.html.

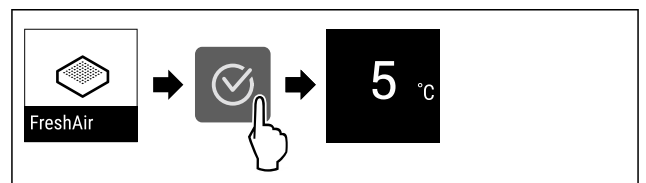

Fig. 76 Example illustration*

- ▶ Press the confirmation symbol.
- ▶ Replace the activated carbon filter. (see 9.1 FreshAir carbon filter*)
- ▷ Activated carbon filter ensures optimum air quality in the cooling unit.
- ▷ Reminder appears again after 6 months.

If you no longer wish to receive this reminder, you can deactivate it. (see Deactivating the reminder)

8 Features

8.1 4-star freezer compartment*

8.1.1 Opening/closing the freezer compartment

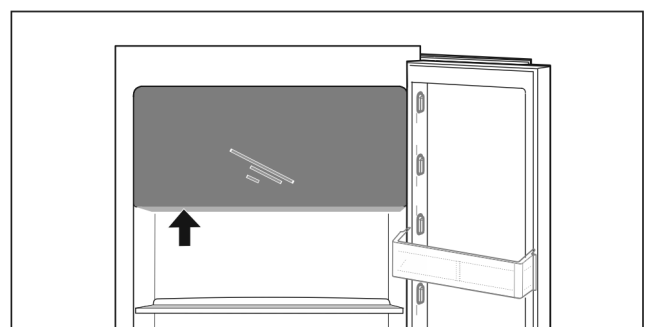
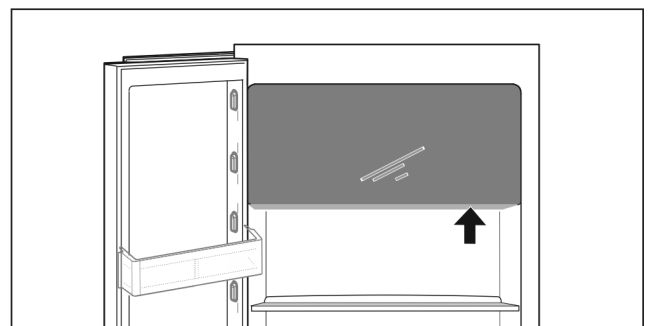

Fig. 77

Opening the freezer compartment:

- ▶ Reach into the handle area from below.
- ▶ Push the handle plate while pulling the door towards you.

Closing the freezer compartment:

- ▶ Close the door while pushing from the front.
- ▷ Door is engaged.

8.2 Door rack

8.2.1 Move/remove the door rack

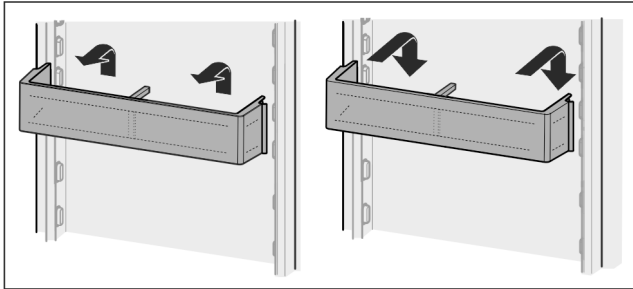

Fig. 78

- ▶ Slide the rack upwards.
- ▶ Pull forwards.
- ▶ Re-insert it in reverse order.

8.2.2 Disassembling the door rack

The door rack can be taken apart for cleaning.

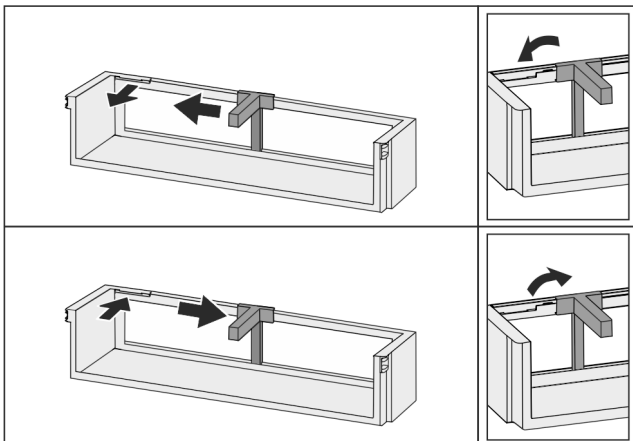

Fig. 79

- ▶ Disassemble the door rack.

8.3 Shelves

8.3.1 Adjusting/removing the shelves

The shelves are prevented from being pulled out accidentally by pull out stops.

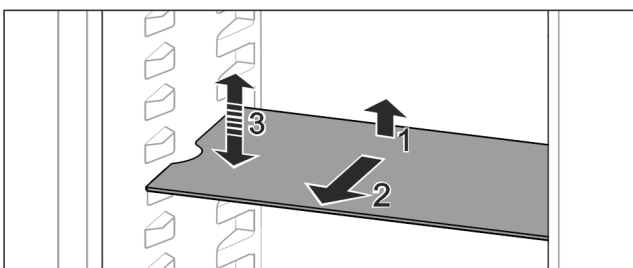

Fig. 80

- ▶ Lift the shelf and pull forward.
- ▷ Line up the side runner.

- ▶ Adjust the height of the shelf: Lift or lower it to the desired height and slide it in.

-or-

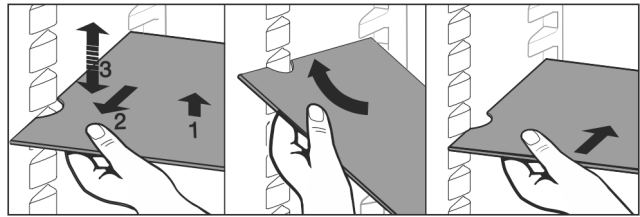

Fig. 81

- ▶ Remove the shelf completely: Pull it out to the front.

- ▶ Easier removal: Set the shelf at an angle.
- ▶ Insert the shelf again: Slide it in all the way.
- ▷ The pull-out stoppers point downwards.
- ▷ The pull-out stoppers are behind the front support.

You can also remove the shelf above the EasyFresh compartments.

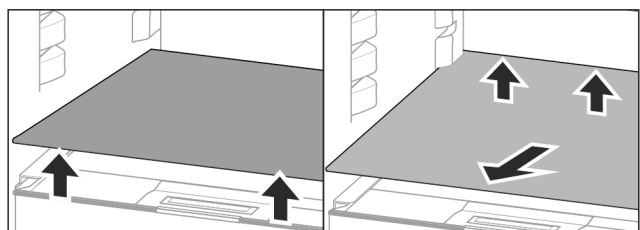

Fig. 82

Removing the shelf:

- ▶ Lift the shelf at the front and back.
- ▶ Pull it out towards you.

Do not store any goods on the compartment cover below!

Inserting the shelf:

- ▶ Place the shelf at an angle, sloping down towards the back.
- ▷ The pull-out stoppers point downwards.
- ▶ Slide the shelf into place.

8.3.2 Dismantling the shelves

The shelves can be dismantled for cleaning.

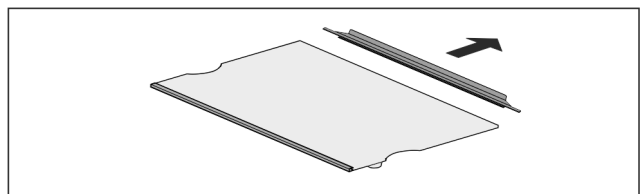

Fig. 83

- ▶ Dismantling the shelf.

8.4 Dividing shelf*

8.4.1 Using the dividing shelf

The shelves are prevented from being pulled out accidentally by pull out stops.

Features

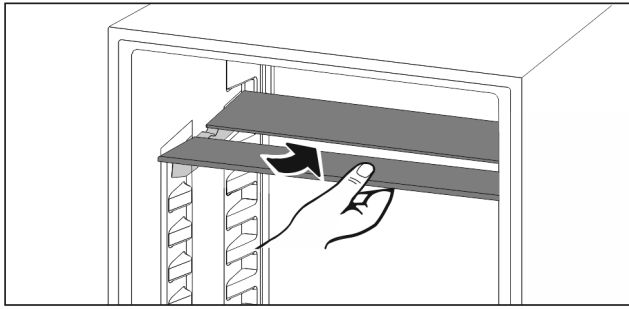

Fig. 84

- ▶ Push the dividing shelf underneath as shown.

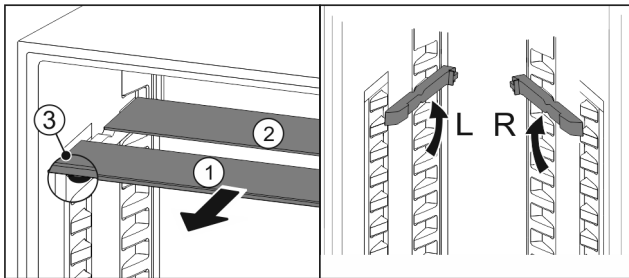

Fig. 85

Adjusting the height:

- ▶ Pull the glass panels out Fig. 85 (1) from the front, one at a time.
- ▶ Release the support rails and click in at the height you want.
- ▶ Slide in the glass panels one at a time.
- ▷ Flat pull-out stoppers at the front, right behind the support rails.
- ▷ High pull-out stoppers at the back.

Using both shelves:

- ▶ Hold the glass panel with one hand and pull it to the front.
- ▷ The glass panel Fig. 85 (1) and trim strip are at the front.
- ▷ The stops Fig. 85 (3) point down.
- Appliances with freezer compartment:*
- ▶ Do not place the support rails and dividing shelf in front of the fan.*

8.5 VarioSafe *

The VarioSafe offers space in the refrigerator compartment for small groceries, packages, tubes and jars, for example.

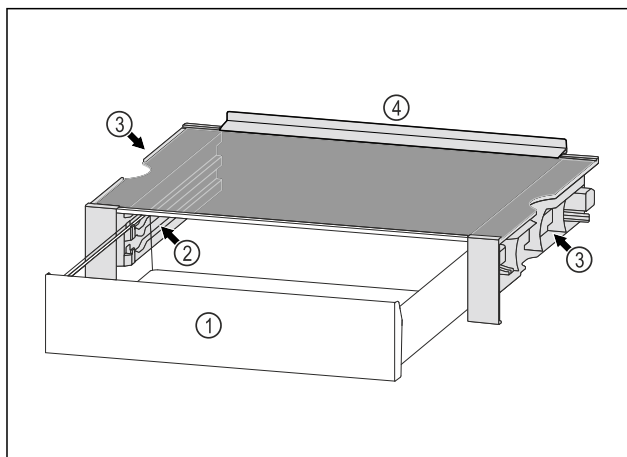

Fig. 86

- (1) VarioSafe drawer
- (2) Side panels with ribs for VarioSafe drawer
- (3) Recesses on the left and right side panel
- (4) Stop edge

8.5.1 Inserting the VarioSafe

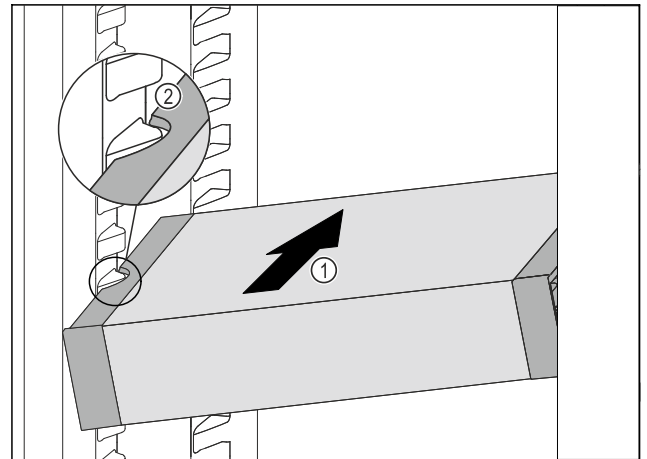

Fig. 87

- ▶ Insert the VarioSafe into the fridge section at an angle Fig. 87 (1) until the recesses in the side Fig. 87 (2) of the VarioSafe are at the level of the support rib in the fridge section.

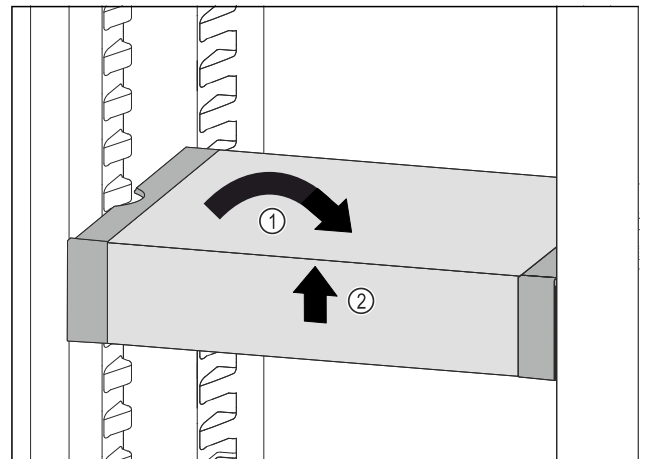

Fig. 88

- ▶ Set VarioSafe straight. Fig. 88 (1)
- ▶ Lift VarioSafe at the front. Fig. 88 (2)

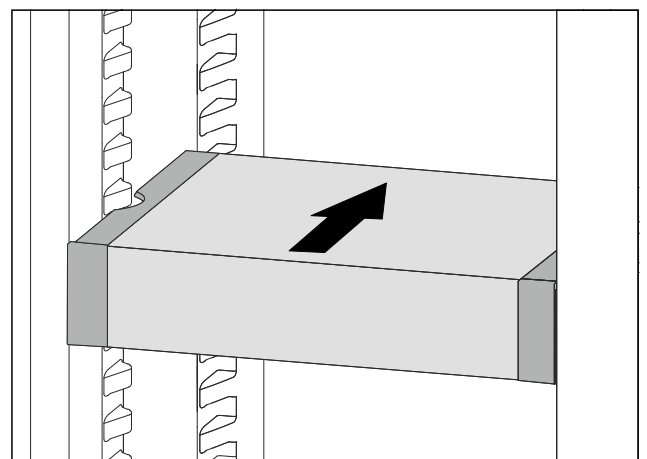

Fig. 89

- ▶ Lift VarioSafe up toward the front.
- ▶ Push VarioSafe in to the rear.
- ▶ Lower VarioSafe.
- ▷ VarioSafe audibly engages.
- ▷ VarioSafe is inserted.

8.5.2 Repositioning the VarioSafe

You can move the VarioSafe as a whole in the refrigerator compartment.

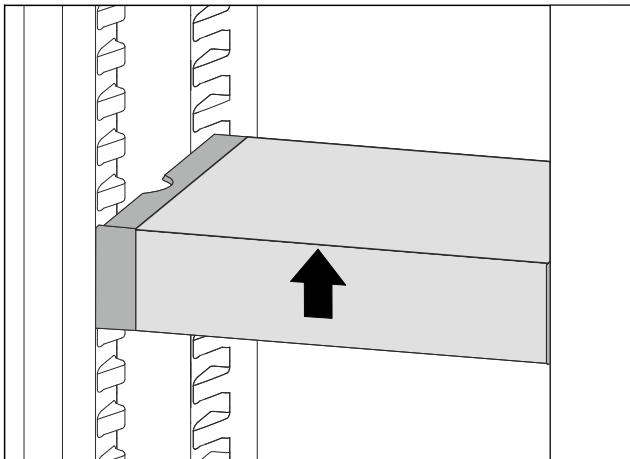

Fig. 90

- ▶ Lift VarioSafe at the front.

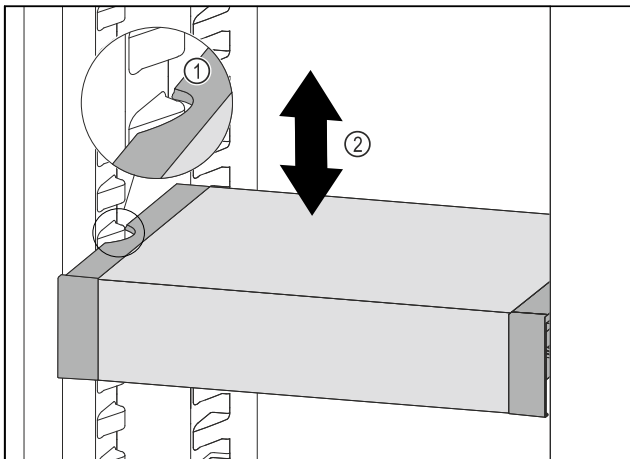

Fig. 91

- ▶ Pull VarioSafe forwards until the recesses in the side of the VarioSafe are at the level of the support rib in the refrigerator compartment. Fig. 91 (1)
- ▶ Move VarioSafe up or down in the refrigerator compartment until the desired height is reached. Fig. 91 (2)

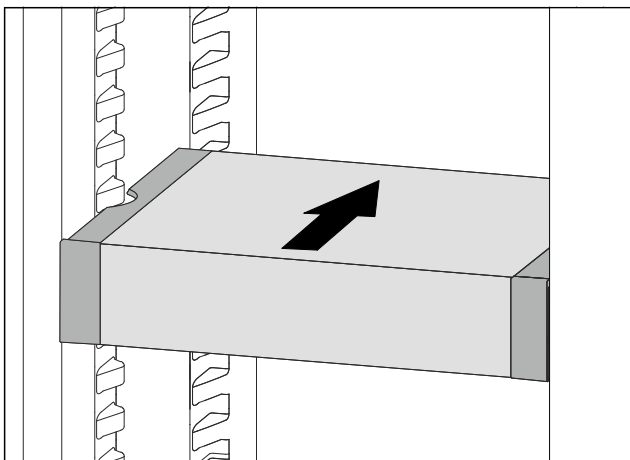

Fig. 92

- ▶ Lift VarioSafe at the front.
- ▶ Push VarioSafe in to the rear.
- ▷ VarioSafe audibly engages.
- ▷ VarioSafe is offset in height.

8.5.3 Moving the VarioSafe drawer

You can use the VarioSafe drawer at two different heights. If you would like to store taller foodstuffs in the VarioSafe drawer, slide the VarioSafe drawer in on the bottom rib. If you would like to store smaller foodstuffs in the VarioSafe drawer, slide the VarioSafe drawer in on the top rib.

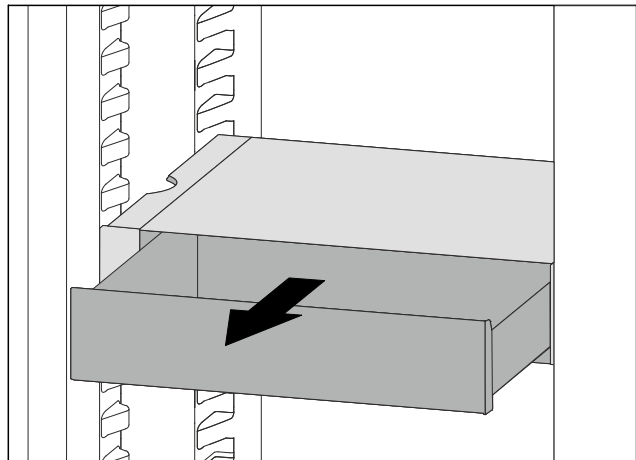

Fig. 93

- ▶ Pull out the VarioSafe drawer as far as it will go.
- ▶ Lift the VarioSafe drawer up at the front.
- ▶ Remove the VarioSafe drawer to the front.

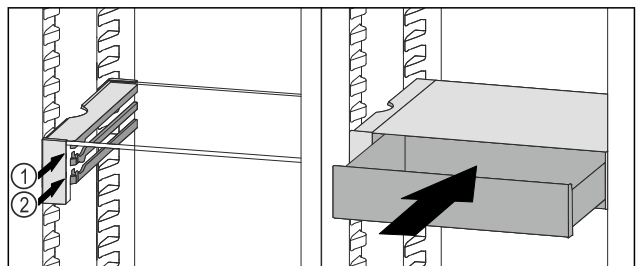

Fig. 94

- ▶ Lift the VarioSafe drawer up at the front.
- ▶ Place the VarioSafe drawer behind the stoppers on desired rib Fig. 94 (1) or Fig. 94 (2).
- ▷ VarioSafe drawer is offset in height.

8.5.4 Removing the VarioSafe

You can remove the VarioSafe as a whole.

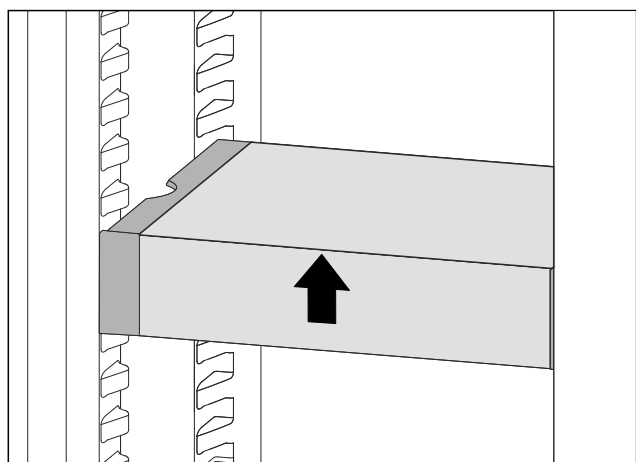

Fig. 95

- ▶ Lift VarioSafe at the front.

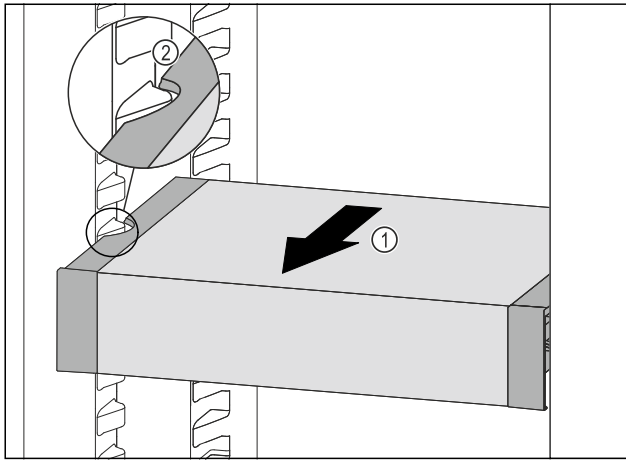

Fig. 96

- ▶ Pull VarioSafe forwards Fig. 96 (1) until the recesses in the side of the VarioSafe are at the level of the support rib in the fridge section. Fig. 96 (2)

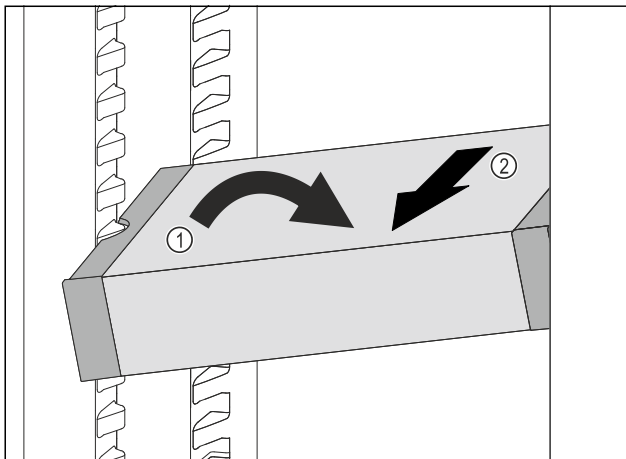

Fig. 97

- ▶ Set VarioSafe in refrigerator compartment at an angle. Fig. 97 (1)
- ▶ Take VarioSafe out to the front. Fig. 97 (2)
- ▷ VarioSafe is removed.

8.5.5 Disassembling the VarioSafe

You can disassemble the VarioSafe into its individual parts if you want to clean the VarioSafe or if you need to install or remove parts.

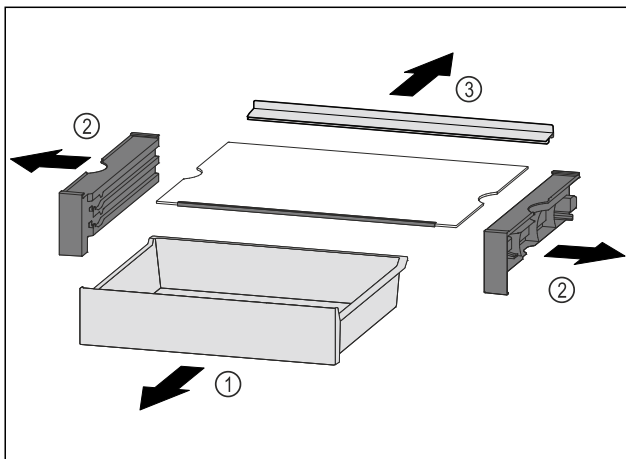

Fig. 98

- ▶ Remove VarioSafe as a whole. (see 8.5.4 Removing the VarioSafe)
- ▶ Disassemble VarioSafe according to the illustration.

8.6 Space for baking tray*

There is space for a baking tray Fig. 1 (8) above the drawers.

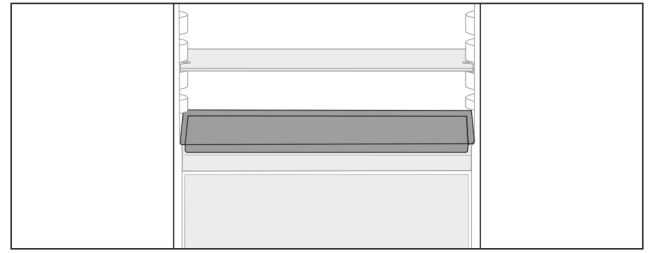

Fig. 99

Ensure that the following conditions are met:

- Max. baking tray dimensions are adhered to (see 10.1 Technical specifications) .
- Baking tray is cooled to room temperature.
- The lowest door rack is set at least one position higher.

With the door open to 90°:

- ▶ Slide the baking tray onto the lower side runners.

8.7 Drawers

You can remove the drawers for cleaning.

The way to remove/insert the drawers varies depending on the pull-out system. Your appliance can contain various pull-out systems.

Note

The energy consumption increases and the cooling power goes down if ventilation is not sufficient.

- ▶ Always leave the fan air vents clear on the back wall!

8.7.1 Drawer on appliance base or glass shelf

The drawer runs directly on the appliance base or on a glass shelf. There are no rails.

When you remove the drawers, you can use the glass shelves below them as storage shelves.*

Removing drawer

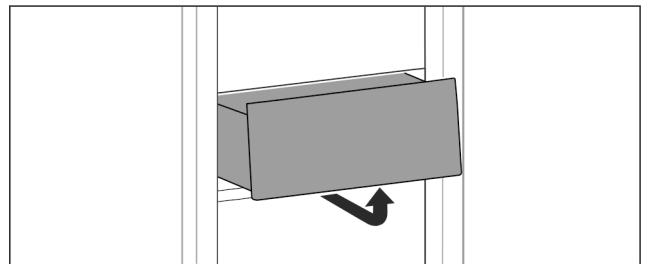

Fig. 100

- ▶ Remove drawer as shown in the illustration.

Inserting drawer

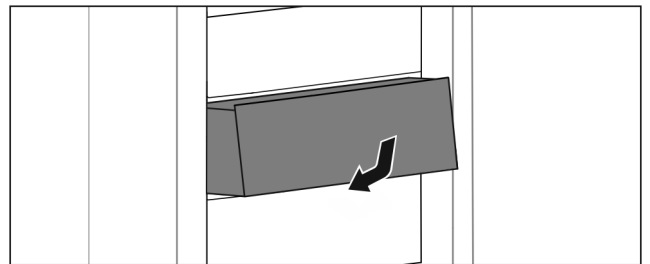

Fig. 101

- ▶ Insert drawer as shown in the illustration.

8.7.2 Drawer on rails

Removing drawer

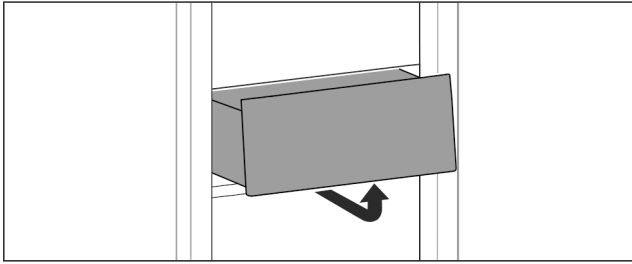

Fig. 102

- ▶ Remove drawer as shown in the illustration.

Inserting drawer

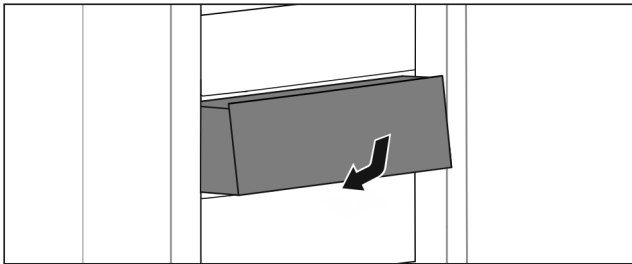

Fig. 103

- ▶ Insert drawer as shown in the illustration.

8.7.3 Drawer on telescopic rails

The drawer runs on extendible rails (telescopic rails). There are fully extendible telescopic rails and telescopic rails with partial pull-out. Drawers which are fully extendible can be pulled out fully from the appliance. Drawers with partial pull-out cannot be removed fully from the appliance. The system in your appliance depends on the type of appliance.

Partial pull-out fridge compartment

Removing drawer

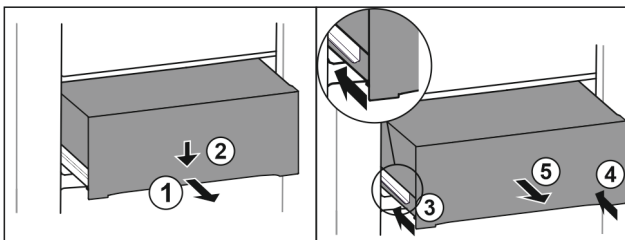

Fig. 104

- ▶ Pull out drawer half-way. Fig. 104 (1)
- ▶ Push the drawer down at the front. Fig. 104 (2)
- ▶ Push the left rail in by about 2 cm. Fig. 104 (3)
- ▶ Push the right rail in by about 2 cm. Fig. 104 (4)
- ▶ Remove drawer to the front. Fig. 104 (5)

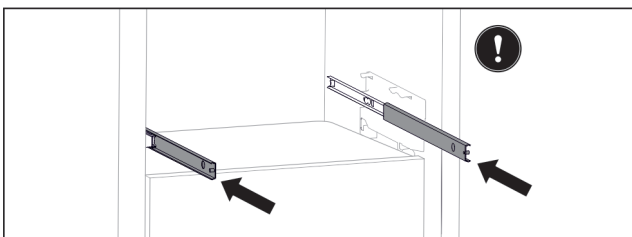

Fig. 105

If the rails are not yet fully inserted after removing the drawer:

- ▶ Push rails in completely.

Inserting drawer

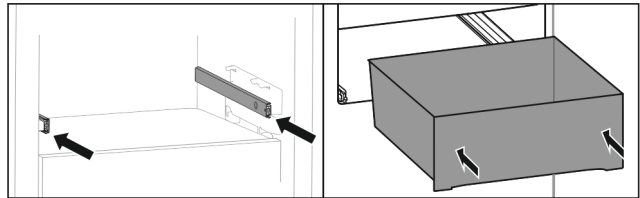

Fig. 106

- ▶ Slide rails in.
- ▶ Place drawer on rails.
- ▶ Slide in drawer to the back.

8.8 EasyFresh-Safe cover

You can remove the compartment cover for cleaning.

8.8.1 Removing the compartment cover

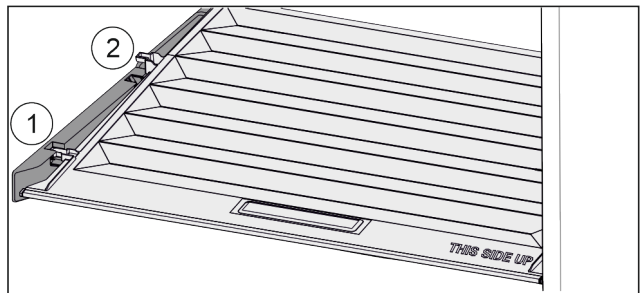

Fig. 107

When the drawers are removed:

- ▶ Pull the lid up at the front to the opening in the retaining parts Fig. 107 (1).
- ▶ Lift from the back and pull it up and out Fig. 107 (2).

8.8.2 Inserting the compartment cover

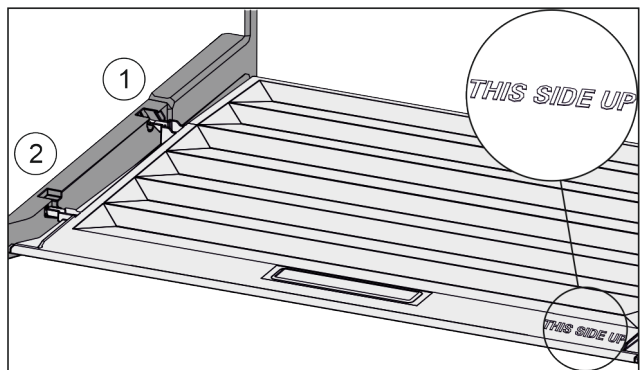

Fig. 108

If the text THIS SIDE UP points upwards:

- ▶ Insert the lip of the cover over the opening of the rear bracket Fig. 108 (1) and click into place Fig. 108 (2).
- ▶ Position the cover where you want it (see 8.9 Adjusting the moisture levels).

8.9 Adjusting the moisture levels

You can adjust the moisture in the drawer yourself by adjusting the compartment cover.

The compartment lid is attached to the drawer and can be hidden by a shelf or additional drawers.

Features

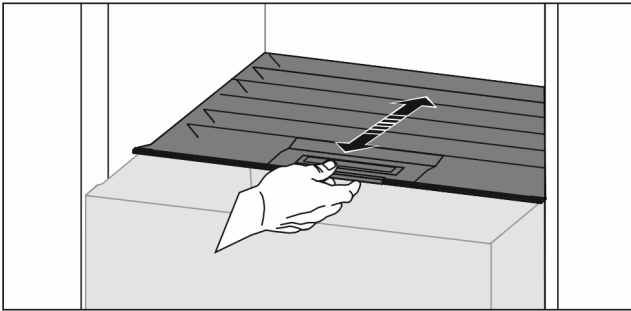

Fig. 109

Low air humidity

- ▶ Open the drawer.
- ▶ Slide the compartment cover forwards.
- ▷ With the drawer closed: Gap between the cover and the compartment.
- ▷ The air moisture in the Safe decreases.

High air moisture

- ▶ Open the drawer.
- ▶ Slide the cover back.
- ▷ With the drawer closed: The cover seals the compartment.
- ▷ The air moisture in the Safe increases.
- ▷ If there is too much moisture in the compartment:
- ▶ Choose the setting "low air moisture".

-or-

- ▶ Remove any excess moisture with a cloth.

8.10 Pull-out board with bottle basket*

Removable bottle baskets on the pull-out board offer plenty of space to store bottles. You can remove the bottle baskets to make room for a drinks crate in the pull-out board.

8.10.1 Using the bottle basket

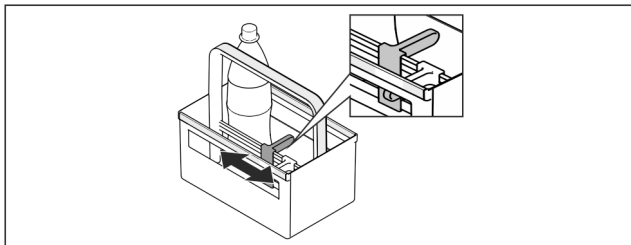

Fig. 110

- ▶ Slide the bottle rack at the edges.
- ▷ The bottles are prevented from falling over.

8.10.2 Disassembling the pull-out board

The pull-out board is mounted on a glass panel with pull-out rails.

You can dismantle the pull-out board for cleaning.

Removing the pull-out board

- ▶ Remove the bottle baskets.

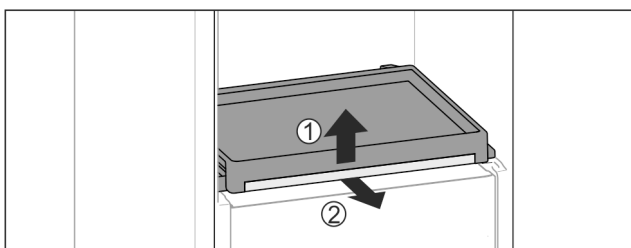

Fig. 111

- ▶ To remove the pull-out board with glass panel: Gently lift the glass panel at the front Fig. 111 (1) and pull out to the front Fig. 111 (2).

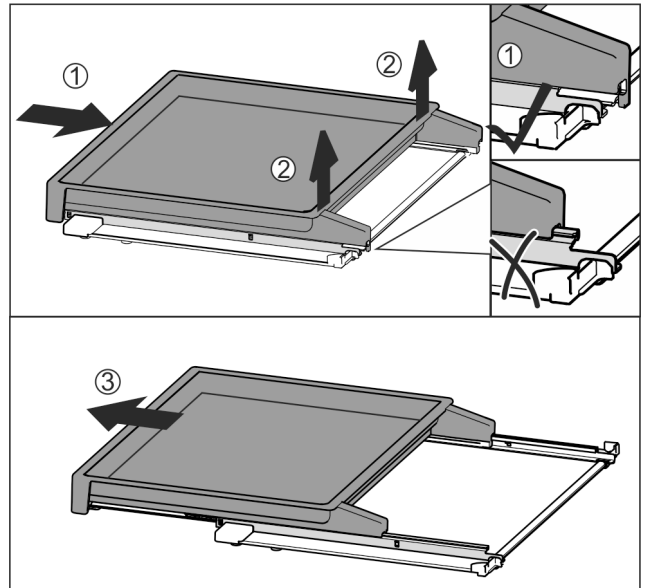

Fig. 112

- ▶ Slide the pull-out board all the way in Fig. 112 (1).
- ▶ Release the clips at the back Fig. 112 (2).
- ▶ Remove the pull-out board from the front Fig. 112 (3).

Inserting the pull-out board

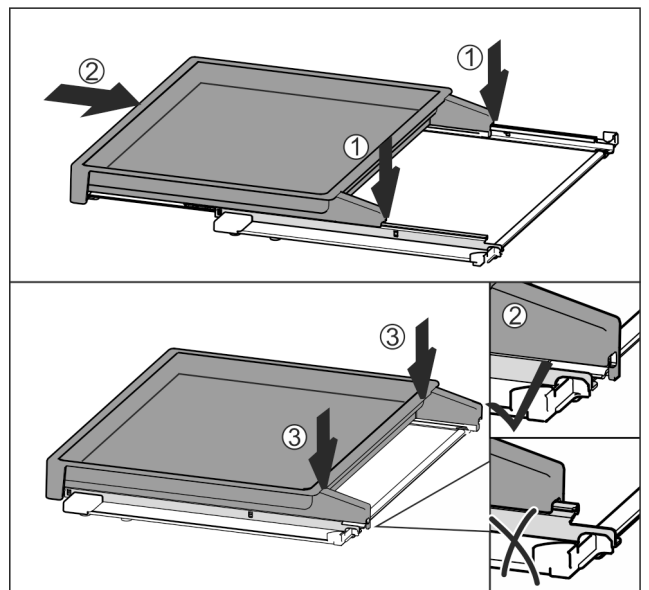

Fig. 113

- ▶ Place centrally on the rails Fig. 113 (1).
- ▶ Slide the pull-out board all the way in Fig. 113 (2).
- ▶ Press down at the back until it clicks into place Fig. 113 (3).
- ▶ To insert the pull-out board with glass panel: Slide to the rear.

8.11 Glass shelves*

You can remove the glass shelves under the drawers for cleaning.

8.11.1 Removing / inserting the glass shelf

Make sure that the following requirements are fulfilled:

- Glass shelf under the drawer: The drawer has been removed. (see 8.7 Drawers)
- Pull-out board under the bottle basket: Bottle basket has been removed. (see 8.10 Pull-out board with bottle basket*) *

Removing glass shelf

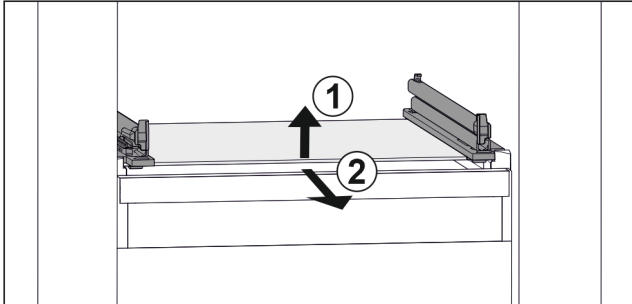

Fig. 114 Example illustration of glass shelf

- ▶ Lift glass shelf at the front. Fig. 114 (1)
- ▶ Take out glass shelf to the front. Fig. 114 (2)

Inserting glass shelf

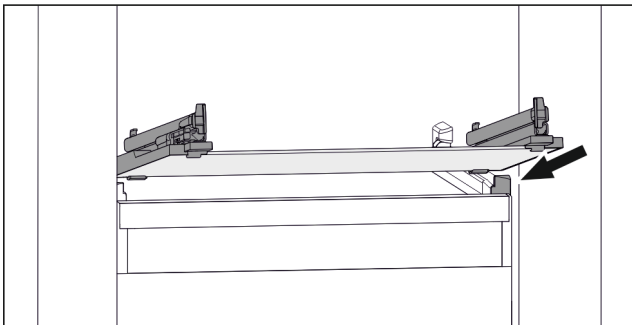

Fig. 115 Example illustration of glass shelf

- ▶ Position glass shelf at an angle behind the stoppers. (see Fig. 115)
- ▶ Lower glass shelf.
- ▶ Slide in glass shelf to the back.

8.12 Bottle holder

8.12.1 Using the bottle holder

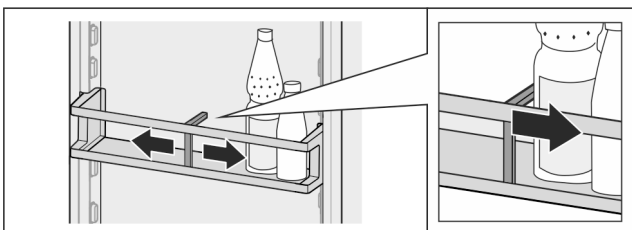

Fig. 116

- ▶ Push the bottle holder onto the bottles.
- ▶ The bottles are prevented from falling over.

8.12.2 Removing the bottle holder

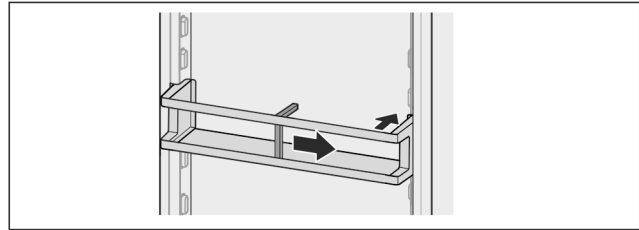

Fig. 117

- ▶ Move the bottle holder all the way to the right.
- ▶ Push the bottle holder to the back to remove.

9 Maintenance

9.1 FreshAir carbon filter*

The FreshAir carbon filter is in the compartment above the fan.

It guarantees the best air quality.

- Replace the carbon filter every 6 months.
When the reminder is set, a message on the display prompts you to change it.
- The carbon filter can be disposed of with the regular household waste.

Note

FreshAir activated charcoal filters can be purchased from the Liebherr-Hausgeräte store at home.liebherr.com/shop/de/deu/zubehor.html.

9.1.1 Removing the FreshAir carbon filter

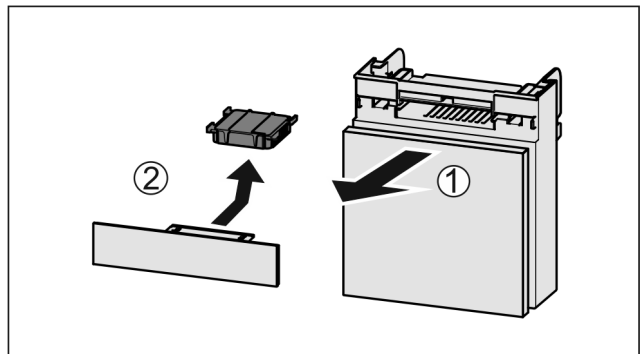

Fig. 118

- ▶ Pull out the compartment Fig. 118 (1).
- ▶ Remove the carbon filter Fig. 118 (2).

9.1.2 Inserting the FreshAir carbon filter

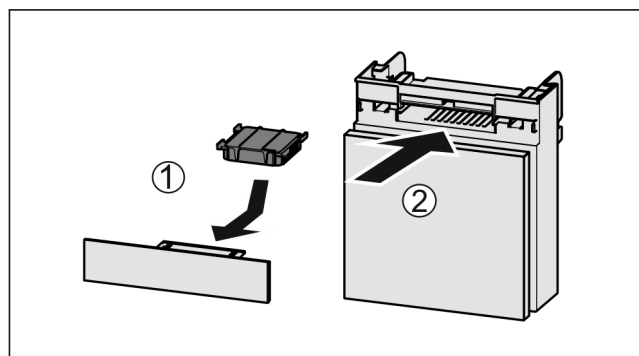

Fig. 119

- ▶ Insert the carbon filter as shown in the diagram Fig. 119 (1).

Maintenance

- ▷ The carbon filter clicks into place.
If the carbon filter is pointing downwards:
- ▶ Push the compartment in *Fig. 119 (2)*.
- ▷ The carbon filter is now ready for use.

9.2 Disassembling / assembling pull-out systems

9.2.1 Notes on disassembly

You can disassemble some of the pull-out systems for cleaning. Your appliance can contain a variety of pull-out systems.

The following pull-out systems can be disassembled or cannot be disassembled:

Pull-out system	can be disassembled / cannot be disassembled
Drawer on appliance base or glass shelf	cannot be disassembled
Drawer on rails	cannot be disassembled
Fridge section partial pull-out	cannot be disassembled
Pull-out shelf with bottle basket*	can be disassembled (see 9.2.2 Pull-out board with bottle basket*) *

9.2.2 Pull-out board with bottle basket*

Disassembling pull-out system

Make sure the following prerequisites are met:

- Bottle basket has been removed. (see 8.10 Pull-out board with bottle basket*)
- Glass shelf has been removed. (see 8.11 Glass shelves*)

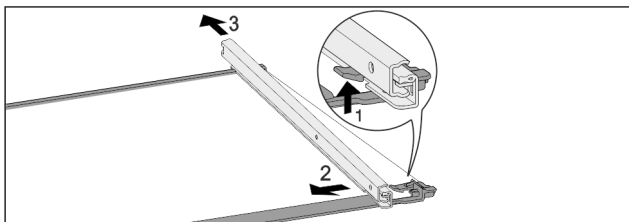

Fig. 120 Glass shelf with rails

- ▶ Push up front click-in hooks. *Fig. 120 (1)*
- ▶ Move the pull-out rails to the side *Fig. 120 (2)* and to the rear *Fig. 120 (3)*.

Installing pull-out system

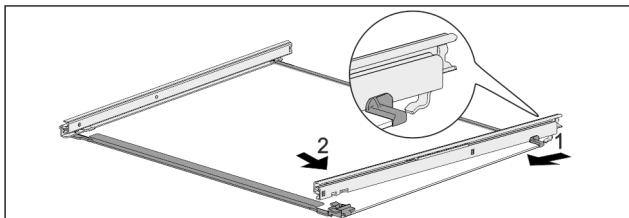

Fig. 121 Glass shelf with rails

- ▶ Hook in rail at the back. *Fig. 121 (1)*
- ▶ Hook in rail at the front. *Fig. 121 (2)*

9.3 Defrosting the appliance



WARNING

Improper defrosting of the appliance!
Injuries and damage.

- ▶ Do not use mechanical equipment or other methods to speed up the defrosting process other than those recommended by the manufacturer.
- ▶ Do not use electrical heating or steam-cleaning appliances, naked flames or defroster sprays to defrost.
- ▶ Do not use sharp objects to remove ice.

Defrosting is performed automatically. The water from the thawing process drains through the outlet and evaporates.

Water drops or a thin layer of frost or ice can form on the back wall; this is a completely normal part of the appliance's function. This must not be removed.

A layer of frost or ice can form briefly due to the energy-optimised control of the device.

- ▶ Clean the drain opening at regular intervals. (see 9.5 Cleaning the appliance)

9.4 Defrosting the freezer compartment manually*

A layer of frost or ice forms after prolonged use.

The following factors promote the formation of frost or ice:

- The appliance is opened frequently.
- Hot food is put in.
- ▶ Switch the appliance off.
- ▶ Pull the mains plug out of the socket or switch the fuse off.
- ▶ Wrap the frozen food in newspaper or blankets and store in a cool place.

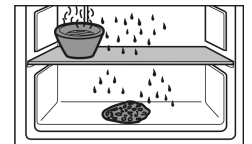

- ▶ Place a pan of hot water (not boiling) on the middle shelf.
- ▷ This speeds up the defrosting process.
- ▶ Leave the compartment and appliance door open during defrosting.
- ▶ Remove loosened pieces of ice.
- ▶ Soak up the melted ice water with a sponge or cloth several times as necessary.
- ▶ Clean the appliance. (see 9.5 Cleaning the appliance)

9.5 Cleaning the appliance

9.5.1 Ready



WARNING

Danger of electric shock!

- ▶ Remove the refrigerator connector or interrupt the power supply.



WARNING

Risk of fire

- ▶ Do not damage the refrigeration circuit.

- ▶ Empty the appliance.
- ▶ Remove mains connector.

-or-

- ▶ Activate CleaningMode. (see CleaningMode)

9.5.2 Cleaning the interior

NOTICE

Improper cleaning!
Damage to the appliance.

- ▶ Only use soft cleaning cloths and ph-neutral all-purpose cleaners.
- ▶ Do not use abrasive sponges or steel wool which may cause scratches.
- ▶ Do not use any sharp or abrasive cleaning agents, nor any that contain sand, chloride or acid.

- ▶ Plastic surfaces: clean by hand with a soft clean cloth, lukewarm water and a little detergent.
- ▶ Metal surfaces: clean by hand with a soft clean cloth, lukewarm water and a little detergent.
- ▶ Drain hole: remove deposits using a thin item (for example a cotton bud).

9.5.3 Clean the components

NOTICE

Improper cleaning!
Damage to the appliance.

- ▶ Only use soft cleaning cloths and ph-neutral all-purpose cleaners.
- ▶ Do not use abrasive sponges or steel wool which may cause scratches.
- ▶ Do not use any sharp or abrasive cleaning agents, nor any that contain sand, chloride or acid.

Clean with a soft, clean cloth, lukewarm water and some detergent:

- Door rack
- Shelf
- Dividing shelf*
- VarioSafe*
- Bottle basket and pull-out panel*
- EasyFresh-Safe cover
- Drawer

Clean with a damp cloth:

- Retractable rails
Please note: The grease in the tracks is used for lubrication and must not be removed!

Wash in the dishwasher up to 60 °C:

- Bottle rack
- Holder of the dividing shelf*
- Ice cube tray*
- FlexCube*
- ▶ To disassemble components: see the relevant section.
- ▶ Clean the components.

9.5.4 After cleaning

- ▶ Wipe the appliance and the components dry.
- ▶ Connect and switch on the appliance.
The temperature is cold enough:
- ▶ Place the food inside.
- ▶ Repeat cleaning regularly.

10 Customer help

10.1 Technical specifications

Temperature range	
Cooling	2 °C to 9 °C

Maximum freezing quantity/24 h		
Freezer compartment*		See "Freezing capacity .../24 h" on the type plate*

Maximum component capacity			
Features	Appliance width	Appliance width	Appliance width
	550 mm (see installation instructions, appliance dimensions)	600 mm (see installation instructions, appliance dimensions)	700 mm (see installation instructions, appliance dimensions)
Pull-out board*	20 kg*	20 kg*	20 kg*

Maximum size baking tray*	
Width	466 mm
Depth	386 mm
Height	50 mm

Lighting	
Class ¹	Light source
This product contains one or more energy efficiency class G light sources.	LED

¹ The appliance may contain light sources with different energy efficiency classes. The lowest energy efficiency class is indicated.

For appliances with a WiFi connection:*

Frequency specification*	
Frequency band	2.4 GHz
Maximum radiated power	< 100 mW
Purpose of the wireless equipment	Integration in the local WiFi network for data communication

10.2 Operating noises

The appliance makes different noises when it is on.

- At **higher temperatures** the appliance uses less energy but works for longer. It is **quieter**.
- At **lower temperatures** the food is cooled faster. It is **louder**.

Examples:

- Functions on (see 7.2 Appliance functions)
- Fan running*
- Food recently added
- High ambient temperature
- Door open for a while

Noise	Possible cause	Type of noise
Bubbling splashing and	Coolant flowing into the cooling circuit.	Normal operating noise
Hissing	Coolant sprays into the cooling circuit.	Normal operating noise

Customer help

Noise	Possible cause	Type of noise
Humming	The appliance is cooling. The volume depends on the cooling output.	Normal operating noise
Suction noises*	Soft-closing door is being opened and closed.*	Normal operating noise*
Humming and rustling*	The fan is running.*	Normal operating noise*
Clicking	Components are switched on and off.	Normal switching noise
Rattling humming or	Valves or flaps are working.	Normal switching noise

Noise	Possible cause	Type of noise	Lifting
Vibration	Improper installation	Defective noise	Check the installation. Level the appliance.

Noise	Possible cause	Type of noise	Lifting
Rattling	Components, items inside the appliance	Defective noise	Secure components. Leave enough space between the items.

10.3 Technical fault

Your appliance is designed and built to ensure it works reliably and has a long service life. In the unlikely event that a fault occurs during operation, please check whether it is due to an operating error. If so, you will be charged for the callout and repair costs even if it falls within the warranty period.

You can fix the following faults yourself.

10.3.1 Appliance function

Defect	Cause	Remedy
The appliance is not working.	→ The appliance is not switched on.	▶ Switch the appliance on.
	→ The power plug is not properly plugged into the socket.	▶ Check the power plug.
	→ There is something wrong with the power outlet fuse.	▶ Check the fuse.
	→ Power cut	▶ Keep the appliance closed. ▶ Safeguarding food: Place cold packs on top of food or use another freezer if the power cut lasts longer.* ▶ Do not refreeze defrosted food.*
	→ The IEC socket is not plugged into the appliance correctly.	▶ Check the IEC socket.
Temperature is not cold enough.	→ The appliance door is not closed properly.	▶ Close the appliance door.
	→ Not enough ventilation.	▶ Keep ventilation grille clear, and clean it.
	→ The ambient temperature is too high.	▶ Problem solution: (see 1.4 Appliance range of use)
	→ The appliance was opened too many times or for too long.	▶ Wait to see if the required temperature corrects itself. If not, contact Customer Service. (see 10.4 Customer Service)
	→ The temperature is set incorrectly.	▶ Turn down the temperature and check after 24 hours.
	→ The appliance is too close to a heat source (oven, radiator, etc).	▶ Move the appliance or the heat source.
	→ The appliance was not correctly installed in the recess.	▶ Check if the appliance was installed correctly and that the door closes properly.
The door seal is defective or needs to be replaced for another reason.	→ The door seal can be replaced. It can be replaced without the need for special tools.	▶ Contact Customer Service. (see 10.4 Customer Service)
The appliance builds up too much	→ The door seal may have slipped out of its groove.	▶ Check that the door seal is well fitted in the groove.

Defect	Cause	Remedy
ice or condensation.		

10.3.2 Features

Defect	Cause	Remedy
The internal light does not come on.	→ The appliance is not switched on.	▶ Switch the appliance on.
	→ The door was open for longer than 15 minutes.	▶ Interior lighting switches off automatically after about 15 minutes when the door is open.
	→ The LED interior light is faulty or the lid is damaged.	▶ Contact Customer Service. (see 10.4 Customer Service)
The freezer compartment cannot be closed.*	→ The lock is on when the door is open.	▶ Use the handle again.

10.4 Customer Service

First check whether you can rectify the fault yourself (see 10 Customer help) . If you cannot rectify the problem, contact Customer Service.

You can find the address in the enclosed brochure "Liebherr-Service" or at home.liebherr.com/service.



WARNING

Unprofessional repair!
Injuries.

- ▶ Have any repairs and action - not expressly specified - on the appliance and mains cable carried out by service personnel only. (see 9 Maintenance)
- ▶ A damaged mains cable may only be replaced by the manufacturer, the manufacturer's Customer Service or a similarly qualified person.
- ▶ In the case of appliances with an IEC connector, the change may be made by the customer.

10.4.1 Contacting Customer Service

Make sure that the following appliance information is available:

- Appliance name (model and index)
- Service no. (Service)
- Serial no. (S no.)

- ▶ Call up the appliance information via the display. (see Device information)

-or-

- ▶ Refer to the type plate for appliance information. (see 10.5 Model plate)
- ▶ Note down the appliance information.
- ▶ Notify customer service: Report errors and the appliance information.
- ▷ This will help us to provide you with a faster, more accurate service.
- ▶ Follow further instructions from Customer Service.

10.5 Model plate

The model plate is behind the drawers on the inside of the appliance.

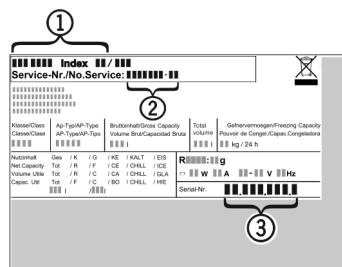

Fig. 122

- (1) Appliance description
 - (2) Service no.
 - (3) Serial no.
- ▶ Note the data on the model plate.

11 Shutting down

- ▶ Empty the appliance.
- ▶ Switch off appliance. (see Switching the appliance off and on)
- ▶ Pull the mains plug out of the socket.
- ▶ Remove the IEC socket if required: Pull the IEC socket out of the appliance plug and move it to the left and right at the same time.
- ▶ Clean appliance. (see 9.5 Cleaning the appliance)
- ▶ Leave the door open, so that no unpleasant odours arise.

12 Disposal

12.1 Preparing appliance for disposal



Liebherr uses batteries in some of its appliances. In the EU, for environmental reasons, legislation obliges the end user to remove these batteries before disposing of old appliances. If your appliance contains batteries, a corresponding notice is attached.

Lamps

If you can remove the lamps yourself without destroying them, also remove these before disposal.

- ▶ Take the appliance out of operation.
- ▶ If possible: remove lamps without destroying them.

Disposal

12.2 Disposing of the appliance in an environmentally friendly manner



The appliance still contains valuable materials and must be disposed of separately from unsorted municipal waste.



Li-Ion



Li-Ion

Dispose of batteries separately from the old appliance. To do this, you can return the batteries free of charge to retailers as well as recycling centres and collection centres for recyclable materials.

Lamps

Dispose of removed lamps via the respective collection systems.

For Germany:

You can dispose of the appliance free of charge via the class 1 collection containers at the local recycling and recyclable material collection centres. When purchasing a new fridge/freezer, if the sales area > 400 m², retailers will also take back the old appliance free of charge.



WARNING

Leaking coolant and oil!

Fire. The coolant contained in the appliance is eco-friendly, but also flammable. The oil contained in the appliance is flammable. Escaping coolant and oil can ignite if the concentration is high enough and in contact with an external heat source.

▶ Do not damage the pipelines of the coolant circuit and the compressor.

-
- ▶ Observe the notes on transporting the appliance.
 - ▶ Transport the appliance without damaging it.
 - ▶ Dispose of batteries, lamps and the appliance according to the above specifications.



home.liebherr.com/fridge-manuals

EN integrated fridge

Issue date: 20240902

Part number index: 7088433-00

Liebherr-Hausgeräte GmbH
Memminger Straße 77-79
88416 Ochsenhausen
Deutschland