

User Guide

Quality, Design and Innovation

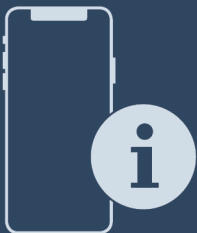

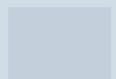







home.liebherr.com/fridge-manuals



LIEBHERR

Contents

1	The appliance at a glance.....	3		Door alarm.....	19
1.1	Delivered contents.....	3		Input lock.....	19
1.2	Appliance and equipment overview.....	3		Language.....	20
1.3	SmartDevice.....	4		Appliance information.....	20
1.4	Range of appliance use.....	4		Software.....	20
1.5	Conformity.....	4		Reminder.....	21
2	General safety instructions.....	4		Demo mode.....	21
3	Functionality of the Touch & Swipe display.....	7		Resetting to factory settings.....	22
3.1	Navigation and symbol explanation.....	7			
3.2	Menus.....	8			
3.3	Sleep mode.....	8			
4	Start-up.....	9			
4.1	Switching on appliance (first use).....	9			
4.2	Starting the IceMaker for the first time.....	9			
5	Storage.....	9			
5.1	Information regarding storage.....	9			
5.2	Freezer compartment.....	9			
5.3	Storage times.....	10			
6	Energy saving.....	11			
7	Use.....	11			
7.1	Controls and displays.....	11			
7.1.1	Status display.....	11			
7.1.2	Display symbols.....	11			
7.2	Appliance functions.....	11			
7.2.1	Notes on the appliance functions.....	11			
	Switching appliance off and on.....	11			
	WiFi.....	12			
	Temperature.....	13			
	Temperature unit.....	13			
	SuperFrost.....	14			
	Start defrost cycle.....	14			
	PartyMode	15			
	SabbathMode.....	15			
	EnergySaver	16			
	IceMaker / MaxIce	16			
	IceMaker water inflow.....	18			
	TubeClean	18			
	Display Brightness.....	19			
	7.3 Messages.....	22			
	7.3.1 Overview of warnings.....	22			
	7.3.2 Ending warnings.....	23			
	7.3.3 Overview of reminders.....	23			
	7.3.4 Ending reminders.....	24			
8	Equipment.....	24			
8.1	Drawers.....	24			
8.2	Pull-out board with IceTower.....	26			
8.3	Glass shelves.....	28			
8.4	IceMaker.....	28			
8.5	VarioSpace.....	28			
8.6	Freezer packs.....	28			
9	Maintenance.....	29			
9.1	Disassembling / assembling pull-out systems.....	29			
9.2	Defrosting the appliance.....	30			
9.3	Cleaning the appliance.....	30			
10	Customer support.....	32			
10.1	Technical specifications.....	32			
10.2	Operating noises.....	32			
10.3	Technical faults.....	33			
10.4	Customer Service.....	34			
10.5	Rating plate.....	34			
11	Decommissioning.....	35			
12	Disposal.....	35			
12.1	Preparing the appliance for disposal.....	35			
12.2	Disposing of the appliance in an environmentally friendly manner.....	35			

Congratulations on the purchase of your new appliance. With this purchase, you have chosen all the advantages of the latest refrigeration technology, guaranteeing you a high-quality appliance with a long life span and high operating safety.







The equipment of your appliance gives you the highest level of day-to-day ease of operation.

Together we are making an active contribution to the conservation of our environment by purchasing this

appliance which is manufactured in an environmentally friendly process with the use of recyclable materials.

We hope you enjoy your new appliance.

The manufacturer is constantly working to improve all types and models. Therefore, please be aware that we reserve the right to make changes to the shape, equipment and technology.

Symbol	Explanation
	Read instructions Please read the information in these instructions carefully to understand all of the benefits of your new appliance.
	Additional information online The digital manual with supplemental information can be found online by scanning the QR code on the front page of this manual or by entering the service number at home.liebherr.com/fridge-manuals .
	Check appliance Check all parts for transport damage. If you have any complaints, please contact your agent or customer service.
	Differences These instructions apply to a range of models, so there may be differences. Sections that apply to certain models only are indicated by an asterisk (*).
	Instructions and results Instructions are marked with a ▶. Results are marked with a ▷.
	Videos Videos about the appliances are available on the YouTube channel of Liebherr-Hausgeräte.

These operating instructions apply to:

SF 5291

1 The appliance at a glance

1.1 Delivered contents

Check all parts for transport damage. If you have any complaints, please contact the retailer or customer service. (see 10.4 Customer Service)

Delivery contains the following parts:

- Standalone appliance
- Equipment (depending on your model)
- Installation parts (depending on your model)
- User Guide

- Installation Guide
- Warranty documents

1.2 Appliance and equipment overview

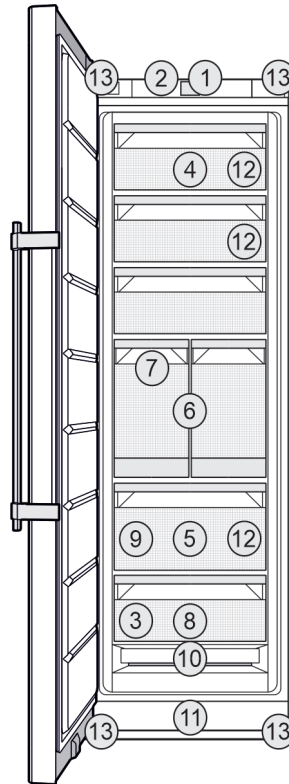

Fig. 1 Example illustration

Equipment

- | | |
|-----------------------------|---|
| (1) Control elements | (8) Freezer tray, cold storage accumulators |
| (2) Lighting | (9) Ice cube scoop |
| (3) Serial tag | (10) NoFrost |
| (4) Tilting drawer | (11) Ventilation slit |
| (5) SpaceBox | (12) VarioSpace |
| (6) IceTower | (13) Adjustable feet (front), transport castors (rear), transport handles at the top (rear) and bottom (front) |
| (7) IceMaker | |

Note

- ▶ The shelves, drawers, and baskets are arranged for optimal energy efficiency in the factory configuration. However, changes to the arrangement within the given insertion options – for example the arrangement of shelves in the fridge compartment – have no effect on energy consumption.

General safety instructions

1.3 SmartDevice

SmartDevice is the networking solution for your freezer.

If your appliance is SmartDevice-enabled or compatible, you can quickly and easily connect your appliance to your WiFi. With the SmartDevice app, you can operate your appliance from a mobile device. Additional functions and setting options are available in the SmartDevice app.

SmartDevice-enabled appliance: Your appliance is capable of being a SmartDevice. To be able to connect your device to WiFi, you need to download the SmartDevice app.



More information about SmartDevice: smartdevice.liebherr.com

Downloading the SmartDevice app:



After installing and configuring the SmartDevice app, you can connect your appliance to the WiFi using the SmartDevice app and the WiFi appliance function (see WiFi).

1.4 Range of appliance use

Normal use

This appliance is intended to be used in household and similar applications such as,

- staff kitchen areas in shops, offices and other working environments;
- farm houses and by clients in hotels, motels and other residential type environments;
- bed and breakfast type environments;
- catering and similar non-retail applications.

The appliance is not suitable as a built-in unit; All other types of uses are not permitted.

Foreseeable misuse

The following uses are specifically prohibited:

- Storage and cooling of medication, blood plasma, laboratory preparations or similar substances and products in accordance with the CMDCAS and FDA 510(k)

- Use outdoors
- Use in moist areas exposed to the rain
- Use in outdoor areas with very high humidity
- Use in areas at risk of explosion

Incorrect appliance use can cause damage to the stored products or cause them to spoil.

Climate ratings

The appliance is set to operate within specific ambient temperature limits according to its climate rating. The climate rating for your appliance is printed on the rating plate.

Note

► To guarantee trouble-free operation, comply with the indicated ambient temperatures.

Climate rating	for ambient temperatures from
SN	10 °C (50 °F) to 32 °C (90 °F)
N	16 °C (61 °F) to 32 °C (90 °F)
ST	16 °C (61 °F) to 38 °C (100 °F)
T	16 °C (61 °F) to 43 °C (109 °F)
SN-ST	10 °C (50 °F) to 38 °C (100 °F)
SN-T	10 °C (50 °F) to 43 °C (109 °F)

1.5 Conformity

The refrigerant circuit has been tested for leaks. The appliance complies with the applicable safety regulations and with the corresponding directives.

2 General safety instructions

Please keep these operating instructions in a safe place so you can refer back to them at any time.

If you pass the appliance on, please hand these operating instructions to the new owner.

Read and follow these instructions. They contain safety information which is important for safe and problem-free installation and operation. Always read and follow the safety information.

Dangers for the user:

- This appliance is not intended for use by persons (including children) with reduced physical, sensory or mental capabilities, or lack of experience and knowledge, unless they have been given supervision or instruc-

General safety instructions

tion concerning use of the appliance by a person responsible for their safety. Children should be supervised to ensure that they do not play with the appliance. Cleaning and user maintenance must not be performed by children unless they are supervised. Children between the ages of 3 and 8 may load and unload the appliance. Children under the age of 3 must be kept away from the appliance unless they are constantly supervised.

- **IMPORTANT:** The power plug must be easily accessible so that the appliance can be disconnected from the mains quickly in an emergency. It must not be behind the back of the appliance.
- The socket must be easily accessible so that the appliance can be disconnected quickly from the electricity in an emergency. It must not be located in the area behind the appliance.
- Always hold the appliance at the plug when disconnecting it from the household power. Do not pull on the cable.
- Disconnect the power plug or fuse if there is a malfunction.
- Do not damage the power cable. Do not operate the appliance with a faulty power cable. If the supply cord is damaged, it must be replaced by the manufacturer, its service agent or similarly qualified persons in order to avoid a hazard. For Plug and Play connections, the change may be carried out by the customer.
- Repairs and work on the appliance may only be carried out by Customer Service or other specifically trained qualified personnel.
- Always follow the instructions when assembling, connecting and disposing of the appliance.
- The manufacturer is not liable for damage arising from a defective fixed water connection.

Risk of fire:

- The refrigerant contained within the appliance (specifications on the identification plate) is environmentally friendly, but flammable. Leaking refrigerant can ignite.
 - **WARNING:** Do not damage the refrigerant circuit.

- Do not handle ignition sources inside the appliance.
- **WARNING:** Do not use electrical appliances inside the food storage compartments of the appliance, unless they are of the type recommended by the manufacturer (e.g. steam cleaning appliances, heating appliances, ice cream makers).
- If refrigerant leaks: Remove naked flames or ignition sources located near the area of the leak. Ventilate the room well. Contact Customer Service.
- Do not operate the appliance near explosive gases.
- Do not store or use gasoline or other flammable gases and liquids near the appliance.
- Do not store explosive substances such as aerosol cans with a flammable propellant in this appliance. You can recognize such spray cans by the printed list of contents or by a flame symbol. Any leaking gases can be ignited by electrical components.
- Keep lit candles, lamps and other objects with naked flames away from the appliance so they do not cause a fire.
- Alcoholic beverages or other containers holding alcohol must always be tightly sealed for storage purposes. Any leaking alcohol can be ignited by electrical components.

Risk of falling or toppling over:

- **WARNING:** To avoid a hazard due to instability of the appliance, it must be fixed in accordance with the instructions.
- Do not stand on the base, drawers, doors etc. or use them as improper supports. This applies in particular to children.

Danger of poisoning:

- Do not consume spoiled food.
- **WARNING:** Connect to potable water supply only.
- Do not use any old or already premounted water supply lines.

Danger of frostbite, feeling of numbness and pain:

- Avoid prolonged skin contact with cold surfaces or chilled/frozen food or take protective measures, e.g. wear gloves.

Risk of injury and damage:

General safety instructions

- Hot steam may cause injuries. Do not use any electrical heating or steam cleaning equipment, naked flames or defrosting sprays for defrosting measures.
- **WARNING:** Do not use mechanical devices or other means to accelerate the defrosting process, other than those recommended by the manufacturer.
- Do not remove ice using sharp objects.
- **WARNING:** Keep clear of obstruction all ventilation openings in the appliance enclosure or in the structure for building-in.
- **WARNING:** Risk of child entrapment. Before you throw away your old refrigerator or freezer:
 - Take off the doors.
 - Leave the shelves in place so that children may not easily climb inside.

Risk of crushing:

- Do not hold onto the hinge when opening and closing the door. Fingers may become trapped.

California Proposition 65

- **WARNING:** This product can expose you to chemicals including Diisononyl Phthalate (DINP), which is known to the State of California to cause cancer, and Diisodecyl Phthalate (DIDP), which is known to the State of California to cause birth defects or other reproductive harm. For more information, go to www.P65Warnings.ca.gov

FCC Warning

- Changes or modifications not expressly approved by the party responsible for compliance could void the user's authority to operate the equipment.

FCC information

- This appliance has been tested and found to comply with the limits for a Class B digital device, pursuant to part 15 of the FCC Rules. These limits are designed to provide reasonable protection against harmful interference from an installation in residential areas. This appliance generates, uses and can radiate radio-frequency energy and, if not installed and used in accordance with the instructions, may cause harmful interference to radio communications. However, there is no guarantee that interference will not occur in a particular installation. If this appliance

does cause harmful interference to radio or television reception, which can be determined by switching the appliance on and off, the user should try to correct the interference by one or more of the following measures:

- Reorient or relocate the receiving antenna.
- Increase the distance between the appliance and receiver.
- Connect the appliance to an outlet on a circuit different from that to which the receiver is connected.
- Consult the dealer or an experienced radio/TV technician for help.

FCC Radio Frequency Exposure Statement

- This appliance is found to comply with FCC radio frequency (RF) exposure limits set for an uncontrolled environment. This transmitter must not be set up or operated in conjunction with another antenna or another transmitter.
- This appliance should be installed and operated with a minimum space of 200 mm (7 7/8 in) between the antenna and your body. The user must follow the specific operating instructions to ensure compliance with RF exposure.

IC information

- This appliance has license-exempt transmitters/receivers, which comply with the license-exempt Radio Standards Specification (RSS) of Innovation, Science and Economic Development Canada. Operation is subject to the following two conditions:
 - This appliance may not cause interference.
 - This device must accept any interference, including interference that may cause undesired operation of the device.

IC Radio Frequency Exposure Statement

- This appliance meets the IC RSS-102 limits for radiation exposure, which were defined for an uncontrolled environment. This appliance should be installed and operated so that there is a minimum space of 200 mm (7 7/8 in) between the antenna and your body.

Symbols on the device:

Functionality of the Touch & Swipe display



The symbol may be located on the compressor. It refers to the oil in the compressor and refers to the following danger: Can be fatal if swallowed or inhaled. This notice only applies for recycling. There is no danger during normal operation.



WARNING: Risk of fire / flammable materials. The symbol is located on the compressor and indicates the danger from flammable materials. Do not remove the label.



This label or a similar one may be located on the rear of the appliance. This label indicates that there are vacuum insulation panels (VIP) or perlite panels in the door and/or housing. This notice only applies for recycling. Do not remove the label.

Observe the warning messages and other detailed information in the other sections:

	DANGER	Indicates an immediately hazardous situation, which if not avoided, will result in death or serious injury.
	WARNING	Indicates a hazardous situation, which if not avoided, could result in death or serious injury.
	CAUTION	Indicates a hazardous situation, which if not avoided, could result in minor or moderate injury.
	NOTICE	Indicates a hazardous situation, which if not avoided, could result in damage to property.
	Note	Indicates useful advice and tips.

3 Functionality of the Touch & Swipe display

You operate your appliance using the Touch & Swipe display. You select appliance functions in the Touch & Swipe display (hereafter referred to as display) by tapping them. If you do not perform any action on the display for 10 seconds, the display either jumps back to the higher-level menu or directly to the status display.

3.1 Navigation and symbol explanation

In the illustrations, different symbols are used to navigate the display. The following table describes these symbols.

Symbol	Description
	Briefly touch the display: Activates/deactivates function. Confirms selection. Opens submenu.
	Touch the display for a specified time (e.g. 3 seconds): Activates/deactivates function or value.
	Swipe left or right: Navigate in the menu.
	Briefly touch the Back symbol: Jumps back one menu level.
	Press and hold the Back symbol for 3 seconds: Jumps back to the status display.
	Arrow with clock: It takes more than 10 seconds for the following message to appear in the display.
	Arrow with a time indication: It takes the specified amount of time until the following message appears in the display.
	“Open Settings menu” symbol: Navigates to the Settings menu and opens the settings menu. If necessary: Navigate to the desired function in the Settings menu. (see 3.2.1 Opening the Settings menu)

Functionality of the Touch & Swipe display

Symbol	Description
	<p>“Open Advanced menu” symbol: Navigates to the Advanced menu and opens the advanced menu. If necessary: Navigate to the desired function in the Advanced menu. (see 3.2.2 Opening expanded menu)</p>
No action for 10 seconds	If you do not perform any action on the display for 10 seconds, the display either jumps back to the higher-level menu or directly to the status display.
Open door and close it again.	If you open the door and immediately close it again, the display jumps directly back to the status display.

Note: Illustrations of the display are shown in the English version.

3.2 Menus

The appliance functions are distributed over various menus:

Menu	Description
Main menu	<p>When you switch the appliance on, you are automatically in the main menu. From here you can navigate to the most important appliance functions, to the Settings menu and to the Advanced menu.</p>
 Settings menu	The Settings menu contains additional appliance functions for setting up your appliance.
Advanced menu	The advanced menu contains special appliance functions for setting up your appliance. Access to the Advanced menu is protected by the numerical code 151 .

3.2.1 Opening the Settings menu

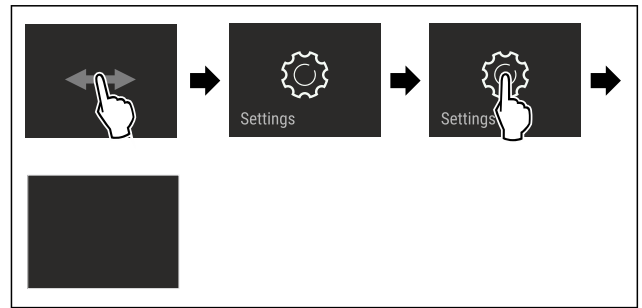

Fig. 2 Example illustration

- ▶ Carry out action steps according to the illustration.
- ▷ Settings menu is open.
- ▶ If necessary: Navigate to the desired function.

3.2.2 Opening expanded menu



Fig. 3

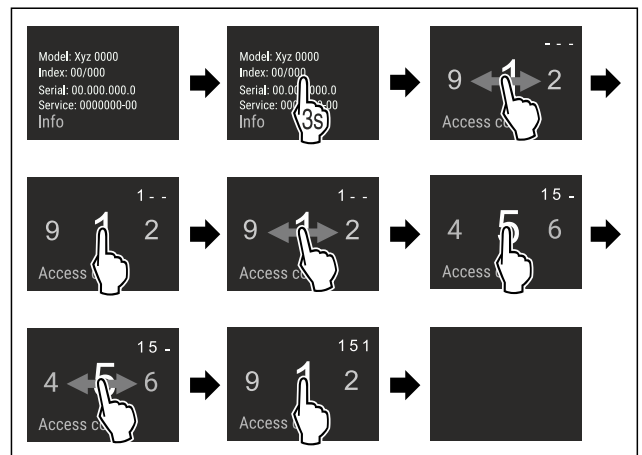

Fig. 4 Example illustration, access with numerical code **151**

- ▶ Carry out action steps according to the illustration.
- ▷ Expanded menu is open.
- ▶ If necessary: Navigate to the desired function.

3.3 Sleep mode

If you do not touch the display for 1 minute, the display switches to sleep mode. In sleep mode, the display brightness is dimmed.

3.3.1 Ending sleep mode

- ▶ Touch the display briefly with your finger.
- ▷ Sleep mode is ended.

4 Start-up

4.1 Switching on appliance (first use)

Make sure that the following requirements are fulfilled:

- ❑ The appliance has been installed and connected in accordance with the installation instructions.
- ❑ All adhesive strips, adhesive and protective films and transport locks are removed from inside and on the appliance.
- ❑ All marketing leaflets are removed from the drawers.
- ❑ You are familiar with the functionality of the Touch & Swipe display. (see 3 Functionality of the Touch & Swipe display)

Switch on the appliance using the Touch & Swipe display.

- ▶ If the display is in sleep mode: Briefly touch the display.
- ▶ Carry out action steps according to the illustration.

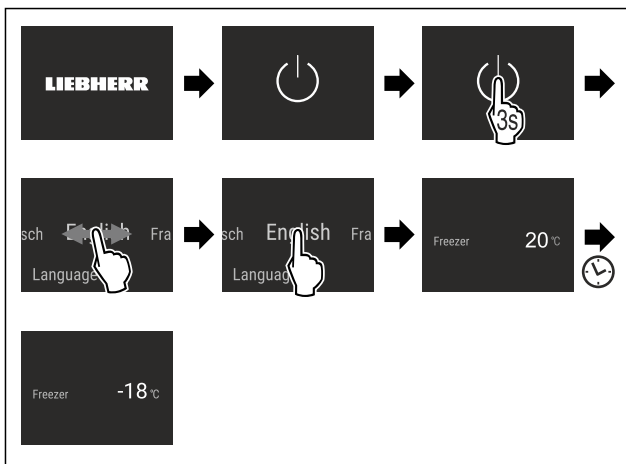

Fig. 5 Example illustration

- ▶ Status display appears.
- ▶ The appliance cools to the temperature set at the factory.
- ▶ The appliance starts in demo mode (status display with DEMO appears): If the appliance starts in demo mode, you can deactivate demo mode within the next 5 minutes. (see Demo mode)

More information:

- Start the IceMaker for the first time. (see 4.2 Starting the IceMaker for the first time)
- Start the SmartDevice for the first time. (see 1.3 SmartDevice) and (see WiFi)

Note

The manufacturer recommends:

- ▶ **Store frozen foods** at -18 °C (-0 °F) or colder.
- ▶ Observe the notes on storing food. (see 5.1 Information regarding storage)

Note

Accessories can be purchased from the Liebherr Service Center. The address for your respective country can be found on the back of the instructions.

4.2 Starting the IceMaker for the first time

If your appliance is equipped with IceMaker, you must clean the IceMaker **before using it for the first time**.

Make sure that the following requirements are fulfilled:

- ❑ The water supply has been connected. See Installation Guide or mounting instructions.
- ❑ The appliance is properly connected.
- ▶ Clean the IceMaker. (see 9.3.5 Cleaning the IceMaker)

5 Storage

5.1 Information regarding storage



WARNING

Danger of fire

- ▶ Do not use electrical appliances inside the food storage compartments of the appliance, unless they are of the type recommended by the manufacturer.

Note

Insufficient ventilation results in an increase in energy consumption and reduction of the refrigerating performance

- ▶ Always keep the air slots unobstructed.

Observe the following specifications for storage:

- Keep the air vents on the fan free.
- Package food properly.
- Package raw meat or fish in clean, closed containers. This will prevent meat or fish from touching or dripping onto other food.
- Leave space between goods to ensure good air circulation.
- Store food according to the instructions on the packaging.
- Always observe the best-before date indicated on the packaging.

Note

Failure to follow these guidelines can lead to food-stuffs spoiling.

5.2 Freezer compartment

Here, a dry, frosty storage climate is created at -18 °C (-0 °F). The frosty storage climate is suitable for storing frozen food for several months, for making ice cubes or freezing fresh food.

Storage

5.2.1 Freezing food

Freezing quantity

The maximum amount of fresh food that you can freeze within 24 hours is specified on the type plate (see 10.5 Rating plate) under “Freezing capacity ... kg/24h.”

To ensure that food quickly freezes through, adhere to the following quantities per package:

- Fruit and vegetables up to 1 kg (2.20 lb)
- Meat up to 2.5 kg (5.51 lb)

Freezing food using SuperFrost

Depending on the amount of food to be frozen, you can activate SuperFrost before freezing to reach lower freezing temperatures. (see SuperFrost)

- ▶ Activate SuperFrost if the amount of food you have to freeze is more than approx. 2 kg (4.41 lb).

The time at which you activate SuperFrost depends on the amount of food you have to freeze:

Freezing quantity	Time at which you should activate SuperFrost
Small amount of food to freeze	Activate SuperFrost about 6 hours before freezing. You can place the food in the freezer as soon as the appliance automatically deactivates SuperFrost.
Maximum amount of food to freeze	Activate SuperFrost about 24 hours before freezing. You can place the food in the freezer as soon as the appliance automatically deactivates SuperFrost.

Arranging your food properly



CAUTION

Risk of injury from broken glass!

Bottles and cans with beverages can burst during freezing. This applies in particular to carbonated beverages.

- ▶ Only freeze bottles and cans with beverages if you have activated the BottleTimer function in the SmartDevice app.

Freezing quantity	Arranging your food properly
Small amount of food to freeze	Place packaged food in the top drawer. If possible, place groceries at the back of the drawer near the rear wall.

Freezing quantity	Arranging your food properly
Maximum amount of food to freeze	Distribute packaged groceries throughout all drawers, but only store food that is already deep frozen in the bottom drawer. If possible, place groceries at the back of the drawer near the rear wall.

5.2.2 Defrosting food



WARNING

Danger of food poisoning!

- ▶ Do not re-freeze defrosted food.
- ▶ Use defrosted foodstuff as quickly as possible.

You can defrost food in several ways:

- In a refrigeration unit
- In the microwave
- In the oven/fan-assisted oven
- At room temperature
- ▶ Take out only as much food as necessary.

5.2.3 Freezer tray

You can freeze berries, herbs, vegetables and other small frozen food in the freezer tray without it all freezing together. The frozen food is less likely to get squashed and subsequent portioning is easier.

In addition, you can store the cold storage accumulators in the freezer tray to save space.

- ▶ Distribute food on the freezer tray without packaging and well spaced out.

5.3 Storage times

The storage times given are guidelines

Food with a “use by” date must still be consumed by the date indicated on the package

Guidelines for storage periods for various foods		
Ice cream	at -18 °C (-0 °F)	2 to 6 months
Sausage, ham	at -18 °C (-0 °F)	2 to 3 months
Bread, bakery products	at -18 °C (-0 °F)	2 to 6 months
Game, pork	at -18 °C (-0 °F)	6 to 9 months

Guidelines for storage periods for various foods		
Fish, fatty	at -18 °C (-0 °F)	2 to 6 months
Fish, lean	at -18 °C (-0 °F)	6 to 8 months
Cheese	at -18 °C (-0 °F)	2 to 6 months
Poultry, beef	at -18 °C (-0 °F)	6 to 12 months
Vegetables, fruit	at -18 °C (-0 °F)	6 to 12 months

6 Energy saving

- Always ensure good ventilation. Keep clear of obstruction all ventilation openings in the appliance enclosure or in the structure for building-in.
- Never block air slits in the fan.
- Do not set up the appliance in an area with direct sunlight, next to a heating unit or similar.
- If you set up the appliance directly next to an oven, its energy consumption may increase slightly. This depends on the service life and how often the oven is used.
- Energy consumption depends on installation conditions such as the ambient temperature (see 1.4 Range of appliance use) . A warmer ambient temperature can increase the energy consumption.
- Avoid opening the appliance door for any longer than necessary
- The lower the temperature is set the higher the energy consumption.
- All food stored in the appliance should be well wrapped and covered. This prevents frost buildup.
- Insertion of warm foods: first let the food cool down to room temperature.

7 Use

7.1 Controls and displays

7.1.1 Status display

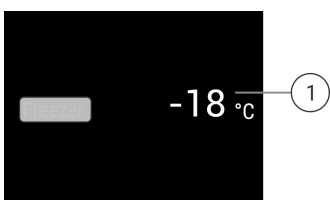







Fig. 6 Status display shows the actual temperature.

(1) Temperature display

The status display shows the actual temperature and is the initial display. You can navigate from there to the functions and settings.

7.1.2 Display symbols

The display symbols provide information about the current appliance status.

Symbol	Appliance status
	Standby The appliance or temperature zone is turned off.
	Flashing number Appliance is working. Temperature flashes until the set temperature is reached.
	
	Flashing symbol Appliance is working. Setting is made.
	

7.2 Appliance functions

7.2.1 Notes on the appliance functions

The appliance functions are set at the factory so that your appliance is fully functional.

Before you alter, activate or deactivate the appliance functions, make sure that the following requirements are met:

- You have read and understood the descriptions of how the display works. (see 3 Functionality of the Touch & Swipe display)
- You have familiarized yourself with the operating and display elements of your appliance.

Switching appliance off and on

This function switches the entire appliance on and off.

Switching off the appliance

If you switch off the appliance, the settings that were made before remain stored.

Make sure that the following requirements are fulfilled:

- Handling instructions (see 11 Decommissioning) have been completed.



Use

Fig. 7

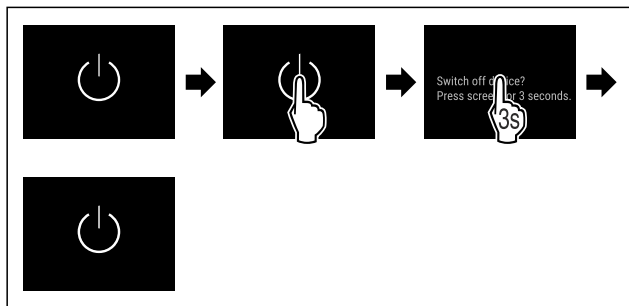

Fig. 8

- ▶ Carry out action steps according to the illustration.
- ▷ Appliance is switched off.
- ▷ Standby symbol appears in the display.
- ▷ Display turns black.

Switching on the appliance

If the display is in sleep mode:

- ▶ Briefly touch the display.

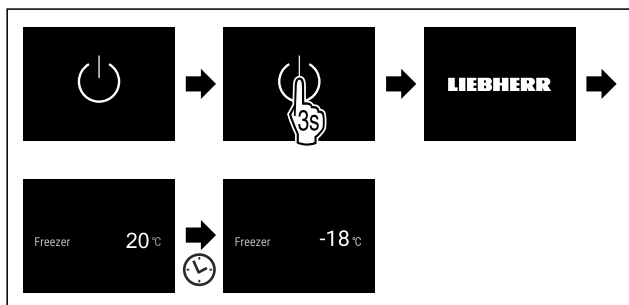

Fig. 9 Example illustration

- ▶ Carry out action steps according to the illustration.
- If the appliance starts in demo mode:
 - ▶ Deactivate demo mode. (see Deactivating demo mode)
- ▷ Appliance is switched on.
- ▷ Previously made settings are re-established.
- ▷ The appliance cools to the set target temperature.



WiFi

Use this function to connect your appliance to WiFi. You can then operate it via the SmartDevice app on a mobile device. You can also use this function to disconnect or reset the WiFi connection.

More information on the SmartDevice: (see 1.3 SmartDevice)

Note

The SmartDevice function is not available in the following countries: Russia, Belarus, Kazakhstan.

Establishing the WiFi connection for the first time

Make sure that the following requirements are fulfilled:

- You have installed the SmartDevice app (see apps.home.liebherr.com).
- Registration in the SmartDevice app is completed.



Fig. 10

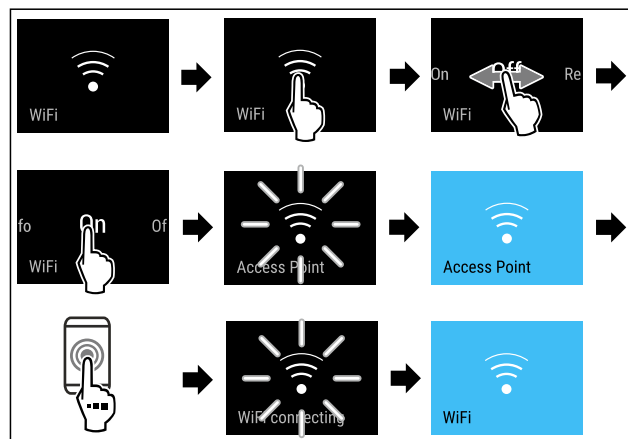

Fig. 11

- ▶ Carry out action steps according to the illustration.
- ▷ Connection is established.

Disconnecting from the WiFi



Fig. 12

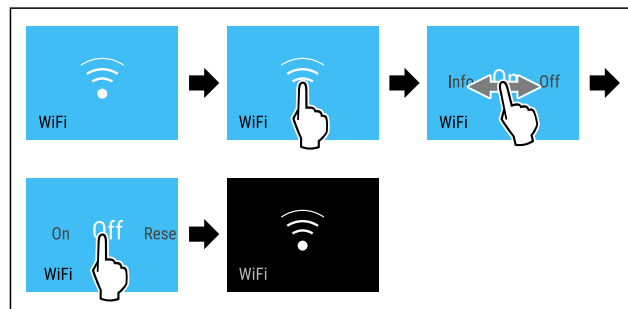

Fig. 13

- ▶ Carry out action steps according to the illustration.
- ▷ There is no connection.

Resetting the WiFi connection

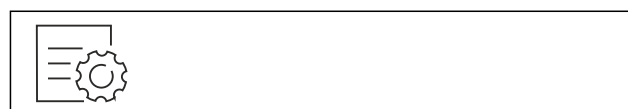

Fig. 14

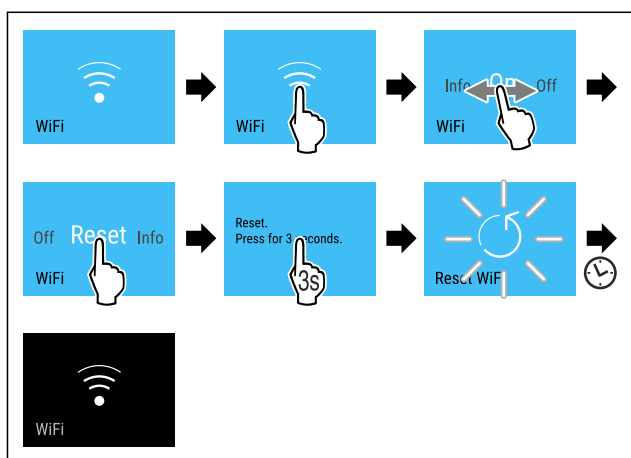

Fig. 15

- ▶ Carry out action steps according to the illustration.
- ▷ WiFi connection and other WiFi settings are reset to factory settings.

Showing information about the WiFi connection



Fig. 16

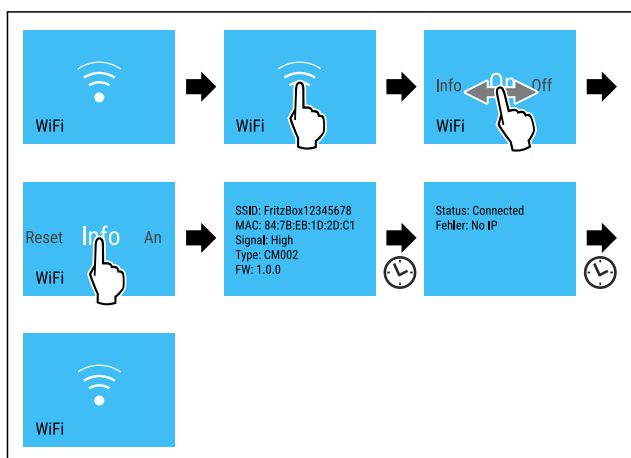

Fig. 17

- ▶ Carry out action steps according to the illustration.

-18°C Temperature

Use this function to set the temperature.

The temperature depends on the following factors:

- How often the door is opened
- How long the door is open
- The room temperature of the installation site
- Type, temperature and amount of food

Freezer compartment	Factory-set temperature	Recommended setting
-18°C	-18 °C (-0 °F)	-18 °C (-0 °F)

Setting the temperature

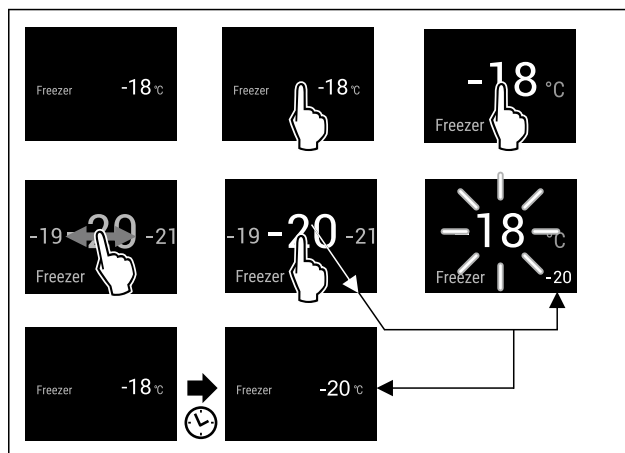

Fig. 18 Example illustration

- ▶ Carry out action steps according to the illustration.
- ▷ Temperature is set.

°C/°F Temperature unit

Use this function to set the temperature unit. You can set the temperature unit in either degrees Celsius or degrees Fahrenheit.

Setting the temperature unit



Fig. 19

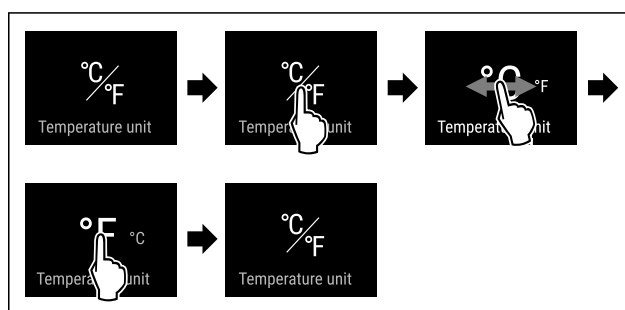

Fig. 20 Example illustration: Switching between degrees Celsius or degrees Fahrenheit.

- ▶ Carry out action steps according to the illustration.
- ▷ Temperature unit is set.

Use

SuperFrost

This function activates or deactivates SuperFrost. Activating SuperFrost the appliance increases the freezing capacity. This allows you to achieve lower freezer temperatures.

Application:

- Quickly freezing fresh food through to the core. This ensures that the nutrition value, look, and taste of the food is preserved.
- Increasing cold reserves in stored frozen food before defrosting the appliance.

If the function is active, the appliance operates at a higher output. As a result, the operating noise of the appliance may be temporarily louder, while energy consumption increases.

Activating SuperFrost

Make sure that the following requirements are fulfilled:

- The freezing volume and time for SuperFrost activation are taken into account. (see Freezing food using SuperFrost)



Fig. 21

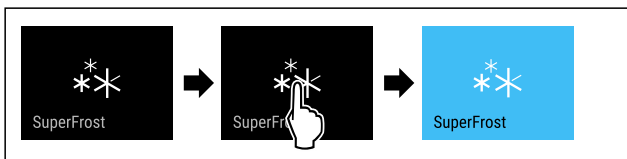

Fig. 22

- ▶ Carry out action steps according to the illustration.
- or-
- ▶ Activating with the SmartDevice app.
- ▷ SuperFrost is activated.
- ▷ Temperature display turns blue.

Deactivating SuperFrost

SuperFrost is automatically deactivated after 56 to 72 hours depending on the volume of the stored food. However, you can also manually deactivate SuperFrost at any time:



Fig. 23



Fig. 24

- ▶ Carry out action steps according to the illustration.
- or-
- ▶ Deactivating with the SmartDevice app.
- ▷ SuperFrost is deactivated.
- ▷ Appliance continues to run in normal operation.
- ▷ The appliance first cools to the set temperature.

Start defrost cycle

Use this function to start the automatic defrost cycle manually if the defrost cycle does not start automatically in case of an error.

Starting the defrost cycle

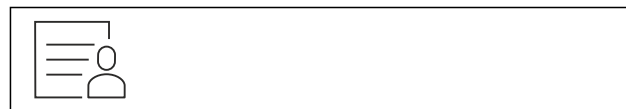

Fig. 25

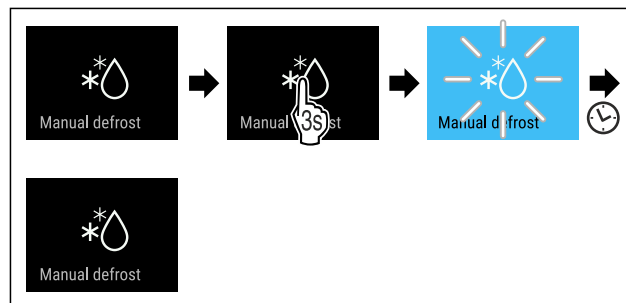

Fig. 26

- ▶ Carry out action steps according to the illustration.
- ▷ Defrost cycle has started: Symbol flashes until the defrost cycle is automatically completed.
- ▷ When the defrost cycle is completed: Appliance continues to run in normal operation.

Canceling the defrost cycle

The defrost cycle is automatically completed. However, you can also cancel the defrost cycle at any time during the defrosting:



Fig. 27

- ▶ Carry out action steps according to the illustration.
- ▷ Defrost cycle is canceled.
- ▷ Appliance continues to run in normal operation.



PartyMode

This function activates and deactivates PartyMode. PartyMode activates different functions that are useful for a party.

PartyMode activates the following functions:

- SuperFrost (see SuperFrost)
- IceMaker with MaxIce (see IceMaker / MaxIce)

You can set all listed functions individually and flexibly. By deactivating PartyMode all changes are discarded.

If the function is active, the appliance operates at a higher output. As a result, the operating noise of the appliance may be temporarily louder, while energy consumption increases.

Activating PartyMode

Make sure that the following requirements are fulfilled:

- IceMaker has been started for the first time. (see 4.2 Starting the IceMaker for the first time)



Fig. 28

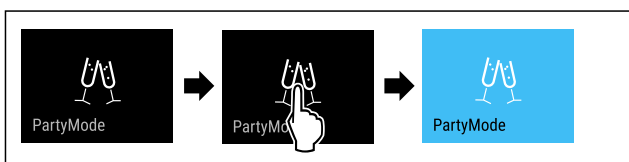

Fig. 29

- ▶ Carry out action steps according to the illustration.
- ▷ PartyMode and the corresponding functions are activated.
- ▷ Temperature display turns blue.
- ▷ The current temperature flashes until the target temperature is reached.

Deactivating PartyMode

PartyMode is automatically deactivated after 24 hours. However, you can also manually deactivate PartyMode at any time:

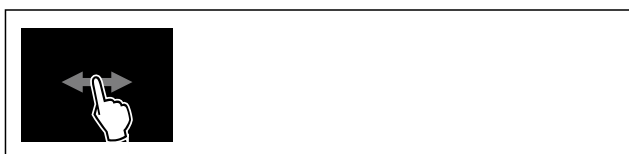

Fig. 30

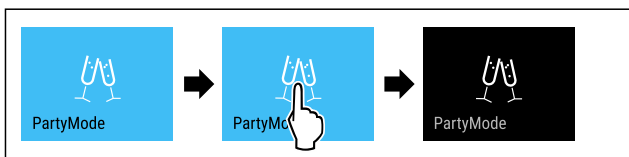

Fig. 31

- ▶ Carry out action steps according to the illustration.
- ▷ PartyMode is deactivated.
- ▷ The appliance first cools to the set temperature: The current temperature flashes until the target temperature is reached.



SabbathMode

This function activates and deactivates SabbathMode. If you activate this function, some electronic functions are switched off. Your appliance thereby meets the religious requirements of Jewish holidays such as the Sabbath and complies with STAR-K Kosher certification.

Appliance status with active SabbathMode
The status display continuously shows SabbathMode.
All functions in the display except the Deactivating SabbathMode function are disabled.
Active functions remain active.
The display remains bright when you close the door.
The interior lighting is deactivated.
Memories are not listed. The set time interval is stopped.
Memories and warnings are not displayed.
There is no door alarm.
There is no temperature alarm.
The IceMaker is out of order.
The defrost cycle operates only for the specified time without taking into account the appliance usage.
After a power failure, the device returns to SabbathMode.

Appliance status

Note

This appliance has certification from the "Institute for Science and Halacha". (www.machonhalacha.co.il)

You can find a list of STAR-K-certified appliances at www.star-k.org/appliances.

Use

Activating SabbathMode



WARNING

Danger of poisoning from spoiled food!

If you have SabbathMode activated and a power failure occurs, no message appears in the status display about the power failure. Once the power is restored, the appliance continues to operate in SabbathMode. The power failure may mean that food spoils and the consumption of this food could lead to food poisoning. After a power failure:

- ▶ Do not consume food that has been frozen and thawed.

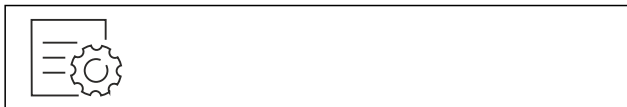

Fig. 32



Fig. 33

- ▶ Carry out action steps according to the illustration.
- ▷ SabbathMode is activated.
- ▷ Status display continuously shows SabbathMode.

Deactivating SabbathMode

SabbathMode is automatically deactivated after 80 hours. However, you can also manually deactivate SabbathMode at any time:

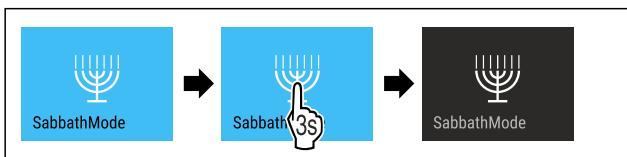

Fig. 34

- ▶ Carry out action steps according to the illustration.
- ▷ SabbathMode is deactivated.



EnergySaver

Use this function to activate or deactivate energy saving mode. If you activate energy saving mode, energy consumption drops and the temperature in the appliance increases. Food remains fresh, but shelf life is reduced.

Temperature zone	Recommended setting (see Setting the temperature)	Temperature while EnergySaver is active
-18°C	-18 °C (-0 °F)	-16 °C (3 °F)

Temperatures

Activating EnergySaver



Fig. 35

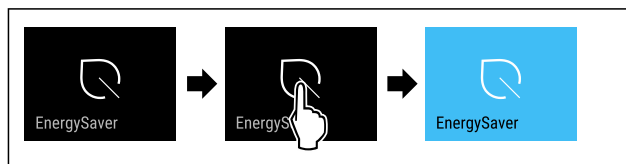

Fig. 36

- ▶ Carry out action steps according to the illustration.
- ▷ Energy saving mode is activated.

Deactivating EnergySaver



Fig. 37

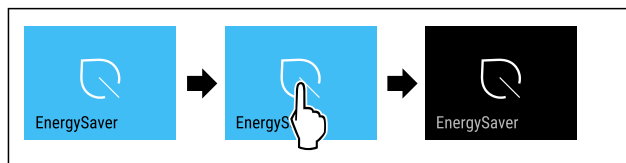

Fig. 38

- ▶ Carry out action steps according to the illustration.
- ▷ Energy saving mode is deactivated.



IceMaker / MaxIce

You can activate or deactivate ice cube production with the IceMaker function. Use the MaxIce function to increase the number of ice cubes in the IceMaker.

More information on the number of ice cubes:	(see 10.1 Technical specifications)
More information on the IceMaker water inflow:	(see IceMaker water inflow)
More information on cleaning the lines of the IceMaker:	(see TubeClean)

If the function is active, the appliance operates at a higher output. As a result, the operating noise of the appliance may be temporarily louder, while energy consumption increases.

Activating IceMaker

Make sure that the following requirements are fulfilled:

- The water supply is established at the fixed water connection. See Assembly Manual.
- IceMaker is put into operation. (see 8.4 IceMaker)



Fig. 39

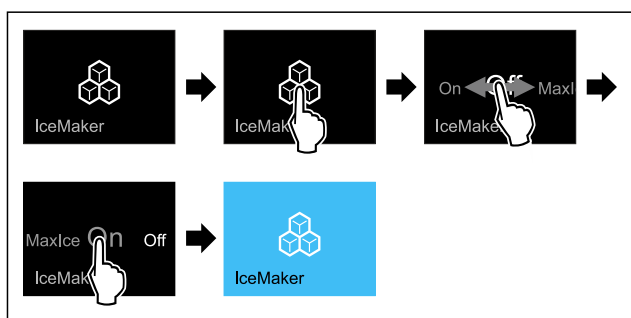

Fig. 40

- ▶ Carry out action steps according to the illustration.
- or-
- ▶ Activate with the SmartDevice app.

▷ IceMaker is activated. It can take up to 24 hours for the IceMaker to produce the first ice cubes.

Activating the IceMaker with MaxIce

If you have not activated the IceMaker function before, make sure that the following requirements are met:

- The water supply is established at the fixed water connection. See Assembly Manual.
- IceMaker is put into operation. (see 8.4 IceMaker)



Fig. 41

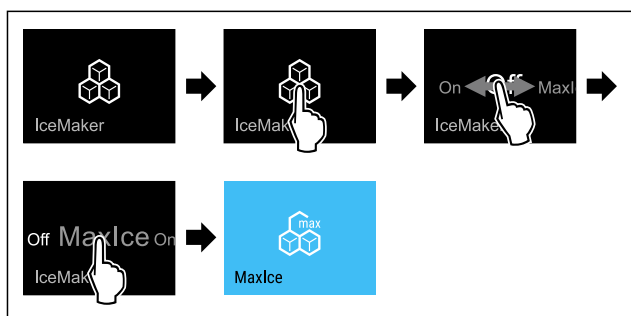

- Fig. 42
- ▶ Carry out action steps according to the illustration.
 - or-
 - ▶ Activate with the SmartDevice app.
- ▷ The IceMaker is activated with MaxIce.

Changing between the IceMaker and MaxIce

If you have activated IceMaker and would like to change to MaxIce:



Fig. 43

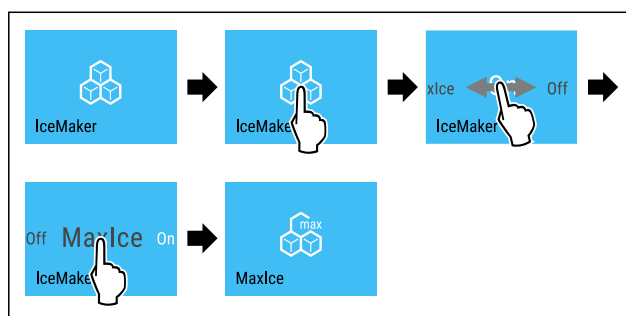

Fig. 44

- ▶ Carry out action steps according to the illustration.
- ▷ The IceMaker is activated with MaxIce.

If you have activated MaxIce and would like to change to IceMaker:



Fig. 45

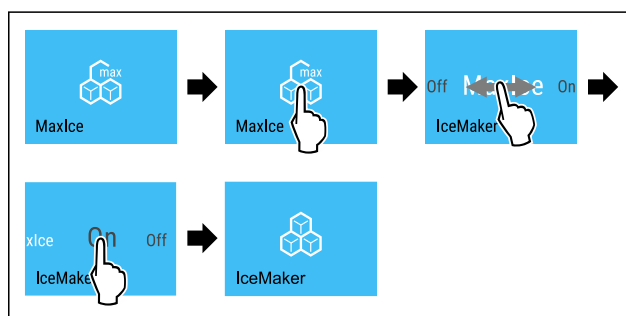

Fig. 46

- ▶ Carry out action steps according to the illustration.
- ▷ IceMaker is activated.
- ▷ MaxIce is deactivated.

Use

Deactivating the IceMaker / MaxIce



Fig. 47

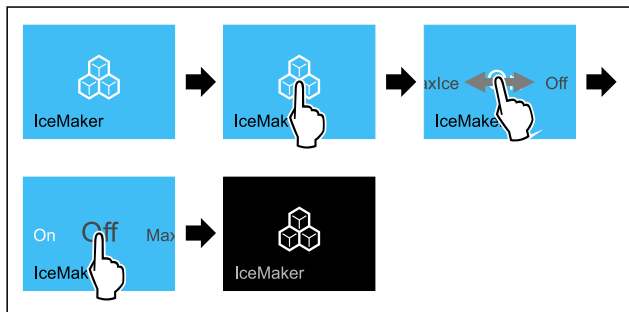

Fig. 48 Example illustration of the active IceMaker function

- ▶ Carry out action steps according to the illustration.
- or-
- ▶ Deactivate with the SmartDevice app.
- ▷ IceMaker and MaxIce are deactivated.
- ▷ If ice cubes are currently being made, the system completes the process.
- ▷ The IceMaker goes off automatically.

5

IceMaker water inflow

Use this function to set the IceMaker water inflow. The IceMaker water inflow regulates the water inflow volume. You can adjust the IceMaker water inflow if the water inflow does not match the water pressure and the dispensed ice cube size.

Upon delivery, the IceMaker water inflow is set to the value 5. You can select a value of between 1 (smallest inflow volume) and 8 (largest inflow volume).

Setting the IceMaker-water inflow

Make sure that the following requirements are fulfilled:

- IceMaker has been started for the first time. (see 4.2 Starting the IceMaker for the first time)
- IceMaker is activated. (see IceMaker / MaxIce)

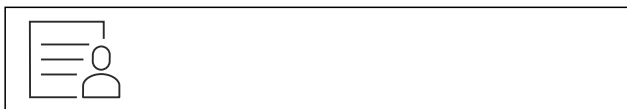

Fig. 49

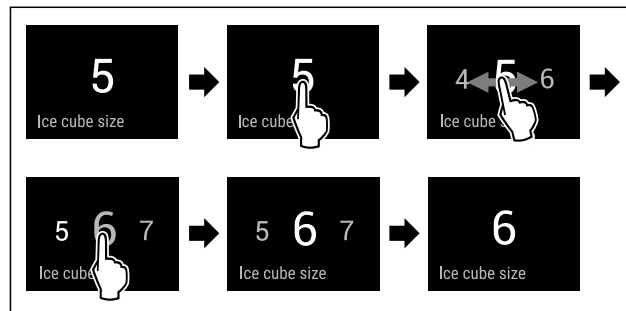

Fig. 50 Example illustration: Switching from value 5 to value 6.

- ▶ Carry out action steps according to the illustration.
- ▷ IceMaker water inflow is set.



TubeClean

This function activates or deactivates TubeClean. Activating TubeClean cleans the IceMaker lines.

Activating TubeClean

Make sure that the following requirements are fulfilled:

- IceMaker cleaning is prepared. (see 9.3.5 Cleaning the IceMaker)
- Empty container with a capacity of 1.5 l (1.59 qt) and with a maximum height of 10 cm (3 15/16 in) is ready.
- ▶ Place the container into the drawer below the IceMaker.



Fig. 51

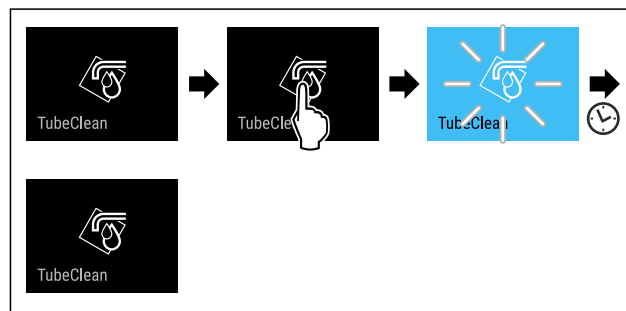

Fig. 52

- ▶ Carry out action steps according to the illustration.
- ▷ TubeClean is activated.
- ▷ Cleaning process has started: Symbol flashes until the cleaning process is automatically completed after 60 minutes.
- ▷ When the cleaning process is completed: Appliance continues to run in normal operation.

Deactivating TubeClean

TubeClean is automatically completed after 60 minutes. However, you can also deactivate TubeClean at any time during the cleaning process:

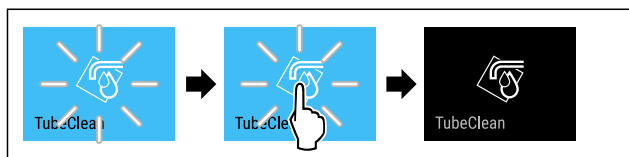

Fig. 53

- ▶ Carry out action steps according to the illustration.
- ▷ TubeClean is deactivated: Cleaning process is canceled.
- ▷ Appliance continues to run in normal operation.

Display Brightness

Use this function to set the brightness of the display gradually.

You can set the following brightness levels:

- 40 %
- 60 %
- 80 %
- 100% (default setting)

Setting the brightness



Fig. 54

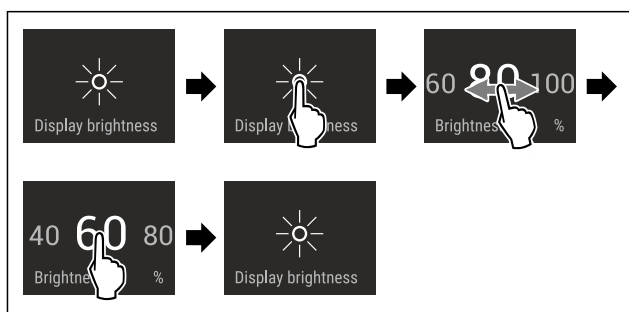

Fig. 55 Example illustration: Switching from 80 % to 60 %.

- ▶ Carry out action steps according to the illustration.
- ▷ Brightness is set.

Door alarm

Use this function to activate or deactivate the door alarm. The door alarm sounds if the door is open for too long. The door alarm is activated upon delivery. You can set how long the door can remain open until the door alarm sounds.

You can set the following values:

- 1 minute
- 2 minutes
- 3 minutes
- Off

Setting the door alarm



Fig. 56

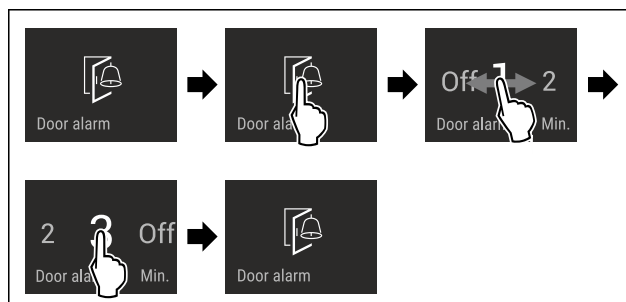

Fig. 57 Example illustration: Changing the door alarm from 1 minute to 3 minutes.

- ▶ Carry out action steps according to the illustration.
- ▷ Door alarm is set.

Deactivating door alarm



Fig. 59

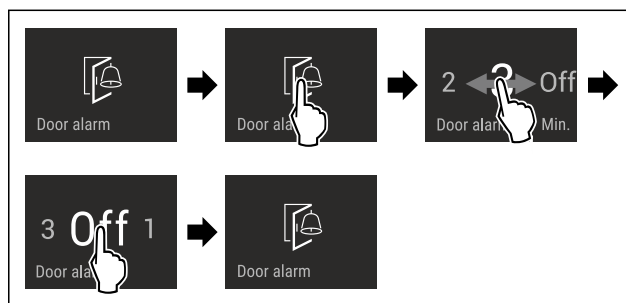

Fig. 60

- ▶ Carry out action steps according to the illustration.
- ▷ Door alarm is deactivated.

Input lock

This function activates and deactivates the input lock. The input lock prevents the appliance from being operated accidentally, e. g. by children.

Application:

- Prevent unintentional changes of functions.
- Prevent switching off of the appliance.
- Prevent unintentional temperature setting.

Activating the input lock

If you activate the input lock, you can continue to navigate in the menus, however you cannot select or modify other functions.

Use



Fig. 61

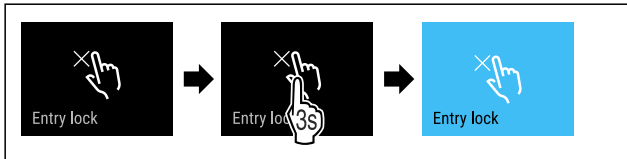

Fig. 62

- ▶ Carry out action steps according to the illustration.
- ▷ Input lock is activated.

Deactivating the input lock



Fig. 63

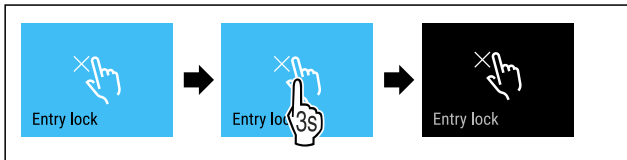

Fig. 64

- ▶ Carry out action steps according to the illustration.
- ▷ Input lock is deactivated.

Language

Use this function to set the display language.

You can set the following languages:

- German
- English
- French
- Spanish
- Italian
- Dutch
- Czech
- Polish
- Portuguese
- Bulgarian
- Russian
- Chinese

Setting the language



Fig. 65

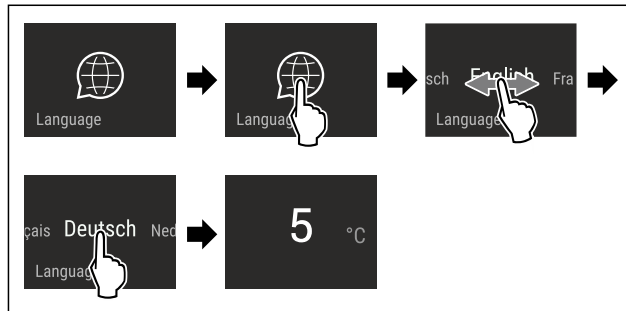

Fig. 66 Example illustration depending on the language and temperature

- ▶ Carry out action steps according to the illustration.
- ▷ Language is set.
- ▷ Display jumps back to the status display.

Appliance information

Use this function to display the model name, index, serial number and service number of your appliance. You will need the appliance information when you contact customer service. (see 10.4 Customer Service)
You also use this function to open the expanded menu. (see 3 Functionality of the Touch & Swipe display)

Display appliance information



Fig. 67



Fig. 68

- ▶ Carry out action steps according to the illustration.
- ▷ Display shows the appliance information.

Software

Use this function to display the software version of your appliance.

Display software version

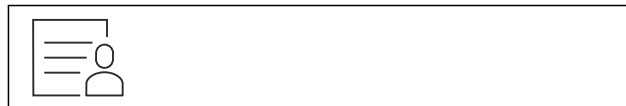

Fig. 69



Fig. 70

- ▶ Carry out action steps according to the illustration.
- ▷ Display indicates the software version.

Reminder

Use this function to activate or deactivate reminder. This function is activated upon delivery.

Activating reminder



Fig. 71

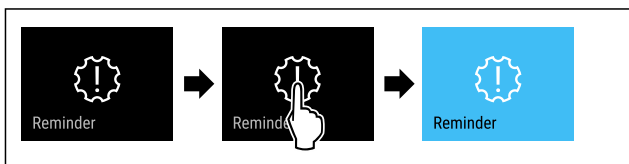

Fig. 72

- ▶ Carry out action steps according to the illustration.
- ▷ Reminder is activated.

Deactivating reminder

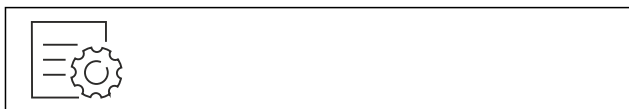

Fig. 73

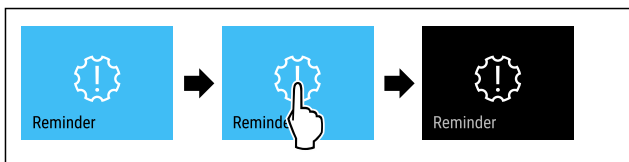

Fig. 74

- ▶ Carry out action steps according to the illustration.
- ▷ Reminder is deactivated.

Demo mode

Demo mode is a special feature for dealers who want to demonstrate appliance features. If you activate demo mode, all refrigeration functions are deactivated. If you switch on your appliance and “Demo” appears in the status display, then demo mode is already activated.

If you activate and then deactivate demo mode, the appliance will be reset to factory defaults. (see Resetting to factory settings)

Activating demo mode



Fig. 75

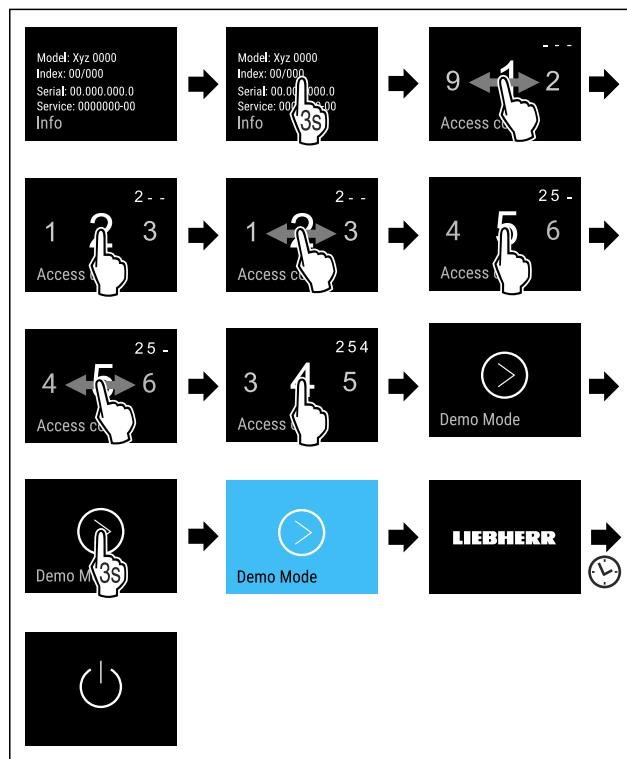

Fig. 76

- ▶ Carry out action steps according to the illustration.
- ▷ Demo mode is activated.
- ▷ Appliance is switched off.
- ▶ Switch on the appliance. (see 4.1 Switching on appliance (first use))
- ▷ “DEMO” appears in the status display.

Deactivating demo mode



Fig. 77

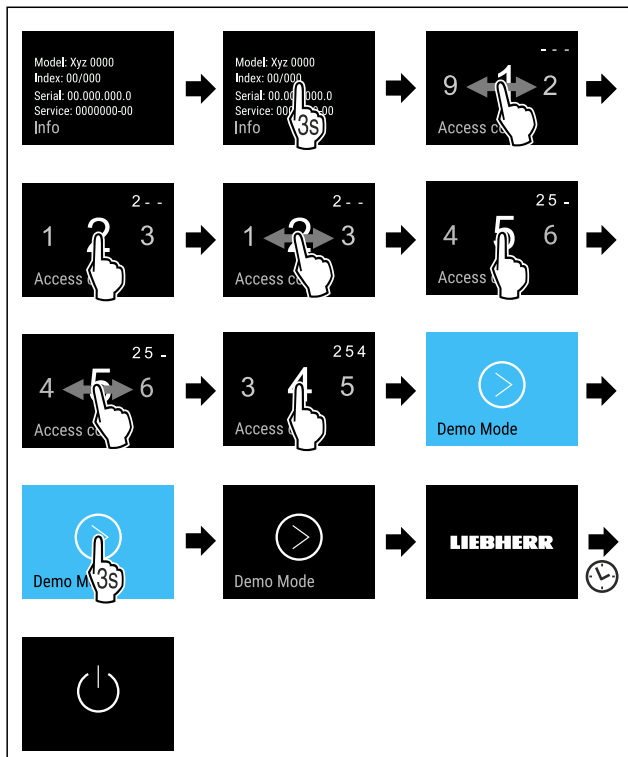

Fig. 78

- ▶ Carry out action steps according to the illustration.
- ▷ Demo mode is deactivated.
- ▷ Appliance is switched off.
- ▶ Switch on the appliance. (see 4.1 Switching on appliance (first use))
- ▷ Appliance is reset to factory settings.

Resetting to factory settings

Use this function to reset all settings to factory settings. All settings you have made so far are reset to their original settings.

Performing a reset



Fig. 79

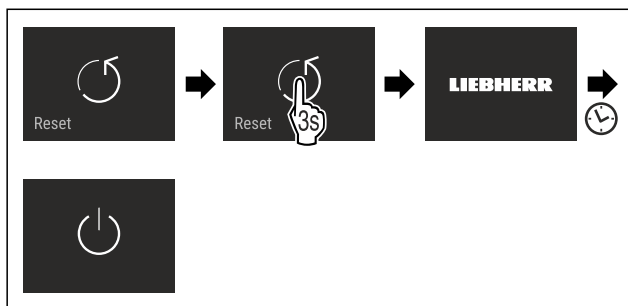

Fig. 80

- ▶ Carry out action steps according to the illustration.

- ▷ Appliance is reset.
- ▷ Appliance is switched off.
- ▶ Restart the appliance. (see 4.1 Switching on appliance (first use))

7.3 Messages



There are two categories of messages:

Category	Meaning
Warning	Warnings are displayed if there is a door alarm or a malfunction. You can easily end warnings yourself. For any major malfunction, you must contact Customer Service. (see 10.4 Customer Service)
Reminder	Reminders remind you of general processes. You can perform these processes and end the message doing so.

7.3.1 Overview of warnings

The appliance's behavior in the event of a warning:

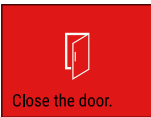
- Warning appears in the display in red.
- Alarm sounds in increasing volume.
- For some warnings the interior lighting pulses.

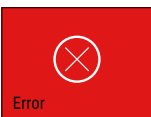
Message	Cause	Ending the message
 Close the door. Door alarm	The message appears if the door is open for too long.	Carry out action steps (see Door alarm).
 Power failure Power failure alarm	The message appears if the freezing temperature increases due to a power outage.	Carry out action steps (see Power failure alarm).
 Temperature alarm Temperature alarm	The message appears if the freezing temperature does not correspond to the set temperature.	Carry out action steps (see Temperature alarm).
 Error Error	This message appears if there is an appliance error. An appliance module indicates an error.	Carry out action steps (see Error).

Message	Cause	Ending the message
 WLAN error	This message appears if the appliance could not be connected to the WLAN. (see Establishing the WiFi connection for the first time)	Carry out action steps (see WLAN error).

7.3.2 Ending warnings

Door alarm

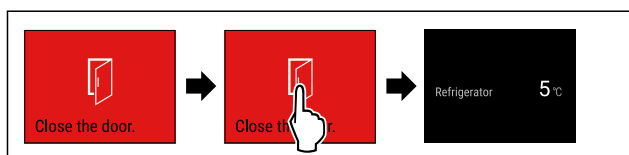

Fig. 81 Example illustration

- ▶ Carry out action steps according to the illustration.

-or-

- ▶ Close the door.

- ▷ Display skips to status display.

You can set how long the door may remain open until the door alarm sounds. (see Setting the door alarm)

Power failure alarm

Once the power failure has ended, the appliance cools to the target temperature set earlier.

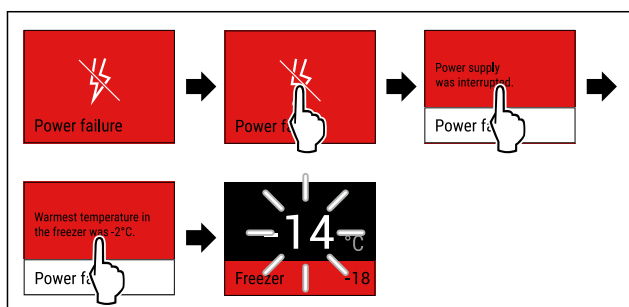

Fig. 82 Example illustration

- ▶ Briefly touch the display.
- ▷ Display shows information about the warning.
- ▶ Briefly touch the display.
- ▷ The warmest freezing temperature is displayed.
- ▷ If the freezing temperature was below -9 °C (16 °F): Food can still be eaten.
- If the freezing temperature exceeded -9 °C (16 °F):
- ▶ Check the food.
- ▶ Briefly touch the display.
- ▷ Display skips to status display: The current temperature and target temperature are displayed.

Temperature alarm

Causes for the temperature differences may be:

- You have put in warm, fresh food.

- Too much warm room air has flowed in during the rearrangement and removal of food.
- The power has been out for a longer period of time.
- The appliance is defective.

- ▶ Remedy the cause.

- ▷ The appliance cools to the target temperature set earlier:

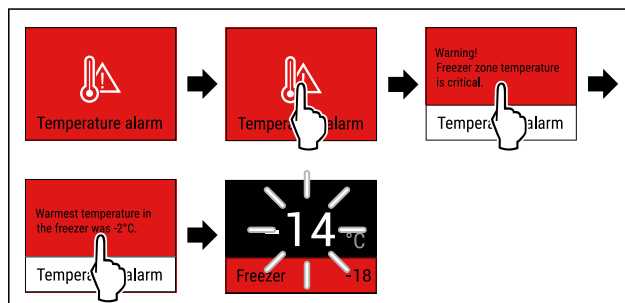

Fig. 83 Example illustration

- ▶ Briefly touch the display.
- ▷ Display shows information about the warning.
- ▶ Briefly touch the display.
- ▷ The warmest freezing temperature is displayed.
- ▷ If the freezing temperature was below -9 °C (16 °F): Food can still be eaten.
- If the freezing temperature exceeded -9 °C (16 °F):
- ▶ Check the food.
- ▶ Briefly touch the display.
- ▷ Display skips to status display: The current temperature and target temperature are displayed.

Error

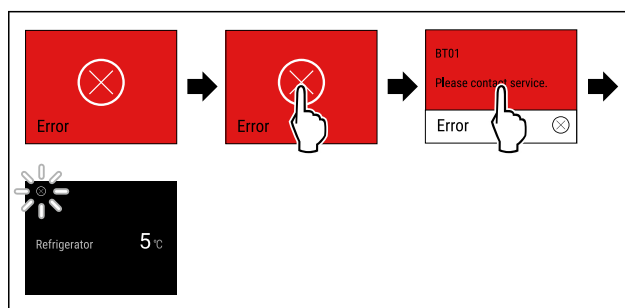

Fig. 84 Example illustration

- ▶ Briefly touch the display.
- ▷ Error code is displayed.
- ▶ Make a note of the error code.
- ▶ Briefly touch the display.
- ▷ Display skips to status display.
- ▶ Contact Customer Service. (see 10.4 Customer Service)

WLAN error

- ▶ Check the WLAN connection.
- ▶ Connect the appliance to the WLAN again. (see WiFi)

7.3.3 Overview of reminders

The appliance's behavior in the event of a reminders:

- Reminder appears in the display in yellow.

Equipment

- Alarm tone sounds.
- For some reminders the interior lighting pulses.

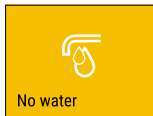
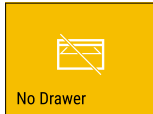
Message	Cause	Ending the message
 <p>Check water connection</p>	This message appears if the IceMaker is active, but the IceMaker is no longer being supplied with water by a permanent water connection.	Carry out action steps (see Check water connection).
 <p>Push in the IceMaker drawer</p>	This message appears if the IceMaker is active, but the IceMaker drawer is open.	Carry out action steps (see Push in the IceMaker drawer).

7.3.4 Ending reminders

Check water connection

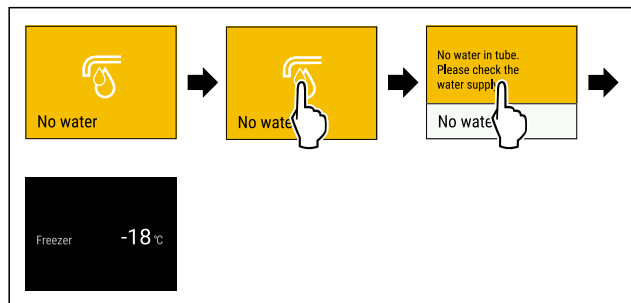

Fig. 85 Example illustration

- ▶ Briefly touch the display
- ▷ Display shows information about the reminder.
- ▶ Briefly touch the display
- ▶ Check the water connection.

-or-

- ▶ Deactivate IceMaker. (see Deactivating the IceMaker / MaxIce)

If the water connection has been checked and IceMaker is activated:

- ▶ Clean the IceMaker. (see 9.3.5 Cleaning the IceMaker)
- ▷ IceMaker is producing ice cubes.

Push in the IceMaker drawer

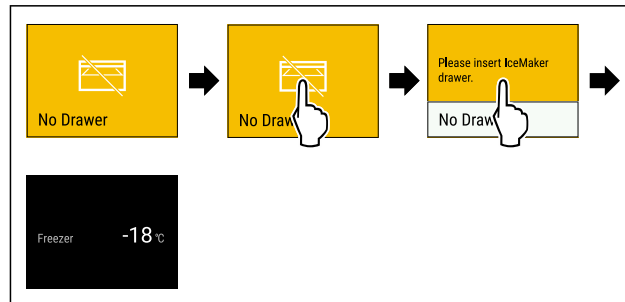

Fig. 86 Example illustration

- ▶ Briefly touch the display.
 - ▷ Display shows information about the reminder.
 - ▶ Briefly touch the display.
 - ▶ Push in the IceMaker drawer.
- or-
- ▶ Deactivate IceMaker. (see IceMaker / MaxIce)
- ▷ If the IceMaker drawer is pushed in and IceMaker is active: IceMaker is producing ice cubes.

8 Equipment

8.1 Drawers

You can remove the drawers for cleaning.

You can remove the drawers to use VarioSpace.

The way to remove/insert the drawers varies depending on the pull-out system. Your appliance can contain a variety of pull-out systems.

Note

Insufficient ventilation results in an increase in energy consumption and reduction of the refrigerating performance.

- ▶ Leave the bottom drawer in appliance!
- ▶ Never obstruct the vents on the interior rear wall!

8.1.1 Drawer on telescopic rails

The drawer runs on full-extension rails (telescopic rails). There are full-extension telescopic rails and telescopic rails with partial pull-out. Drawers which are full extension can be pulled out fully from the appliance. Drawers with partial pull-out cannot be pulled out fully from the appliance. The system in your appliance depends on the type of appliance.

Drawer on glass shelf

The drawer guided on a glass shelf is a partial pull-out.

Removing drawer

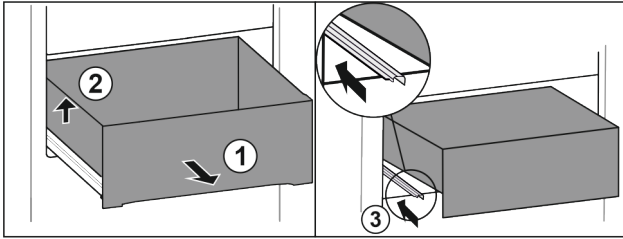

Fig. 87

- ▶ Pull out drawer as far as it will go. Fig. 87 (1)
- ▶ Lift drawer on the left. Fig. 87 (2)
- ▶ Slide in left rail. Fig. 87 (3)

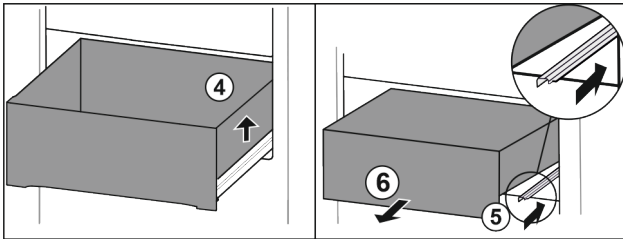

Fig. 88

- ▶ Lift drawer on the right. Fig. 88 (4)
- ▶ Slide in right rail. Fig. 88 (5)
- ▶ Remove drawer to the front. Fig. 88 (6)

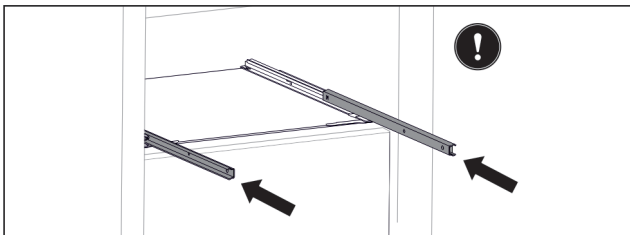

Fig. 89

If the rails are not yet fully pushed in after removing the drawer:

- ▶ Push the rails in completely.

Inserting drawer

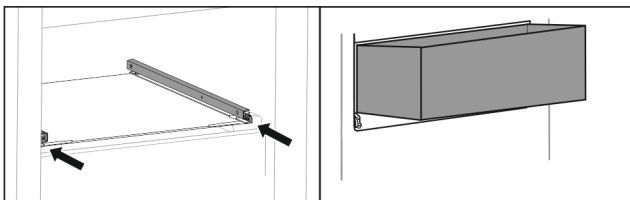

Fig. 90

- ▶ Slide rails in.
- ▶ Place drawer on rails at an angle.

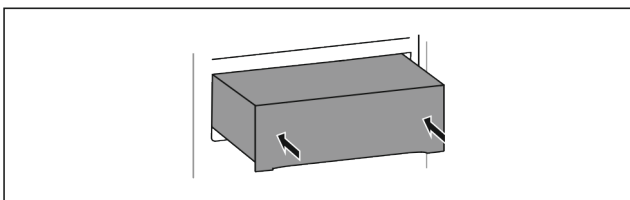

Fig. 91

- ▶ Lower drawer.
- ▶ Slide in drawer to the back.

8.1.2 Top tilting drawer

When you pull out the top drawer, it tilts forward. This gives you a better view into the drawer. The function depends on the height of the appliance.

Removing drawer

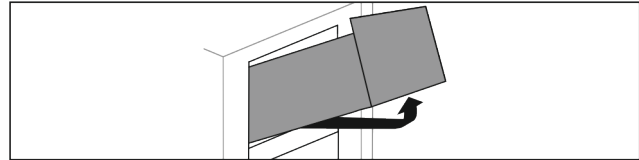

Fig. 92

- ▶ Pull out drawer as far as it will go.
- ▶ Lift drawer at the front.
- ▶ Lift drawer from below.
- ▶ Remove drawer to the front.

Inserting drawer

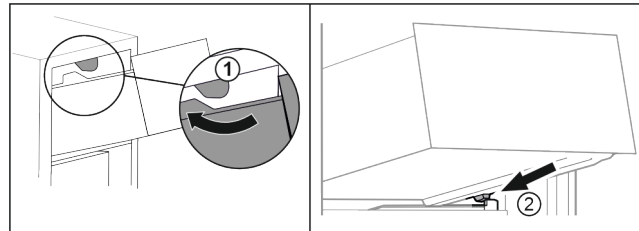

Fig. 93

- ▶ Guide drawer around the upper stoppers. Fig. 93 (1)
- ▶ Place drawer at an angle behind the lower stoppers on the molded rib. Fig. 93 (2)
- ▶ Lower drawer.
- ▶ Slide to the rear.

8.1.3 Bottom drawer

The drawer is the lowest drawer in the appliance. It runs directly on the molded rib. There are no rails.

Removing drawer

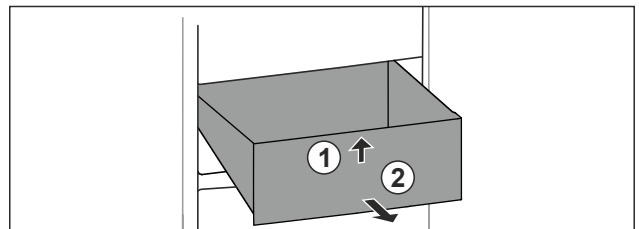

Fig. 94

- ▶ Pull out drawer as far as it will go.
- ▶ Lift up drawer at the front. Fig. 94 (1)
- ▶ Remove drawer to the front. Fig. 94 (2)

Equipment

Inserting drawer

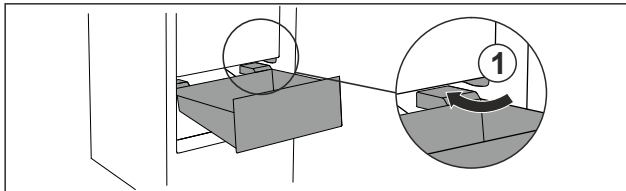

Fig. 95

- ▶ Guide drawer in at an angle around the stoppers Fig. 95 (1).
- ▶ Lower the drawer.
- ▶ Slide in drawer to the back.

8.2 Pull-out board with IceTower

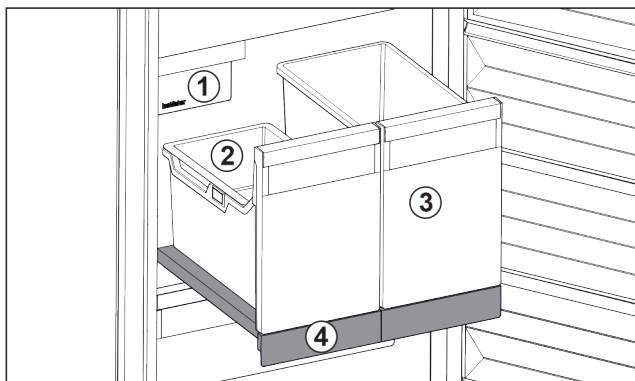

Fig. 96 Pull-out board with IceTower

- (1) IceMaker
- (2) Hang-on tray for ice cubes
- (3) Container for pizza or alcoholic beverages, for example
- (4) Pull-out board

On the pull-out board are two tall containers (IceTower). Ice cubes from the IceMaker are collected and stored in the container Fig. 96 (2). The container Fig. 96 (3) is suitable for storing tall foodstuffs or beverages such as pizzas or alcoholic drinks.

The pull-out board with IceTower is mounted on a glass shelf with pull-out rails. You can dismantle the pull-out board for cleaning.

8.2.1 Dismantling the pull-out board with IceTower

Removing the container

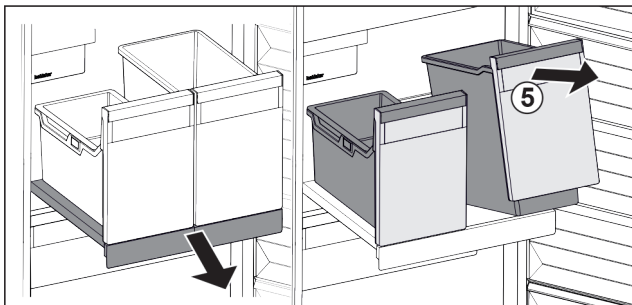

Fig. 97

- ▶ Remove the pull-out board.
- ▶ Lift the container Fig. 97 (5) at the front.
- ▶ Remove the container.

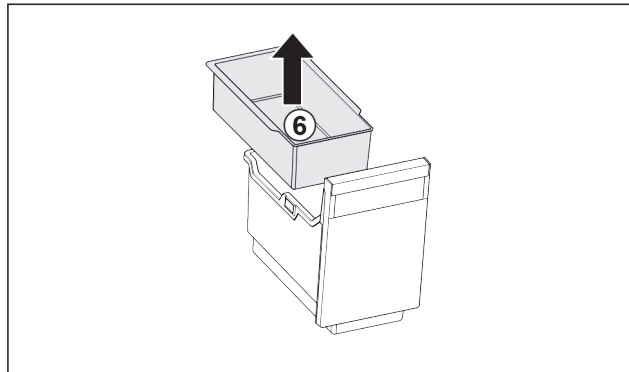

Fig. 98

- ▶ Remove the hang-on tray Fig. 98 (6).
- ▶ If there are ice cubes in the hang-on tray: Empty the hang-on tray.
- ▷ The container and hang-on tray have been removed and you can clean them. (see 9.3.4 Cleaning the equipment)

Removing the pull-out board

Make sure that the following requirements are fulfilled:

- Containers have been removed. (see Removing the container)

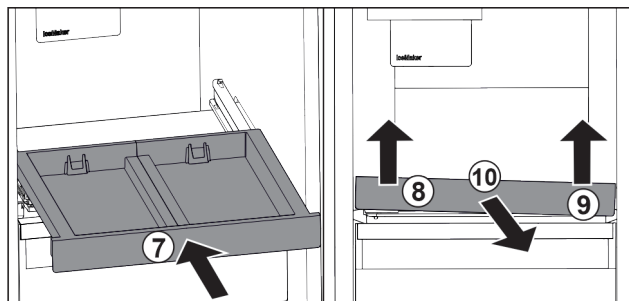

Fig. 99

- ▶ Slide in the pull-out board. Fig. 99 (7)
- ▶ Lift the pull-out board at the front left. Fig. 99 (8)
- ▶ Lift the pull-out board at the front right. Fig. 99 (9)
- ▷ The pull-out board is detached from the attachment at the front.
- ▶ Take out the pull-out board to the front. Fig. 99 (10)
- ▷ The pull-out board has been removed and you can clean it. (see 9.3.4 Cleaning the equipment)

Removing the glass shelf from under the pull-out board

(see 8.3 Glass shelves)

8.2.2 Inserting the pull-out board with IceTower

Inserting the glass shelf under the pull-out board

(see 8.3 Glass shelves)

Inserting the pull-out board

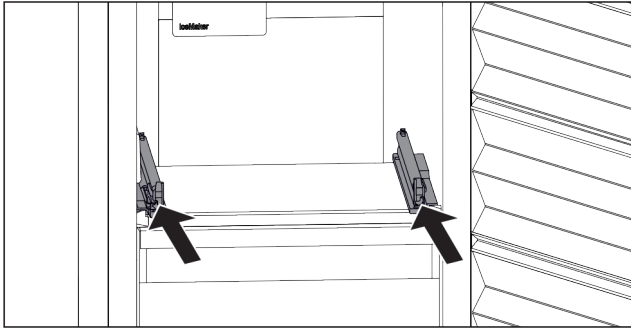

Fig. 100

- ▶ Slide the rails in.

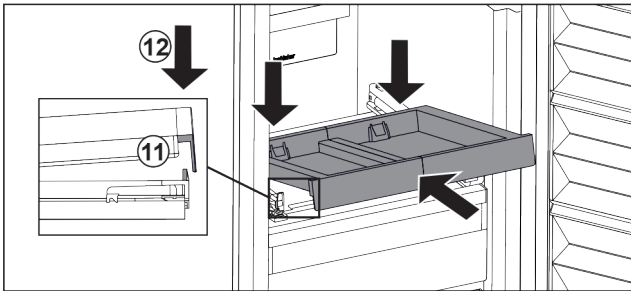

Fig. 101

- ▶ Place the pull-out board in at an angle behind the front lug.
- ▶ Slide it in at an angle. Make sure that the stop is behind the lug on both sides. *Fig. 101 (11)*
- ▶ Lower the pull-out board at the front. *Fig. 101 (12)*

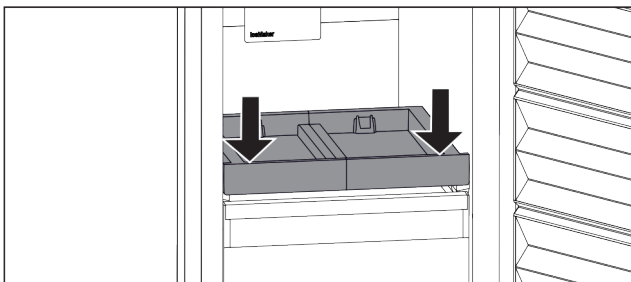

Fig. 102

- ▶ Push the pull-out board down at the front.
- ▷ The pull-out board clicks into place.

Inserting the container

Make sure that the following requirements are fulfilled:

- ☐ The pull-out board is inserted. (see Inserting the pull-out board)

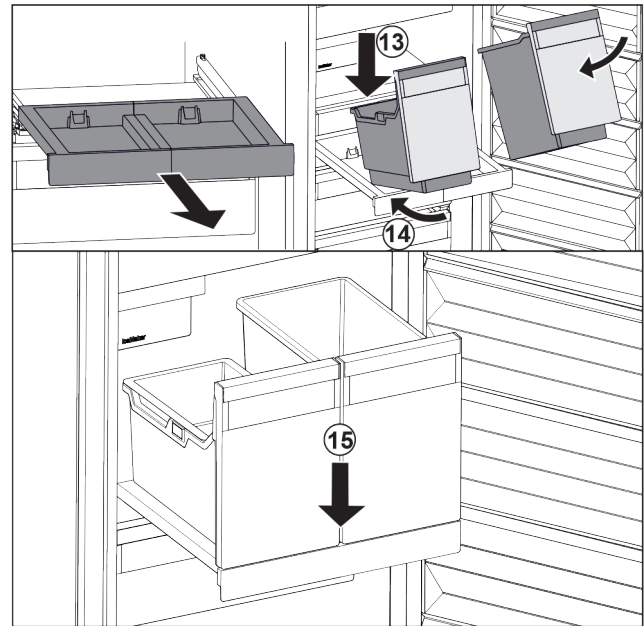

Fig. 103

- ▶ Remove the pull-out board.
- ▶ Hold the pull-out board with one hand.

Note

The containers are shaped in a way that they cannot be interchanged.

- ▶ Place the container at an angle on the pull-out board. *Fig. 103 (13)*
- ▶ Slide in the container at an angle to the back. *Fig. 103 (14)*
- ▶ Place container at the front. *Fig. 103 (15)*

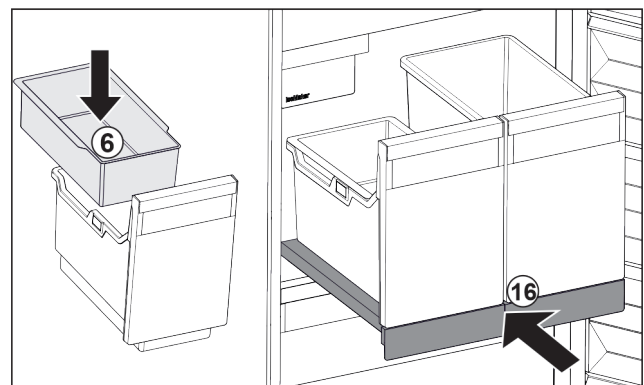

Fig. 104

- ▶ Insert hang-on tray *Fig. 104 (6)* for ice cubes.
- ▶ Slide in the pull-out board with container (IceTower). *Fig. 104 (16)*
- ▷ Pull-out board with IceTower is fully inserted.

Equipment

8.3 Glass shelves

NOTICE

Impermissible removal of the glass panel above the IceTower!

Damage to the IceMaker. The IceMaker is attached to the glass panel above the IceTower.

▶ Do not remove the glass panel above the IceTower.

You can remove the glass shelf under the drawers for cleaning.

You can remove the glass shelf under the drawers to use VarioSpace.

8.3.1 Removing / inserting the glass shelf

Make sure that the following requirements are fulfilled:

- ❑ Glass shelf under the drawer: Drawer has been removed. (see 8.1 Drawers)
- ❑ Pull-out board under IceTower: IceTower has been removed. (see 8.2 Pull-out board with IceTower)

Removing glass shelf

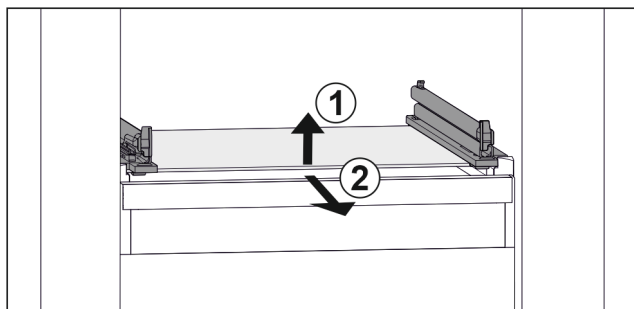

Fig. 105 Example illustration of glass shelf

- ▶ Lift glass shelf at the front. Fig. 105 (1)
- ▶ Remove glass shelf to the front. Fig. 105 (2)

Inserting the glass shelf

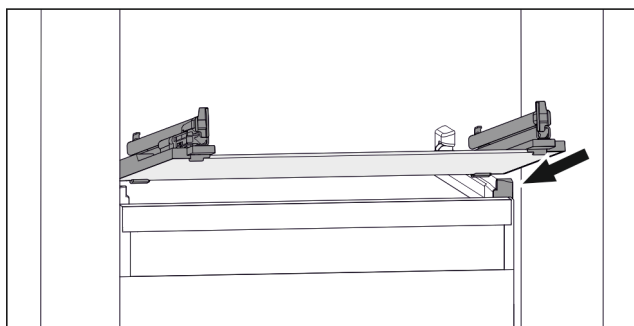

Fig. 106 Example illustration of glass shelf

- ▶ Position glass shelf at an angle behind the stoppers. (see Fig. 106)
- ▶ Lower glass shelf.
- ▶ Slide in glass shelf to the back.

8.4 IceMaker

The IceMaker is used exclusively for the production of ice cubes in household quantities.

Make sure that the following conditions are fulfilled

- IceMaker is cleaned. (see 9 Maintenance)
- IceMaker drawer is cleaned.
- IceMaker drawer is fully inserted.

8.4.1 Producing ice cubes

The production capacity depends on the freezer temperature. The lower the temperature, the more ice cubes can be produced in a certain period.

Once IceMaker is switched on for the first time, it can take up to 24 hours to produce the first ice cubes.

- ▶ Activate the IceMaker function.
- ▶ Making many ice cubes: Activate the MaxIce function.
- ▶ Distribute ice cubes evenly in the drawer to increase its capacity.
- ▶ Close the drawer: The IceMaker starts making ice again.

Note

When a certain level is reached in the IceMaker drawer, it stops making ice cubes. The IceMaker does not fill the drawer to the very top.

8.5 VarioSpace

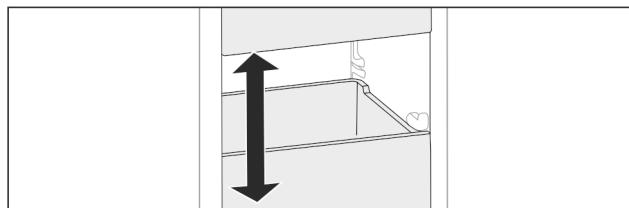

Fig. 107

You can remove drawers and glass panels from your appliance. This provides more room for large food items such as poultry, joints of meat, large game and bulky baked goods. You can then freeze these items whole for later preparation.

- ▶ Note the load limits on the drawers and glass panels (see 10.1 Technical specifications).

8.6 Freezer packs

The freezer packs prevent the temperature from rising too fast in the event of a power failure.

The freezer packs are in the drawer.

You can store the cold storage accumulators in the freezer tray.

8.6.1 Using the freezer packs

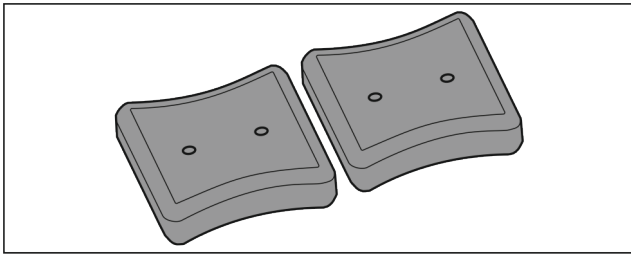

Fig. 108

When the freezer packs are fully frozen:

- ▶ Place on the frozen goods in the top, front part of the freezer.

9 Maintenance

9.1 Disassembling / assembling pull-out systems

9.1.1 Notes on disassembly

You can disassemble some of the pull-out systems for cleaning. Your appliance can contain a variety of pull-out systems.

The following pull-out systems can be disassembled or cannot be disassembled:

Pull-out system	can be disassembled / cannot be disassembled
Drawer guided on glass shelf	can be disassembled (see Drawer on glass shelf)
Top tiltable drawer	cannot be disassembled
	cannot be disassembled
Bottom drawer	cannot be disassembled
IceTower	can be disassembled (see 9.1.3 IceTower)

9.1.2 Drawer on telescopic rails

Drawer on glass shelf

Disassembling pull-out system

Make sure that the following requirements are fulfilled:

- Drawer has been removed.
- Glass shelf has been removed. (see 8.3 Glass shelves)

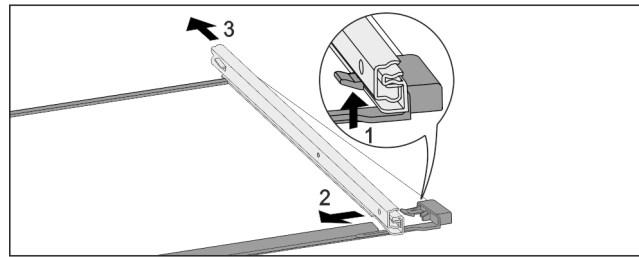

Fig. 109 Glass shelf with rails

- ▶ Push up front click-in hooks. (1)
- ▶ Slide pull-out rails to the side (2) and backwards (3).

Installing pull-out system

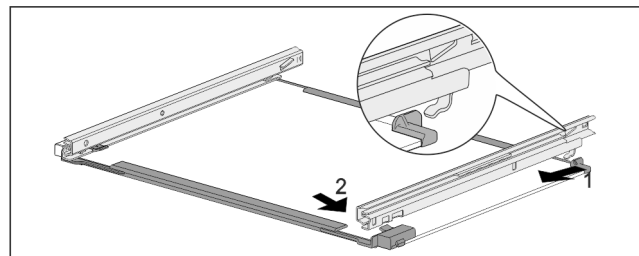

Fig. 110 Glass shelf with rails

- ▶ Hook in rail at the back. (1)
- ▶ Hook in rail at the front. (2)

9.1.3 IceTower

Disassembling pull-out system

Make sure that the following requirements are fulfilled:

- IceTower has been removed. (see 8.2 Pull-out board with IceTower)
- Glass shelf has been removed. (see 8.3 Glass shelves)
- ▶ Place pull-out board on a table.
- ▷ You are able to remove the rails more easily from the glass shelf.

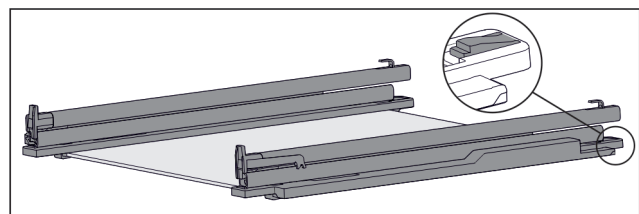

Fig. 111 Glass shelf with rails and retaining parts

- ▶ Press down retaining part at the rear (see Fig. 111) and simultaneously push rail back.

Maintenance

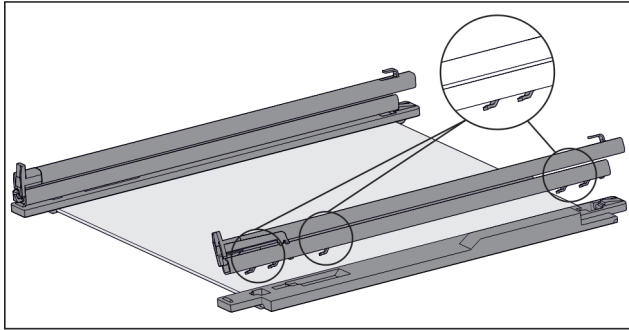

Fig. 112 Glass shelf with rails and retaining parts

- ▷ The rail hooks are released from the retaining part.
- ▶ Remove rail from retaining part.

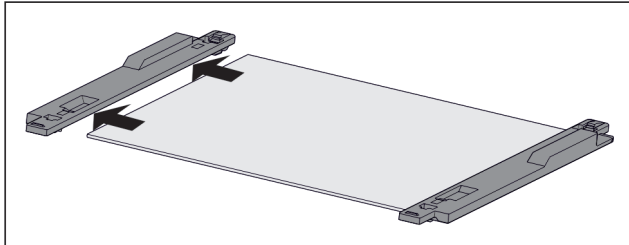

Fig. 113 Glass shelf with retaining part

- ▶ Remove retaining part from glass shelf sideways.

Installing pull-out system

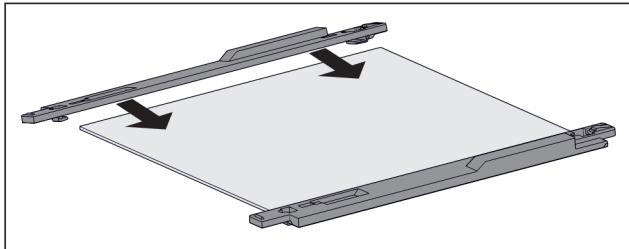

Fig. 114 Glass shelf with retaining part

- ▶ Fit retaining part on glass shelf.
- ▶ Push retaining part onto glass shelf as far as it will go.

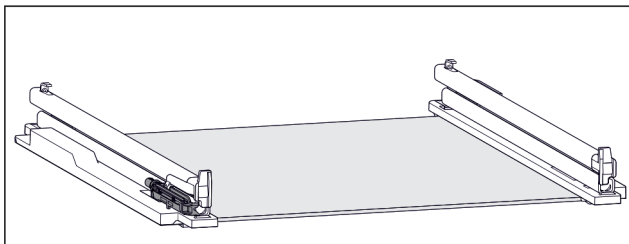

Fig. 115 Damping mechanism

The damping mechanism is attached to the left rail. (see Fig. 115) There is no damping mechanism attached to the right rail.

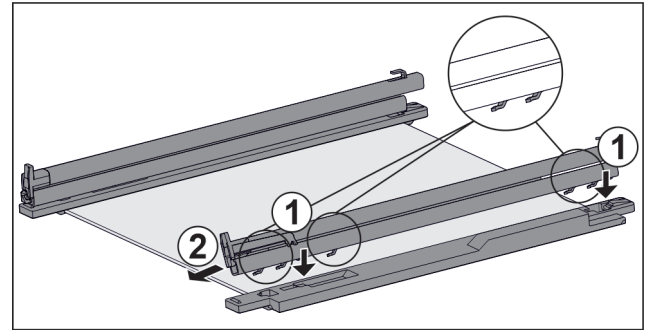

Fig. 116 Glass shelf with rails and retaining parts

Install rail **with** damping mechanism:

- ▶ Place rail hooks onto the openings of the **left** retaining part. Fig. 116 (1)
- ▶ Push rail forwards. Fig. 116 (2)
- ▷ Rail latches in audibly.

Install rail **without** damping mechanism:

- ▶ Place rail hooks onto the openings of the **right** retaining part. Fig. 116 (1)
- ▶ Push rail forwards. Fig. 116 (2)
- ▷ Rail latches in audibly.

9.2 Defrosting the appliance

9.2.1 Defrosting with NoFrost

Defrosting is performed automatically by the NoFrost system. The moisture condenses on the evaporator and is periodically defrosted and evaporated.

The appliance does not need to be defrosted.

Note

Water droplets may collect on the bottom of the appliance.

When you decommission the appliance:

- ▶ Place a towel in front of the appliance to catch any water that might drip out. (see 11 Decommissioning)

9.3 Cleaning the appliance

9.3.1 Preparation



WARNING

Danger of electric shock.

- ▶ Unplug refrigerator or disconnect power.



WARNING

Danger of fire

- ▶ Do not damage the refrigerant circuit.

- ▶ Empty appliance.
- ▶ Pull out the power plug.

9.3.2 Cleaning the housing

NOTICE

Improper cleaning!
Damage to the appliance.

- ▶ Only use soft cleaning cloths and ph-neutral all-purpose cleaners.
- ▶ Do not use steel wool or sponges that scour or scratch.
- ▶ Do not use caustic or abrasive cleaning materials or those containing sand, chloride, or acids.



WARNING

Risk of injury or damage due to hot steam.
Hot steam can cause scalding/burns and damage to surfaces.

- ▶ Do not use steam cleaners.
- ▶ Wipe the housing down with soft, clean cloth. If very dirty, use lukewarm water with a neutral cleaner. Glass surfaces can also be cleaned with glass cleaner.

9.3.3 Cleaning the interior

NOTICE

Improper cleaning!
Damage to the appliance.

- ▶ Only use soft cleaning cloths and ph-neutral all-purpose cleaners.
- ▶ Do not use steel wool or sponges that scour or scratch.
- ▶ Do not use caustic or abrasive cleaning materials or those containing sand, chloride, or acids.
- ▶ Plastic surfaces: clean by hand with a soft clean cloth, lukewarm water and a little detergent.
- ▶ Metal surfaces: clean by hand with a soft clean cloth, lukewarm water and a little detergent.

9.3.4 Cleaning the equipment

NOTICE

Improper cleaning!
Damage to the appliance.

- ▶ Only use soft cleaning cloths and ph-neutral all-purpose cleaners.
- ▶ Do not use steel wool or sponges that scour or scratch.
- ▶ Do not use caustic or abrasive cleaning materials or those containing sand, chloride, or acids.

Clean with a soft, clean cloth, lukewarm water and a little washing up liquid:

- IceTower pull-out board
- Drawer
Please note: Do not remove the magnet on the drawer. The magnet ensures that the IceMaker functions.
- Freezer tray

Clean with a damp cloth:

- Retracting rails
Please note: the grease in the tracks is there for lubrication purposes and must not be removed!

Clean in the dishwasher up to 60 °C (140 °F):

- Ice cube scoop
- FlexCube
- ▶ Disassemble the equipment: see the relevant section.
- ▶ Clean the equipment.

9.3.5 Cleaning the IceMaker

There are various options for cleaning the IceMaker.

We recommend cleaning in the following situations:

- Initial commissioning
- With water connection:
If out of use for longer than 5 days.

Make sure that the following requirements are met:

- IceMaker drawer is emptied.
- IceMaker drawer is fully inserted.
- The IceMaker has been activated.

On first use or if not used for prolonged periods

Clean the IceMaker with TubeClean.

- ▶ Put an empty 1.5 l (1.59 qt) vessel (max. height 10 cm (3 15/16 in)) in the drawer under the IceMaker.
- ▶ Activate the TubeClean function.
- ▷ The rinse process is prepared (max. 60 min.): The symbol flashes.
- ▷ Water pipes are rinsed: Symbol flashes.
- ▷ Rinsing process is complete: Function turns off automatically.
- ▶ Take out the IceMaker drawer and remove the container.
- ▶ Clean the IceMaker drawer with warm water and a little detergent.
- ▶ Push in the IceMaker drawer.
- ▷ Ice cube production starts automatically.
- ▶ Dispose of any ice cubes that are produced within 24 hours of the first ice cube production.

When cleaning is required

Clean the IceMaker manually.

- ▶ Remove the IceMaker drawer and clean with warm water and a little detergent.
- ▶ Push in the IceMaker drawer.
- ▷ Ice cube production starts automatically.

9.3.6 After cleaning

- ▶ Wipe dry the appliance and items of equipment
- ▶ Connect and switch on the appliance.
- ▶ Activate SuperFrost (see 7.2 Appliance functions).
When the temperature is sufficiently cold
- ▶ Place the food inside.
- ▶ Repeat cleaning regularly.

Customer support

10 Customer support

10.1 Technical specifications

Temperature zone	
Freezing	-28 °C (-18 °F) to -15 °C (5 °F)

Maximum freezing quantity/24 h	
Freezer	See "Freezing capacity .../24 h" on the type plate

Max. equipment capacity			
Equipment	Appliance width 550 mm (21 5/8 in) (see installation instructions, appliance dimensions)	Appliance width 600 mm (23 1/2 in) (see installation instructions, appliance dimensions)	Appliance width 700 mm (27 9/16 in) (see installation instructions, appliance dimensions)
Drawer on glass shelf (see 8.1.1 Drawer on telescopic rails)	12 kg (26.46 lb)	15 kg (33.07 lb)	22 kg (48.50 lb)
Bottom drawer (see 8.1.3 Bottom drawer)	--	11 kg (24.25 lb)	19 kg (41.89 lb)
Top tilting drawer (see 8.1.2 Top tilting drawer)	--	19 kg (41.89 lb)	19 kg (41.89 lb)

Ice cube production with IceMaker+	
Ice cube production/24 h	At a temperature of -18 °C (-0 °F): 1.2 kg (2.65 lb) of ice cubes
Maximum ice cube production/24 h	When the MaxIce function is active: 1.6 kg (3.53 lb) of ice cubes

For appliances with a WiFi connection:

Frequency specification	
Frequency band	2.4 GHz
Maximum radiated power	< 100 mW
Purpose of the wireless equipment	Integration in the local WiFi network for data communication

10.2 Operating noises

The appliance makes noises while in operation.

- At **less cooling output** the appliance saves energy but takes longer to cool items. The volume is **lower**.
- At **a higher cooling output** the food cools more quickly. The volume is **higher**.

Examples:

- Activated functions (see 7.2 Appliance functions)
- Running fan
- Freshly sorted food
- High ambient temperature
- Door opened for long periods

Noise	Possible cause	Type of noise
Bubbling and splashing	Coolant is flowing into the cooling circuit.	Normal noise
Spitting and hissing	Coolant is spraying into the cooling circuit.	Normal noise
Humming	The appliance cools. The volume depends on the cooling output.	Normal noise
Sipping noises	The self-closing door is being opened and closed.	Normal noise
Whirring and murmuring	The fan is running.	Normal operating noise
Clicking	Components are being switched on and off.	Normal switching noise
Rattling humming	Valves are active.	Normal switching noise
Faint knocking, humming or buzzing*	The valve is active.	Normal operating noise

Noise	Possible cause	Type of noise	How to resolve
Vibration	Unsuitable setup	Error noise	Adjust the feet to make sure the appliance is horizontal.

Noise	Possible cause	Type of noise	How to resolve
Clattering	Equipment, Objects inside the appliance	Error noise	Secure equipment parts. Leave a gap between items.

nonetheless occurs during operation, please check whether the malfunction is due to an operating error. In this case, you will have to be charged for the costs incurred, even during the warranty period.

You may be able to rectify the following faults yourself.

10.3.1 Appliance function

10.3 Technical faults

Your appliance is designed and manufactured for reliable operation and a long service life. If a malfunction

Defect	Cause	Remedy
The appliance does not work.	The appliance is not switched on.	► Switch on the appliance.
	The power plug is not properly inserted in the wall socket.	► Check the power plug.
	The powerfuse in the wall socket is not OK.	► Check the fuse.
	Power failure.	► Keep the appliance closed. ► Protect food: Place cold storage batteries on the food or use another freezer appliance if the power failure lasts longer. ► Do not re-freeze defrosted food.
	The IEC socket is not correctly plugged into the appliance.	► Check the IEC socket.
The temperature is not cold enough	This means that the door of the appliance is not closed properly	► Close the appliance door
	Insufficient ventilation	► Clear and clean the ventilation grille.
	The ambient temperature is too high	► Problem solution: (see 1.4 Range of appliance use)
	The appliance was opened too frequently or for too long	► Wait to see if the required temperature corrects itself. If not, contact Customer Service. (see 10.4 Customer Service)
	Too much fresh food was placed inside without SuperFrost.	► Solution: (see SuperFrost)
	The temperature is incorrectly set	► Set to a colder temperature and check after 24 hours.
	The appliance is too near to a heat source (stove, heater etc).	► Change location of appliance or the heat source.
The door seal is defective or should be replaced for other reasons.	The door seal is interchangeable. You can replace it without the use of any special tools.	► Contact Customer Service. (see 10.4 Customer Service)
The appliance is iced up or	The door seal may have slipped out of its groove.	► Check the door seal is well placed in the groove.

Customer support

Defect	Cause	Remedy
condensation is building.		
The outside surfaces of the appliance are hot*.	The heat of the refrigerant circuit is used to prevent condensate from forming	▶ This is normal.

10.3.2 Equipment

Defect	Cause	Remedy
The IceMaker cannot be switched on.	The appliance and therefore the IceMaker are not connected.	▶ Connect the appliance (see Installation Guide).
The IceMaker is not making any ice cubes.	The IceMaker is not switched on.	▶ Activate the IceMaker.
	The drawer of the IceMaker is not properly closed	▶ Close the drawer properly
	The water connection is not open	▶ Open the water connection
The interior light does not turn on.	The appliance is not switched on.	▶ Switch on the appliance.
	The door was open for more than 15 minutes.	▶ If the door is open, the interior lighting switches off automatically after about 15 minutes.
	The LED interior light is faulty or the lid is damaged.	▶ Contact Customer Service. (see 10.4 Customer Service)

10.4 Customer Service

First check whether you can rectify the fault yourself (see 10 Customer support) . If you cannot rectify the problem, contact Customer Service.

You can find the address in the enclosed brochure "Liebherr-Service" or at home.liebherr.com/service.



WARNING

Unprofessional repair!
Injuries.

- ▶ A damaged power cable may only be replaced by the manufacturer, the manufacturer's Customer Service or a similarly qualified person.
- ▶ For appliances with plug and play connection cables, the change can be made by the customer.

10.4.1 Contacting Customer Service

Make sure that the following appliance information is available:

- Appliance name (model and index)
- Service no. (service)
- Serial no. (S no.)

- ▶ Call up the appliance information via the display. (see Appliance information)

-or-

- ▶ Refer to the type plate for appliance information. (see 10.5 Rating plate)

- ▶ Take note of the appliance information.
- ▶ Notify customer service: Report errors and the appliance information.
- ▷ This will help us give you fast and accurate support.
- ▶ Follow further instructions from Customer Service.

10.5 Rating plate

The nameplate is located behind the drawers on the inside of the appliance.

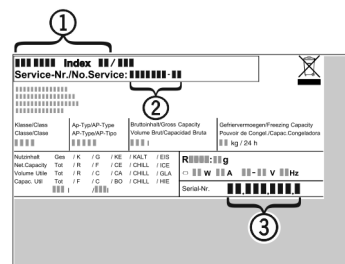

Fig. 117

- (1) Appliance name (3) Serial no.
 (2) Service no.
 ► Information from the nameplate.

11 Decommissioning

- Empty appliance.
- Deactivate IceMaker. (see Deactivating the IceMaker / MaxIce)
- Switch off appliance. (see Switching appliance off and on)
- Pull the power plug from the outlet.
- If necessary, remove the IEC socket: Pull the IEC socket out of the appliance plug while turning it to the left and right at the same time.
- Place a towel in front of the appliance to catch any water that may run out.
- Clean appliance. (see 9.3 Cleaning the appliance)
- Leave the door open to prevent unpleasant odors.

12 Disposal

12.1 Preparing the appliance for disposal



WARNING

Risk of child entrapment!

Before you throw away your old refrigerator or freezer:

- Take off the doors.
- Leave the shelves in place so that children may not easily climb inside.



Li-Ion

Liebherr uses batteries in some of its appliances. You should remove these before disposal of the old appliance for environmental reasons. If your appliance contains batteries, a corresponding notice is attached to the appliance.

Lamps If you can remove the lamps yourself without destroying them, also remove these before disposal.

- Take the appliance out of operation.
- If possible: Remove lamps without destroying them.

12.2 Disposing of the appliance in an environmentally friendly manner



The appliance still contains valuable materials and must be collected separately from unsorted municipal waste so it can be recycled.



Dispose of batteries separately from the old appliance. Certain batteries should NOT go in household garbage or recycling bins. Waste batteries can always be recycled or taken to household hazardous waste collection points. To prevent fires from lithium-ion batteries, tape battery terminals and/or place batteries in separate plastic bags and never put these batteries in household garbage or recycling bins.

Lamps

Dispose of removed lamps via the respective collection systems.

For USA:

Check the Responsible Appliance Disposal (RAD) program to find a RAD partner near you.

For Canada:

Follow your local guidance about recycling and disposal capabilities near you.



WARNING

Leaking refrigerant and oil!

Fire. The refrigerant contained within the appliance is environmentally friendly, but flammable. The oil contained within the appliance is flammable. Escaping refrigerant and oil can ignite if they are of high enough concentration and are exposed to an external heat source.

- Do not damage the pipelines of the coolant circuit and the compressor.

- Observe the notes on appliance transport.
- Transport the appliance away without damaging it.
- Dispose of batteries, lamps, and the appliance according to the above specifications.



home.liebherr.com/fridge-manuals

EN Freezer

Issue date: 20240905

Part number index: 7088351-00

For Service in the U.S.: Liebherr Service Center
Toll Free: 1-866-LIEBHER or 1-866-543-2437
Service-appliances.us@liebherr.com
PlusOne Solutions, Inc.
3501 Quadrangle Blvd, Suite 120
Orlando, FL 32817

For Service in Canada: Liebherr Service Center
Toll Free: 1-888-LIEBHER or 1-888-543-2437
www.euro-parts.ca
EURO-PARTS CANADA
39822 Belgrave Road, Belgrave, Ontario, N0G 1E0
Phone: (519) 357-3320 | Fax: (519) 357-1326