SBSes 8486

Side-by-Side combination
PremiumPlus

LIEBHERR

Freestanding



SWTNes 4265

Fridge-freezer with NoFrost
PremiumPlus



← 60 →



Energy consump. in 365 days/24 h	kWh¹
Total net	Fridge: 153 l including wine compartment: 153 l / Freezer compartment: 126 l
Frequency / voltage	60 Hz / 115 V-
Connection Rating	2.0 A 231 W
Door / Side walls	SmartSteel / SmartSteel
Exterior dimensions in cm (h / w / d)	185 / 60 / 68.5¹
Controls	
Type of Control	2.4" TFT-colour display behind-the-door, touch electronic Digital temperature display for wine and freezer compartments
Door alarm	visual and acoustic
Alarm in case of malfunction	visual and acoustic
Fridge compartment	
Forced air system	PowerCooling with FreshAir activated charcoal filter
Freezer compartment	
Star coding	****
Interior light	LED lighting
Number of drawers	5 drawers, of which 2 set on roller tracks, VarioSpace
IceMaker	with fixed 3/4" water connection
Ice cube capacity in 24 hours	- kg
Ice cube stock	1.8 kg
Cold storage accumulators	2
Features	
Side-by-Side concept	Side wall heating right, suitable for combination with other refrigerators, freezers and/or wine appliances
Door hinges	Reversible door hinge, left
EAN-Nr.	4016803050698

¹ To achieve the indicated energy consumption level, the wall spacers provided with the appliance must be used. These increase the appliance depth by approximately 1.5 cm. If the wall spacers are not used, the appliance will remain fully functional, but will have a slightly higher energy consumption level.

Features

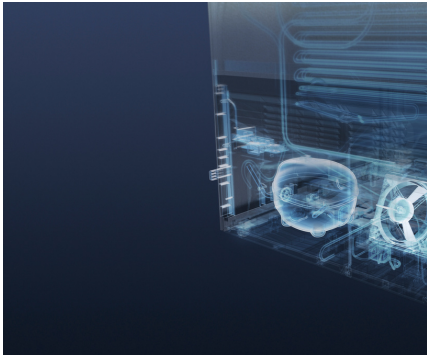

BluPerformance

Offering even more interior capacity for food storage, economy and energy efficiency, quiet operation, ease-of-use and exceptional design: Liebherr's BluPerformance appliances set both a new direction in refrigeration and freezing, and new benchmarks.



NoFrost

The NoFrost system from Liebherr provides rapid, fan-assisted, frost-free freezing for the safe, longterm storage of food. The NoFrost technology creates a much larger storage capacity and keeps the freezer constantly frost-free.

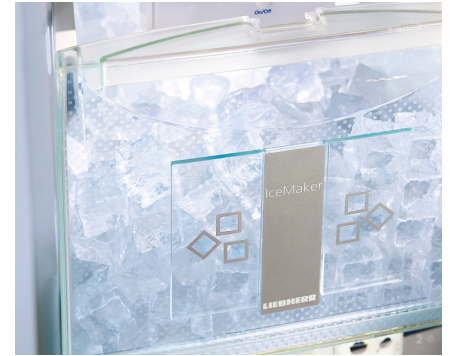

IceMaker with fixed water connection

The plumbed-in IceMaker automatically keeps you topped up with the finest quality ice cubes so that you are prepared for every occasion.



VarioSpace

Freezer drawers and toughened glass shelves can be removed. VarioSpace – the practical storage solution for larger items.

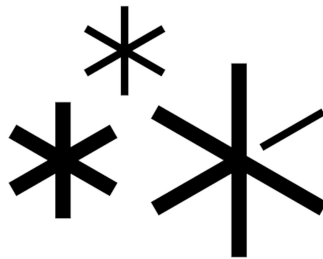

SuperFrost

SuperFrost generates greater cold reserves so that freshly stored food can be frozen rapidly, in a vitamin-preserving manner. Reversion from the freezing temperature of -32 °C to the normal freezer temperature is time or quantity-controlled to help save energy.

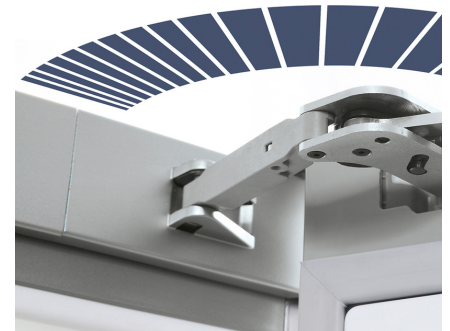

Softsystem

The integrated SoftSystem mechanism cushions door closure even when the door shelves are fully stocked; it ensures gentle closing and prevents bottles, jars and packets or food from falling out of the door.

SKBes 4360

Refrigerator with BioFresh
PremiumPlus



← 60 →



Energy consump. in 365 days/24 h	kWh¹
Total net	Fridge: 366 l including BioFresh compartment: 132 l
Frequency / voltage	60 Hz / 115 V~
Connection Rating	2.0 A
Door / Side walls	SmartSteel / SmartSteel
Exterior dimensions in cm (h / w / d)	185 / 60 / 66.5¹
Controls	
Type of Control	2.4" TFT-colour display behind-the-door, touch electronic Digital temperature display for fridge and BioFresh compartments
Door alarm	visual and acoustic
Alarm in case of malfunction	visual and acoustic
Fridge compartment	
Forced air system	PowerCooling with FreshAir activated charcoal filter
Door interior	Premium GlassLine storage shelf with bottle holder, VarioBoxes, adjustable egg tray, butter dish
VarioSafe	yes
Bottle shelf	Variable bottle shelf
Interior light	LED ceiling lighting with dimmer function LED BioFresh lighting LED rear wall lighting
BioFresh-Safes	3 BioFresh-Safes with SoftTelescopic, of which 2 variably adjustable from Fruit & Vegetable-Safe to DrySafe, 1 Fish & Seafood-Safe
Features	
Side-by-Side concept	Side wall heating left, suitable for combination with other refrigerators, freezers and/or wine appliances
Door hinges	Reversible door hinging
EAN-Nr.	4016803051169

¹ To achieve the indicated energy consumption level, the wall spacers provided with the appliance must be used. These increase the appliance depth by approximately 1.5 cm. If the wall spacers are not used, the appliance will remain fully functional, but will have a slightly higher energy consumption level.

Features

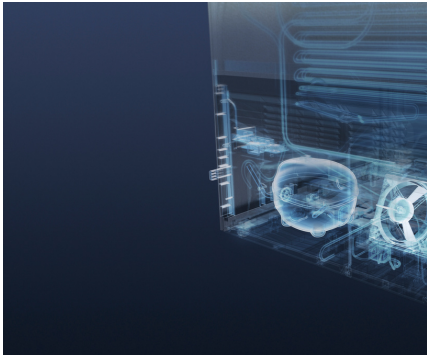

BluPerformance

Offering even more interior capacity for food storage, economy and energy efficiency, quiet operation, ease-of-use and exceptional design: Liebherr's BluPerformance appliances set both a new direction in refrigeration and freezing, and new benchmarks.



BioFresh-Plus

BioFresh-Plus with separate electronics provides even more flexibility for individual grocery storage: For example, the temperature in the top compartment can be lowered to -2 °C to store fish. In combination with the DrySafe setting, this keeps fish and seafood fresh for even longer.



Versatile bottle shelf

The versatile bottle shelf is an innovative feature in all BioFresh Premium models. It can be positioned above or below the glass shelf to suite individual requirements.

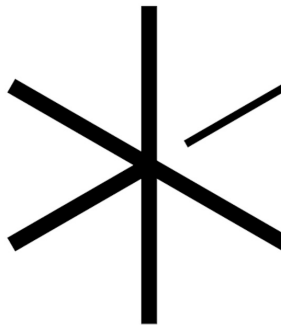

SuperCool

SuperCool generates greater cold reserves so that freshly stored food can be rapidly chilled. Reversion from the chilling temperature of +2 °C to the normal refrigeration temperature is time or quantity-controlled to help save energy.

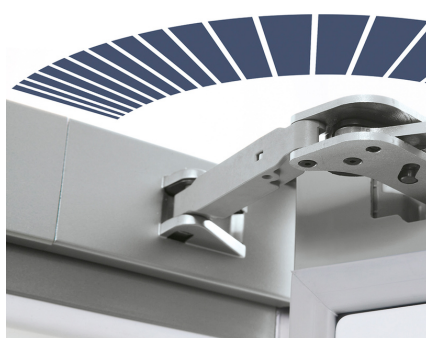

Softsystem

The integrated SoftSystem mechanism cushions door closure even when the door shelves are fully stocked; it ensures gentle closing and prevents bottles, jars and packets or food from falling out of the door.



SmartSteel

SmartSteel significantly reduces the visibility of fingerprints. The high-quality stainless steel finish makes SmartSteel surfaces particularly easy-to-clean and far more scratch-resistant.

Technical drawing

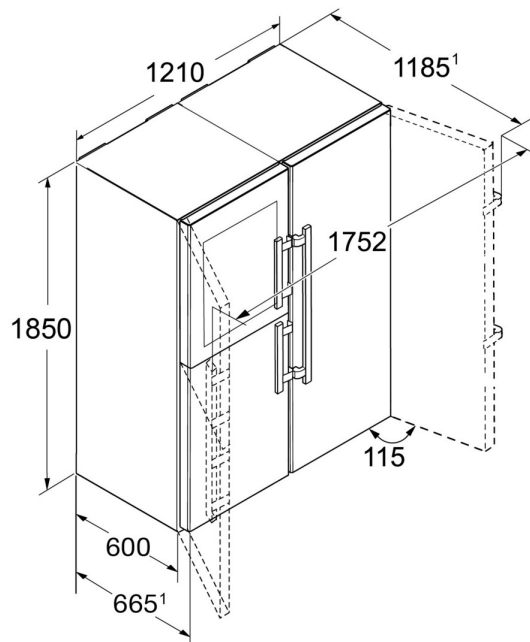

Products and their details are staged for advertising purposes. Whilst every effort is made to ensure all specifications and information in this flyer are accurate, Liebherr reserves the right to make changes without notification. Where actual appliance measurements, specifications, and ratings are crucial, we recommend that the actual appliance installation instructions that accompany each appliance be checked. Liebherr will not be liable for any damage. (03.03.2023)

