

Operating instructions

integrated full-height BioFresh fridge

EN

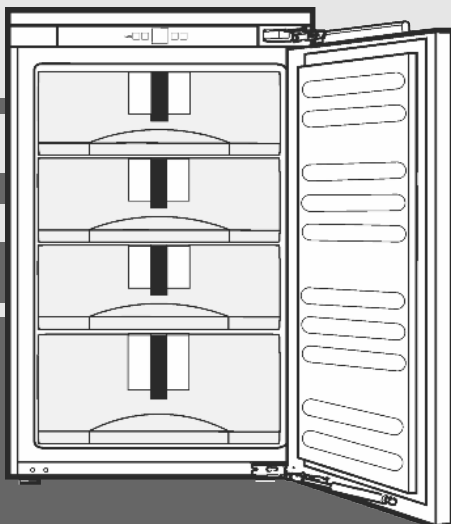

20190724 **7086584 - 00**

(S)IB(P)1650

LIEBHERR

Contents

1	Appliance at a glance	2
1.1	Description of appliance and equipment.....	2
1.2	Appliance range of use.....	2
1.3	Conformity.....	3
1.4	Product data.....	3
1.5	Saving energy.....	3
2	General safety information	3
3	Controls and displays	4
3.1	Operating and control elements.....	4
3.2	Temperature display.....	4
4	Putting into operation	4
4.1	Switching on the appliance.....	4
5	Control	4
5.1	Child proofing.....	4
5.2	Door alarm.....	5
5.3	Storing food.....	5
5.4	Storage times.....	5
5.5	Setting the temperature.....	5
5.6	Adjusting the humidity.....	6
5.7	Drawers.....	6
5.8	Information system.....	6
5.9	Using the FlexSystem.....	6
5.10	Shelves.....	6
5.11	VarioSpace.....	7
6	Maintenance	7
6.1	Defrosting with NoFrost.....	7
6.2	Cleaning the appliance.....	7
6.3	Customer service.....	7
7	Malfunctions	7
8	Decommissioning	8
8.1	Switching off the appliance.....	8
8.2	Taking the appliance out of service.....	8
9	Disposing of the appliance	8

The manufacturer works constantly on the further development of all the types and models. Therefore please understand that we have to reserve the right to make design, equipment and technical modifications.

To get to know all the benefits of your new appliance, please read the information contained in these instructions carefully.

The instructions apply to several models. Differences may occur. Text relating only to specific appliances is marked with an asterisk (*).

Instructions for action are marked with a ►, the **results of action** are marked with a ▷.

1 Appliance at a glance

1.1 Description of appliance and equipment

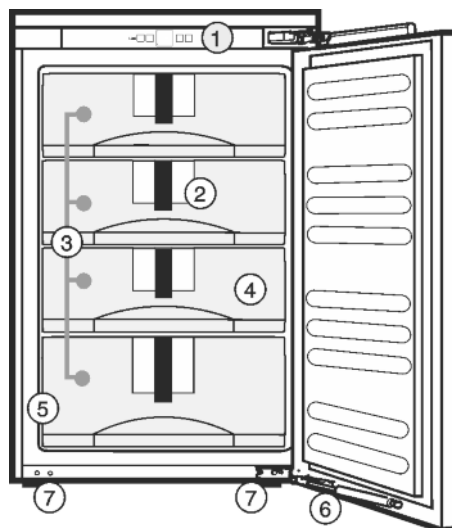

Fig. 1

- | | |
|------------------------------------|----------------------------|
| (1) Operating and control elements | (5) Type plate |
| (2) Information system | (6) Soft stop mechanism |
| (3) Drawers | (7) Height-adjustable feet |
| (4) VarioSpace | |

Note

- Shelves, drawers and baskets are arranged for optimum energy efficiency on delivery.

1.2 Appliance range of use

Intended use

The appliance is only suitable for cooling food products in a domestic or household-like environment. This includes, for example, use:

- in staff kitchens, bed and breakfast establishments,
- by guests in country houses, hotels, motels and other accommodation,
- for catering and similar services in the wholesale trade.

All other types of use are not permitted.

Foreseeable misuse

The following applications are expressly forbidden:

- Storing and refrigerating medicines, blood plasma, laboratory preparations or similar substances and products based on the Medical Device Directive 2007/47/EC
- Use in areas at risk of explosions

Misusing the appliance may lead to damage to the goods stored or they may spoil.

Climate classifications

Depending on the climate classification the appliance is designed to operate in restricted

ambient temperatures. The climate classification applying to your appliance is printed on the rating plate.

Note

► Keep to the specified ambient temperatures in order to guarantee that the appliance works properly.

Climate classification	for ambient temperatures of
SN	10 °C to 32 °C
N	16 °C to 32 °C
ST	16 °C to 38 °C
T	16 °C to 43 °C

1.3 Conformity

The refrigerant circuit has been tested for leaks. In installed condition, this appliance complies with the applicable safety stipulations and with directives 2014/35/EU, 2014/30/EU, 2009/125/EG, 2011/65/EU and 2010/30/EU.

The BioFresh compartment satisfies the requirements for a cold storage compartment in acc. with DIN EN 62552.

1.4 Product data

Product data is included with the appliance, as per Directive (EU) 2017/1369. The complete product data sheet is available on the Liebherr website under Downloads.

1.5 Saving energy

- Pay attention to good ventilation. Do not cover ventilation holes or grids.
- Always keep the fan air slits clear.
- Do not install the appliance in direct sunlight, next to an oven, radiator or similar.
- Energy consumption is dependent on the installation conditions, e.g. ambient temperature (see 1.2) . If the ambient temperature deviates from the standard temperature of 25°C, the energy consumption may differ.
- Open the appliance for as short a time as possible.
- The lower the temperature is set the higher the energy consumption.
- Keep all food properly packed and covered. This prevents frost from forming.
- Only take food out for as long as necessary so that it doesn't warm up too much.
- Inserting warm food: allow to cool down to room temperature first.

2 General safety information

Danger for the user:

- This device can be used by children and people with impaired physical, sensory or mental abilities or with a lack of experience and knowledge provided that they are supervised or have received instruction in the safe use of this device, and about the resulting hazards. Children must not play with this appliance. Cleaning and user maintenance

work must not be carried out by children without adult supervision. Children aged between 3 and 8 are allowed to load and unload the appliance. Children below the age of 3 must be kept away from the appliance unless they are under continuous adult supervision.

- When disconnecting the appliance from the supply, always take hold of the plug. Do not pull the cable.
- In the event of a fault pull out the mains plug or deactivate the fuse.
- Do not damage the mains power cable. Do not operate the appliance with a defective mains power cable.
- Repairs, interventions on the appliance and the replacement of mains connection line may only be carried out by After-Sales Service or other suitably trained specialist personnel.
- Only install, connect and dispose of the appliance according to the instructions.
- Only use the appliance when it is installed.
- Please keep these instructions in a safe place and pass them on to any subsequent owners.

Fire hazard:

- The coolant used (information on the model plate) is eco-friendly but also flammable. Any leaking coolant may ignite.
 - Do not damage the refrigerant circuit pipes.
 - Do not use an open flame or other source of ignition inside the appliance.
 - Do not use electrical appliances inside the appliance (e.g. steam cleaners, heaters, ice cream makers, etc.).
 - If the refrigerant leaks: remove any naked flames or ignition sources from the vicinity of the leakage point. Properly air the room. Inform customer services.
- Do not store explosives or sprays using combustible propellants such as butane, propane, pentane, etc. in the appliance. To identify these spray cans, look for the list of contents printed on the can, or a flame symbol. Gases possibly escaping may ignite due to electrical components.
- Please be sure to store alcoholic drinks or other packaging containing alcohol in tightly closed containers. Any alcohol that leaks out may be ignited by electrical components.

Danger of tipping and falling:

- Do not misuse the plinth, drawers, doors etc. as a step or for support. This applies particularly to children.

Danger of food poisoning:

Controls and displays

- Do not consume food which has been stored too long.

Danger of frostbite, numbness and pain:

- Avoid lasting skin contact with cold surfaces or refrigerated/frozen food or take protective steps, e.g. wear gloves. Do not consume ice cream, water ice or ice cubes immediately and do not consume them too cold.

Danger of injury and damage:

- Hot steam can lead to injury. Do not use electrical heating or steam cleaning equipment, open flames or defrosting sprays to defrost.
- Do not use sharp implements to remove the ice.

Danger of crushing:

- Do not hold the hinge when opening and closing the door. Fingers may get caught.

Symbols on the appliance:

	The symbol can be located on the compressor. It refers to the oil in the compressor and indicates the following danger: Swallowing or inhaling can be fatal. This is only relevant for recycling. There is no danger in normal operation.
	This symbol is found on the compressor and indicates the danger of flammable materials.
	A sticker to this effect may be applied to the rear of the appliance. It refers to the foam-padded panels in the door and/or the housing. This is only relevant for recycling. Do not remove the sticker.

Please observe the specific information in the other sections:

	DANGER	identifies a situation involving direct danger which, if not obviated, may result in death or severe bodily injury.
	WARNING	identifies a dangerous situation which, if not obviated, may result in death or severe bodily injury.
	CAUTION	identifies a dangerous situation which, if not obviated, may result in minor or medium bodily injury.
	NOTICE	identifies a dangerous situation which, if not obviated, may result in damage to property.
	Note	identifies useful information and tips.

3 Controls and displays

3.1 Operating and control elements

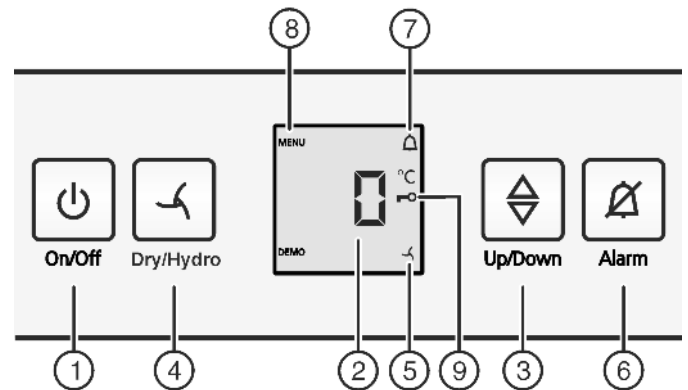

Fig. 2

- (1) On/Off button
- (2) Temperature display
- (3) Up/Down button
- (4) Dry/Hydro button
- (5) Dry/Hydro symbol
- (6) Alarm button
- (7) Alarm symbol
- (8) Menu symbol
- (9) Child lock symbol

3.2 Temperature display

During normal operation, the display shows:

- the BioFresh temperature setting

The temperature display flashes if/when:

- You change the temperature setting

The following displays indicate a fault. Possible causes and solutions: (see 7) .

- F0 to F9

4 Putting into operation

4.1 Switching on the appliance

- ▶ Open the door.
- ▶ Press On/Off button Fig. 2 (1).
- ▷ The temperature display shows the set temperature.
- ▷ If "DEMO" is displayed, demo mode is activated. Please contact the after sales service.

5 Control

5.1 Child proofing

The child-proofing function enables you to make sure that the appliance is not inadvertently switched off by playing children.

5.1.1 Setting the child lock

- ▶ To activate setting mode: press the Dry/Hydro button Fig. 2 (4) for approx. 6 seconds.
- ▷ The display indicates **c**.
- ▷ The menu symbol Fig. 2 (8) shines.
- ▶ Briefly press the Dry/Hydro button Fig. 2 (4) to confirm. When **c** is indicated in the display:
- ▶ Briefly press the Dry/Hydro button Fig. 2 (4) to activate the child lock.
- ▷ The child lock symbol Fig. 2 (9) shines. **c** flashes in the display.

When **c0** is indicated in the display:

- ▶ Briefly press the Dry/Hydro button *Fig. 2 (4)* to deactivate the child lock.
 - ▷ The child lock symbol *Fig. 2 (9)* goes out. **c** flashes in the display.
 - ▶ To deactivate the setting mode: Press the On/Off button *Fig. 2 (1)*.
- or-**
- ▶ Wait for 5 minutes.
 - ▷ The temperature is indicated again in the temperature display.

5.2 Door alarm

An audible warning sounds if the door is open for longer than 60 seconds.

The audible warning stops automatically when the door is closed.



5.2.1 Muting the door alarm

The audible alarm can be muted when the door is open. The sound switch-off function is active as long as the door is left open.

- ▶ Press alarm button *Fig. 2 (6)*.
- ▷ The door alarm is silenced.

5.3 Storing food

Note

- ▶ Do not put the following in the BioFresh section: cold-sensitive vegetables including cucumbers, aubergines, tomatoes, courgettes and any cold-sensitive tropical fruits.

- ▶ To prevent food spoilage due to transfer of germs: Store unwrapped animal and vegetable products separate from one another in the drawers. This also applies to different sorts of meat.

If food has to be stored together due to lack of space:

- ▶ wrap the food.
- ▶ Each drawer can hold max. 25 kg.
- ▶ The shelves can each be loaded with 35 kg.

5.4 Storage times

Guidelines for storage periods at low humidity 0 °C			
Butter	up to	90	days
Hard cheese	up to	110	days
Milk	up to	12	days
Cold meats	up to	9	days
Poultry	up to	6	days
Pork	up to	7	days
Beef	up to	7	days
Game	up to	7	days

Note

- ▶ Please note that protein-rich food deteriorates faster, i.e. shellfish and crustaceans deteriorate faster than fish, fish faster than meat.

Guidelines for storage periods at high humidity 0 °C			
Vegetables, salads			
Artichokes	up to	14	days

Guidelines for storage periods at high humidity 0 °C			
Celery	up to	28	days
Cauliflower	up to	21	days
Broccoli	up to	13	days
Chicory	up to	27	days
Leaf lettuce	up to	19	days
Peas	up to	14	days
Kale	up to	14	days
Carrots	up to	80	days
Garlic	up to	160	days
Cabbage	up to	55	days
Round lettuce	up to	13	days
Herbs	up to	13	days
Leeks	up to	29	days
Mushrooms	up to	7	days
Radishes	up to	10	days
Sprouts	up to	20	days
Asparagus	up to	18	days
Spinach	up to	13	days
Savoy cabbage	up to	20	days
Fruit			
Apricots	up to	13	days
Apples	up to	80	days
Pears	up to	55	days
Blackberries	up to	3	days
Dates	up to	180	days
Strawberries	up to	7	days
Figs	up to	7	days
Blueberries	up to	9	days
Raspberries	up to	3	days
Red currants	up to	7	days
Cherries, sweet	up to	14	days
Kiwis	up to	80	days
Peaches	up to	13	days
Plums	up to	20	days
Cranberries	up to	60	days
Rhubarb	up to	13	days
Gooseberries	up to	13	days
Grapes	up to	29	days

EN

5.5 Setting the temperature

The temperature is automatically regulated to just above 0 °C.

You can set a slightly higher or lower temperature. The temperature can be adjusted between **b1** (coldest temperature) and **b9** (hottest temperature) The default is **b5**. With levels **b1** to **b4** the temperature may drop below 0 °C so that the food can freeze.

Control

- ▶ Setting a higher temperature: Press the Up/Down *Fig. 2 (3)* button until the temperature flashes on the display. Release the button.
- ▶ Setting a lower temperature: Press the Up/Down *Fig. 2 (3)* button until the temperature flashes on the display. Release the button.
- ▷ The previous value is indicated in the temperature display.
- ▶ To change the temperature in steps: Briefly press the button.
- or-
- ▶ To change the temperature continuously: Hold down the button.
- ▷ During the adjustment, **b1** to **b9** are displayed.
- ▷ The actual temperature is displayed about 5 seconds after the last press of a button. The temperature slowly adjusts to the new value.



5.6 Adjusting the humidity

The humidity in the appliance can be adjusted depending on what type of food is placed inside.

The **dry** setting produces a dry atmosphere suitable for storing dry or wrapped food (dairy products, meat, fish, sausages). The appliance has the lowest energy consumption in this operating mode.

The **hydro** setting produces a humid atmosphere suitable for storing unwrapped salad, vegetables and fruit with high intrinsic moisture. When the drawers are well filled, a dewy atmosphere with a humidity of up to 90% max. is established.

The humidity in the compartment depends on the moisture content of the food stored and on the opening frequency. **dry** is preset.

- ▶ Setting **hydro**: Press the dry/hydro *Fig. 3 (4)* button until the  symbol appears. Release the button.
- ▷ The dry/hydro *Fig. 3 (5)* symbol lights up.
- ▶ Setting **dry**: Press the dry/hydro *Fig. 3 (4)* button until the  symbol goes out. Release the button.

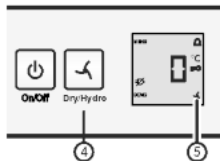
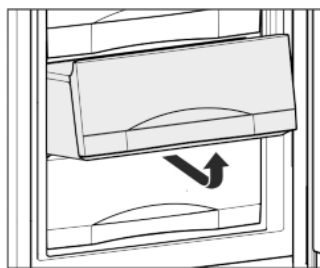

Fig. 3

5.7 Drawers



- ▶ To store the food straight on the shelves: Pull the drawer forwards and lift it out.

5.8 Information system

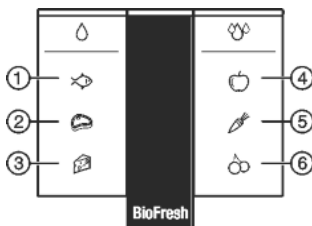
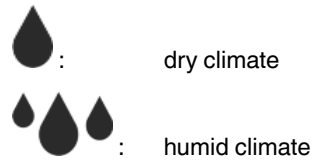

Fig. 4

- | | |
|------------|----------------|
| (1) Fish | (4) Fruit |
| (2) Meat | (5) Vegetables |
| (3) Cheese | (6) Fruit |

The drops indicate the storage climate of the food shown.



5.9 Using the FlexSystem

The FlexSystem helps you store and organise your food in a clear and flexible way. It lets you clearly divide your food into fruit, vegetables or by use-by dates, for example.

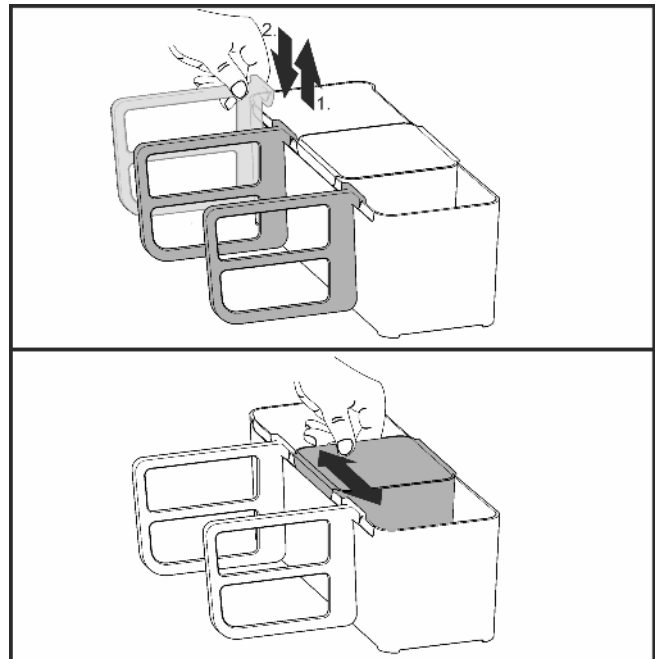

Fig. 5

- ▶ You can take the FlexSystem apart for cleaning.

5.10 Shelves

5.10.1 Moving shelves

- ▶ To remove the shelf: lift up at the front and pull out.
- ▶ To put the shelf back: simply push in as far as it will go.

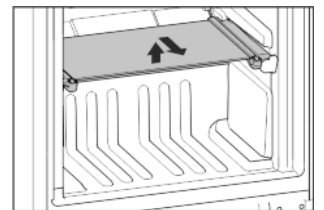

5.10.2 Removing shelves

- ▶ The shelves may be removed for cleaning.

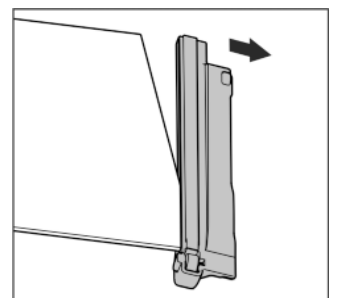

5.11 VarioSpace

You can remove the shelves and drawers. This leaves more room for larger food items such as poultry, meat, large game and tall baked goods, which can be frozen whole before further preparation.

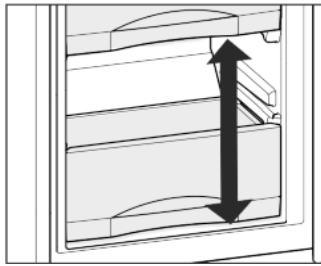

- ▶ Each drawer can hold max. 25 kg of frozen food.
- ▶ The shelves can each be loaded with 35 kg of frozen food.

6 Maintenance

6.1 Defrosting with NoFrost

The NoFrost system automatically defrosts the appliance. The moisture condenses on the evaporator, is periodically defrosted and evaporates.

- ▶ The appliance does not have to be manually defrosted.

6.2 Cleaning the appliance

Clean the appliance regularly.



WARNING

Risk of injury and damage as a result of hot steam! Hot steam can lead to burns and can damage the surfaces.

- ▶ Do not use any steam cleaners!

NOTICE

Incorrect cleaning damages the appliance!

- ▶ Do not use cleaning agents in concentrated form.
- ▶ Do not use any scouring or abrasive sponges or steel wool.
- ▶ Do not use any sharp or abrasive cleaning agents, nor any that contain sand, chloride or acid.
- ▶ Do not use chemical solvents.
- ▶ Do not damage or remove the type plate on the inside of the appliance. It is important for the customer service.
- ▶ Do not pull off, bend or damage cables or other components.
- ▶ Do not allow any cleaning water to enter the drain channel, ventilation grille or electrical parts.
- ▶ Please use soft cleaning cloths and a universal pH-neutral cleaning agent.
- ▶ Please use cleaning and care products suitable for contact with foodstuffs in the appliance interior.

- ▶ **Empty appliance.**
- ▶ **Pull out the power plug.**



- ▶ Clean the **vent grille** regularly.
 - ▷ Dust deposits increase energy consumption.
- ▶ Clean **plastic outer and inner surfaces** with lukewarm water and a little washing-up liquid.
- ▶ Most of the **parts** can be dismantled for cleaning: see the relevant chapter.
- ▶ **Clean drawers** by hand with lukewarm water and a little washing up liquid.
- ▶ All the **other fittings** can be put in the dishwasher.

After cleaning:

- ▶ Wipe dry the appliance and items of equipment.
- ▶ Connect the appliance and switch it on again. When the temperature is sufficiently cold:
- ▶ Put the food back inside.

6.3 Customer service

First check whether you can correct the fault yourself by reference to the list (see 7). If this is not the case, please contact the customer service whose address is given in the enclosed customer service list.



WARNING

Risk of injury if repair work is not carried out professionally!

- ▶ Have any repairs and action - not expressly specified - on the appliance and mains cable carried out by service personnel only. (see 6)

- ▶ Read the appliance designation *Fig. 6 (1)*, service No. *Fig. 6 (2)* and serial No. *Fig. 6 (3)* off the type plate located inside the appliance on the left-hand side.

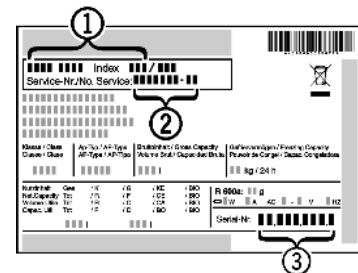

Fig. 6

- ▶ Notify the customer service, specifying the fault, appliance designation *Fig. 6 (1)*, service No. *Fig. 6 (2)* and serial No. *Fig. 6 (3)*.
 - ▷ This will help us to provide you with a faster and more accurate service.
- ▶ Keep the appliance closed until the customer service arrives.
 - ▷ The food will stay cool longer.
- ▶ Pull out the mains plug (not by pulling the connecting cable) or switch off the fuse.

EN

7 Malfunctions

Your appliance is designed and manufactured for a long life span and reliable operation. If a malfunction nonetheless occurs during operation, check whether it is due to a handling error. In this case you will have to be charged for the costs incurred, even during the warranty period. You may be able to rectify the following faults yourself:

Appliance does not work.

- The appliance is not switched on.
- ▶ Switch on the appliance.
- The power plug is not properly inserted in the wall socket.
- ▶ Check power plug.
- The fuse of the wall socket is not in order.
- ▶ Check fuse.

The compressor runs for a long time.

- The compressor switches to a low speed when little cold is needed. Although the running time is increased as a result, energy is saved.
- ▶ This is normal in energy-saving models.

A LED on the bottom rear of the appliance (at the compressor) flashes repeatedly every 5 seconds*.

- There is a fault.
- ▶ Please contact the after-sales service (see 6).

Excessive noise.

- Due to the various speed steps, speed-regulated* compressors can generate different running noises.
- ▶ The sound is normal.

A bubbling and gurgling noise.

- This noise comes from the refrigerant flowing in the refrigeration circuit.
- ▶ The sound is normal.

Decommissioning

A quiet clicking noise.

→ The noise is produced whenever the refrigeration unit (motor) automatically switches on or off.

- ▶ The sound is normal.

A hum. It is briefly a little louder when the refrigeration unit (the motor) switches on.

→ The refrigeration increases automatically when fresh food has just been placed in the appliance or the door has been left open for a while.

- ▶ The sound is normal.

→ The ambient temperature is too high.

- ▶ Solution: (see 1.2)

A low hum.

→ The sound is produced by air flow noise of the fan.

- ▶ The sound is normal.

The fan runs for a long time

→ With the “hydro” setting, the fan has to run longer for functional reasons.

- ▶ This is normal.

Vibration noises

→ The appliance is not standing firmly on the floor. As a result objects and adjacent units start to vibrate when the refrigerator is running.

- ▶ Check the installation and realign the appliance.

Flow sound at the soft stop mechanism.

→ The noise is produced when the door is opened and closed.

- ▶ The sound is normal.

The temperature display indicates: F0 to F9

→ There is a fault.

- ▶ Please contact the after-sales service (see 6) .

DEMO shines in the temperature display.

→ The demo mode is activated.

- ▶ Please contact the after-sales service (see 6) .

The outer surfaces of the appliance are warm*.

→ The heat of the refrigeration circuit is used to prevent condensate from forming.

- ▶ This is normal.

The temperature is not cold enough.

→ The door of the appliance is not properly closed.

- ▶ Close the door of the appliance.

→ Insufficient ventilation.

- ▶ Keep ventilation grille clear, and clean it.

→ The ambient temperature is too high.

- ▶ Solution: (see 1.2) .

→ The appliance was opened too frequently or for too long.

- ▶ Wait to see whether the appliance reaches the required temperature by itself. If not, please contact the after sales service (see 6) .

→ The temperature is incorrectly set.

- ▶ Set the temperature to a colder setting and check after 24 hours.

→ The appliance is too close to a source of heat (stove, heater etc).

- ▶ Change the position of the appliance or the source of heat.

→ The appliance was not inserted properly into the recess.

- ▶ Check whether the appliance was inserted correctly and the door closes properly.

8 Decommissioning

8.1 Switching off the appliance

- ▶ Press On/Off button *Fig. 2 (1)* for approx. 2 seconds.

▷ A long beep is emitted. The temperature display is dark. The appliance is switched off.

- ▷ If the appliance cannot be switched off, the child lock function is active (see 5.1) .



8.2 Taking the appliance out of service

- ▶ Empty the appliance.
- ▶ Switch off the appliance (see 8) .
- ▶ Remove mains connector.
- ▶ Clean the appliance (see 6.2) .



- ▶ Leave the door open to prevent odour.

9 Disposing of the appliance

The appliance contains some reusable materials and should be disposed of properly - not simply with unsorted household refuse. Appliances which are no longer needed must be disposed of in a professional and appropriate way, in accordance with the current local regulations and laws.



When disposing of the appliance, ensure that the refrigeration circuit is not damaged to prevent uncontrolled escape of the refrigerant it contains (data on type plate) and oil.

- ▶ Disable the appliance.
- ▶ Pull out the plug.
- ▶ Cut through the connecting cable.



Liebherr-Hausgeräte Ochsenhausen GmbH

Memminger Straße 77-79

88416 Ochsenhausen

Deutschland

home.liebherr.com