

Operating instructions

Multi-temperature wine cabinet

Read the operating instructions before switching on for the first time

Page 28

EN



7085 981-01



EWT 91 / EWT 92 / EWP. 94.. / EWP. 96..

LIEBHERR

Content

Priority of warnings.....	28
Safety instructions and warnings	28
Symbols on the appliance:.....	29
Description of the appliance.....	30
Climate rating	31
Range of appliance use.....	31
Disposal notes.....	31
EPREL database:.....	31
Control panel.....	32
Fast access to information	32
Switching the appliance on	32
Changing language and temperature unit.....	32
Main menu.....	33
Setting the temperature.....	33
Fan	34
Presentation light.....	34
SabbathMode.....	35
Switching the appliance off	35
Maintenance message	36
Maintenance confirmation.....	36
Setup menu	37
SmartDeviceBox (not supplied in all countries).....	39
Description of the SmartDevice display	39
Alarm messages	40
Storage diagram.....	42
Equipment	43
Cleaning	45
Removing and inserting the wooden shelves.....	45
Maintenance menu.....	47
Maintenance.....	48
Additional functions.....	49
Malfunctions.....	52
Shutting your appliance down	52

Priority of warnings



 DANGER!	identifies a situation involving direct danger which, if not obviated, may result in death or severe bodily injury.
 WARNING!	identifies a dangerous situation which, if not obviated, may result in death or severe bodily injury.
 CAUTION!	identifies a dangerous situation which, if not obviated, may result in minor or medium bodily injury.
NOTICE	identifies a dangerous situation which, if not obviated, may result in damage to property.
Note	identifies useful information and tips.

Safety instructions and warnings

- **WARNING:** do not seal ventilation openings on the appliance housing or enclosure.
- **WARNING:** only use the mechanical devices or other aids recommended by the manufacturer to help speed up the defrosting process.
- **WARNING:** do not damage the refrigerant circuit.
- **WARNING:** do not use any electrical devices in the refrigerator compartment which do not comply with the design recommended by the manufacturer.
- **WARNING:** the mains cable must not be damaged while installing the appliance.
- **WARNING:** multi-sockets or distributor strips and other electronic devices (such as halogen transformers) must not be positioned and operated at the rear of appliances.
- **WARNING:** danger of injury through electric shock. There are live parts under the cover. Only have the interior LED light replaced or repaired by customer service staff or trained personnel.
- **WARNING:** risk of injury from the LED lamp. The light intensity of the LED light complies with laser class RG 2. If the cover is defective, do not look directly at the light through optical lenses from close distance. This may damage your eyes.
- **WARNING:** this appliance must be secured as described in the operating instructions (installation instructions) to rule out any potential risks due to its instability.
- Do not stand on the plinth, drawers or doors or use them to support anything else.
- This appliance may be used by children aged 8 and over and by people with reduced physical, sensory or mental abilities or a lack of experience and expertise if they are supervised or have been instructed on the safe use of the appliance and have understood the risks associated with it. Children must not be allowed to play with the appliance. Cleaning and user maintenance must not be carried out by children without supervision. Children aged between 3 and 8 are allowed to load and unload the appliance.
- Do not store any explosive substances, such as aerosol containers with flammable propellant gas, inside the appliance.

Symbols on the appliance:

- To prevent injury and damage to property, the appliance should only be installed by two people.
- After unpacking it, check the appliance for signs of damage. Contact the supplier if it is damaged. Do not connect the appliance to the mains power supply.
- Avoid prolonged skin contact with cold surfaces (e.g. chilled/frozen products). If necessary, take safety action (e.g. gloves).
- Do not consume food which has been stored for too long, as it could cause food poisoning.
- All repairs and work on the appliance may only be carried out by customer service personnel or other trained personnel. The same applies to changing the mains power cable.
- Only carry out repair and other work on the appliance when the mains plug has visibly been disconnected.
- Only install, connect and dispose of the appliance as described in these operating instructions.
- In the event of a fault, pull out the plug or switch off the fuse.
- When disconnecting the appliance from the mains, pull on the plug. Do not pull on the cable.
- If you have a lockable appliance, do not keep the key near the appliance or within reach of children.
- The appliance is designed for use in enclosed areas. Do not operate the appliance outdoors or in areas where it is exposed to splash water or damp conditions.
- Do not use the interior LED light to light the room. The interior LED light is only designed to illuminate the interior of the appliance.
- Do not allow naked flames or ignition sources to enter the appliance.
- Alcoholic drinks or other vessels containing alcohol should be sealed tightly for storage.

	<p>This symbol may be located on the compressor. It relates to the oil in the compressor and makes reference to the risk that: Swallowing or inhaling can be fatal. This advice is only relevant to recycling. There is no danger in normal operation.</p>
	<p>This symbol is located on the compressor and indicates the danger of flammable materials. Do not remove the sticker.</p>
	<p>This or a similar sticker may be located on the rear of the appliance. This sticker indicates that there are vacuum insulation panels (VIP) or perlite panels in the door and/or housing. This advice is only relevant to recycling. Do not remove the sticker.</p>

Description of the appliance

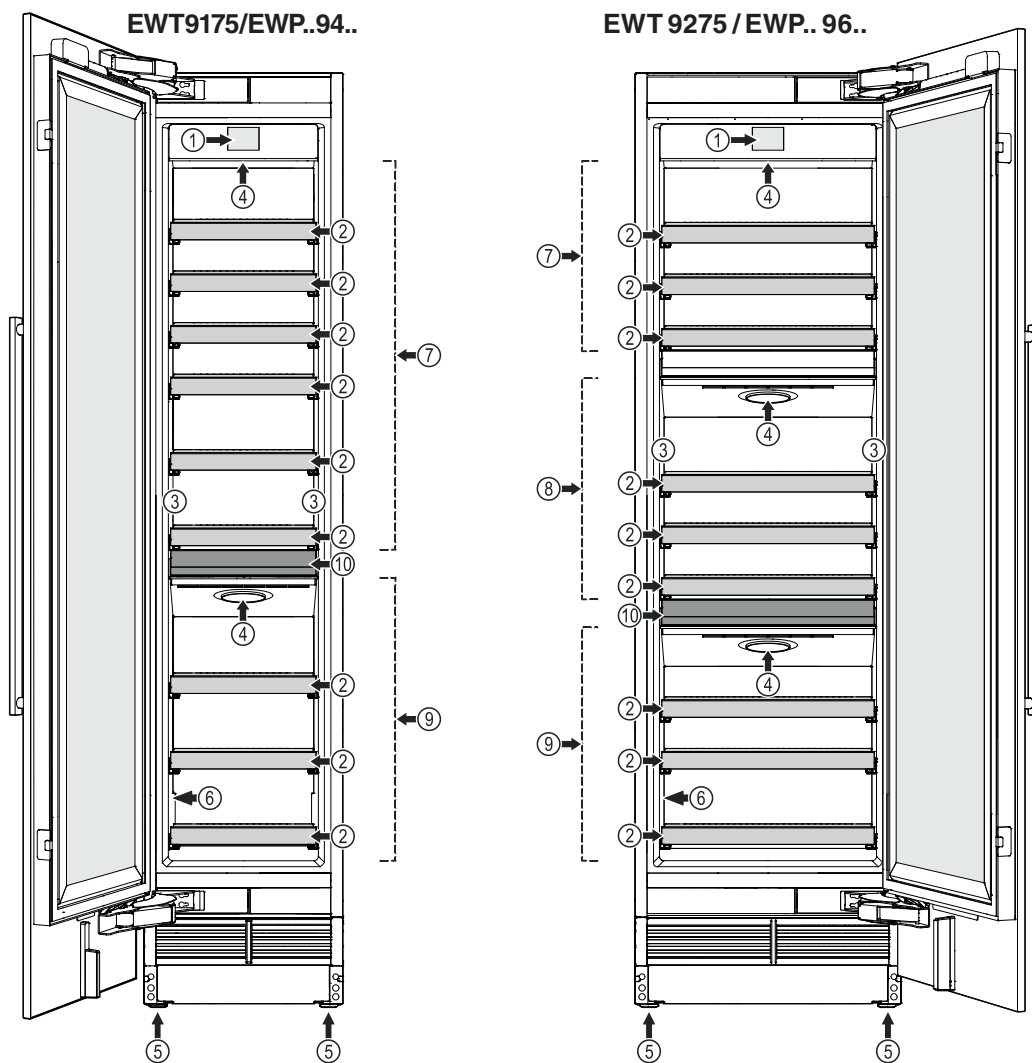

- (1) Control panel
- (2) Pull-out shelf
- (3) Presentation light
- (4) Air filter
- (5) Adjustable-height feet
- (6) Type plate
- (7) Top zone
- (8) Middle zone (EWT 9275 / EWP.. 96.. only)
- (9) Bottom zone
- (10) Serving shelf

Climate rating

The climate rating indicates the room temperature at which the appliance may be operated in order to achieve full refrigeration performance.

The climate rating is indicated on the type plate.

The position of the type plate is shown in the section entitled **Description of the appliance**.

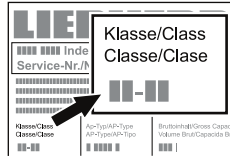

Climate rating	Room temperature
SN	+10°C to +32°C
N	+16°C to +32°C
ST	+16°C to +38°C
T	+16°C to +43°C
SN-ST	+10°C to +38°C
SN-T	+10°C to +43°C

Do not operate the appliance outside the specified room temperature range.

Range of appliance use

The appliance is suitable solely for storing wine in a domestic environment or similar. This includes, for example, use

- in staff kitchenettes, bed and breakfast establishments,
- by guests in cottages, hotels, motels and other forms of accommodation,
- in catering and similar services in the wholesale trade.

Use the appliance solely as is customary within a domestic environment. All other types of use are inadmissible.

The appliance is not suitable for storing and cooling medicines, blood plasma, laboratory preparations or similar substances and products covered by the 2007/47/EC Medical Devices Directive. Any misuse of the appliance may result in damage to or spoilage of stored goods.

Furthermore, the appliance is not suitable for operation in potentially explosive atmospheres.

Disposal notes

The appliance contains reusable materials and should be disposed of properly - not simply with unsorted household refuse. Appliances which are no longer needed must be disposed of in a professional and appropriate way, in accordance with the current local regulations and laws.



When disposing of the appliance, ensure that the refrigerant circuit is not damaged to prevent uncontrolled escape of the refrigerant it contains (data on type plate) and oil.

- Disable the appliance.
- Pull out the mains plug.
- Cut through the connection cable.

WARNING

Danger of suffocation due to packaging material and plastic film!

Do not allow children to play with packaging material.

Take the packaging material to an official collection point.

EPREL database:

As from 1 March 2021, information about energy labelling and ecodesign requirements will be available in the European product database (EPREL). You can access the product database using the following link: <https://eprel.ec.europa.eu/>. You will be asked to enter the model identifier. You will find the model identifier on the type plate.

Lighting	
Class ¹	Light source
This product contains a light source that meets energy efficiency rating G	LED
¹ The appliance may contain light sources with different energy efficiency classes. The lowest energy efficiency class is indicated.	

Control panel

Three different actions to operate the control panel.

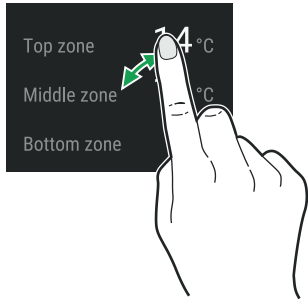

Touch

Touch to activate functions.

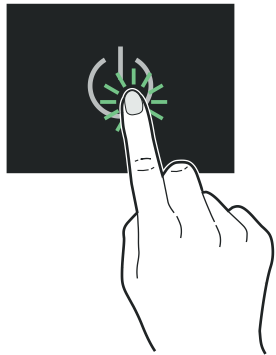

Press

Press for approx. 2 seconds to activate functions.

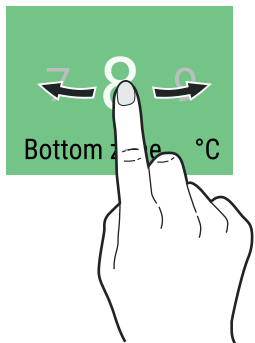

Slide

Slide to right or left to navigate in the menu or to search for values.

Fast access to information

(models EWP.. only)

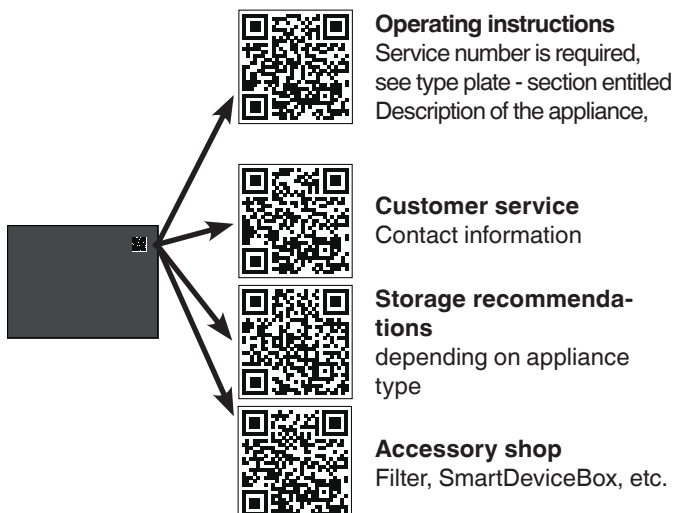

Switching the appliance on

Touch

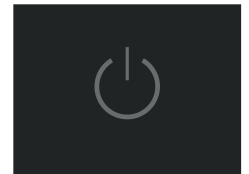

Slide to your language and touch



Available languages:

- German
- Portuguese (Brazil)
- French
- Spanish
- Italian
- English (GB)
- English (US)
- Chinese
- Russian



Slide to the desired temperature unit and touch

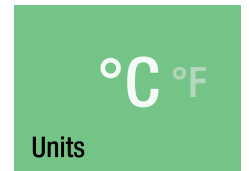

Touch to confirm

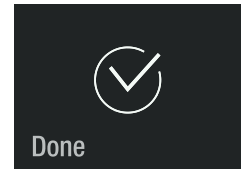

EWT9175/EWP..94..

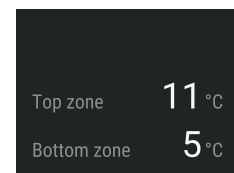

EWT9275/EWP..96..

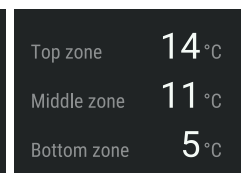







Changing language and temperature unit

For future changes of language and temperature unit, the appliance must be switched off and on again (customer settings will not be deleted).

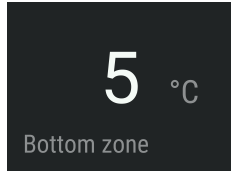
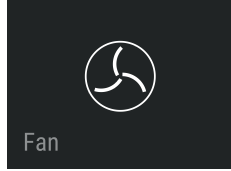
Main menu

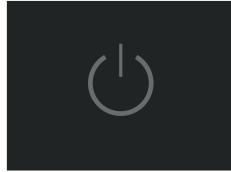
Navigation through the main menu. The following functions are available.

 <p>Top zone</p>	<p>Temperature display for top zone and temperature setting.</p>
 <p>Middle zone</p>	<p>Temperature display for middle zone and temperature setting (EWT 9275 / EWP.. 96.. only).</p>
 <p>Bottom zone</p>	<p>Temperature display for bottom zone and temperature setting.</p>
 <p>Fan</p>	<p>Switching the fan on and off.</p>
 <p>Presentation Light</p>	<p>Adjusting the presentation light brightness.</p>
 <p>SabbathMode</p>	<p>Appliance operating mode for Sabbath and holidays. Complies with STAR-K Kosher Certification.</p>
	<p>Switching the appliance on or off.</p>
 <p>Maintenance</p>	<p>Describes how to replace the filters and clean the dust filter.</p>
 <p>Setup</p>	<p>Allows the adjustment of display brightness and includes the appliance information (service number, model name, serial number).</p>

Setting the temperature

Standard setting is 12°C (all zones). The various zones can be adjusted independently of each other.

Slide to the desired zone. Touch

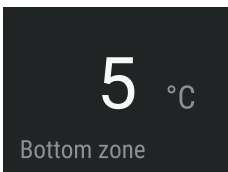

Bottom zone

↓

Slide to the desired target temperature and touch.



Bottom zone °C

↓

The number flashing at the bottom right shows the actual interior temperature. It disappears when the target temperature is reached.



Bottom zone 5 °C

Close the appliance door.

EWT9175/EWP..94..



Top zone 11 °C

Bottom zone 5 °C

Display when the door is opened again.

EWT9275/EWP..96..

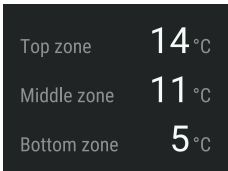

Top zone 14 °C

Middle zone 11 °C

Bottom zone 5 °C

The temperature display will flash if the actual interior temperature differs from the set temperature. It stops flashing when the target temperature is reached.

If you place a large quantity of unchilled wine in the appliance, the set temperature differential may be active for a lengthy period (up to 24 hours) before the set temperature is reached.

The temperature can be set between 5°C and 20°C.

Fan

The interior fan ensures a constant and even interior temperature and a suitable climate for wine storage.

Switching on the fan (all zones) will further increase the humidity in the appliance, which has a particularly positive effect for long-term storage.

The increased level of humidity prevents the corks from drying out.

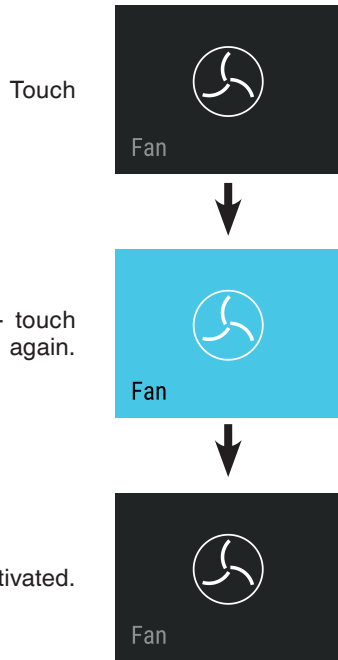

Presentation light

The presentation light is located on the left and right in the refrigerator compartment. The presentation light will be switched on when the door is closed.

Switching on the presentation light

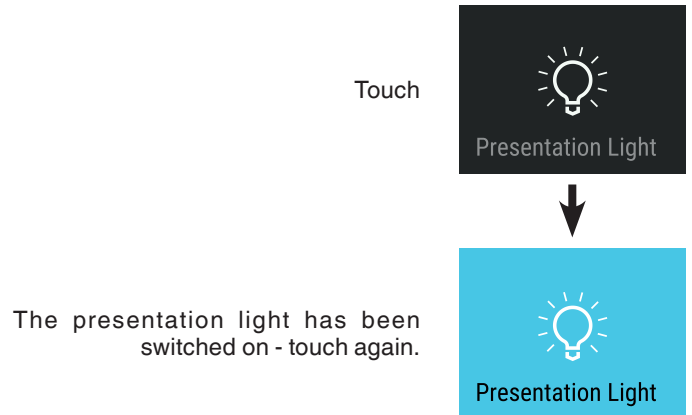

Adjusting the brightness of the presentation light

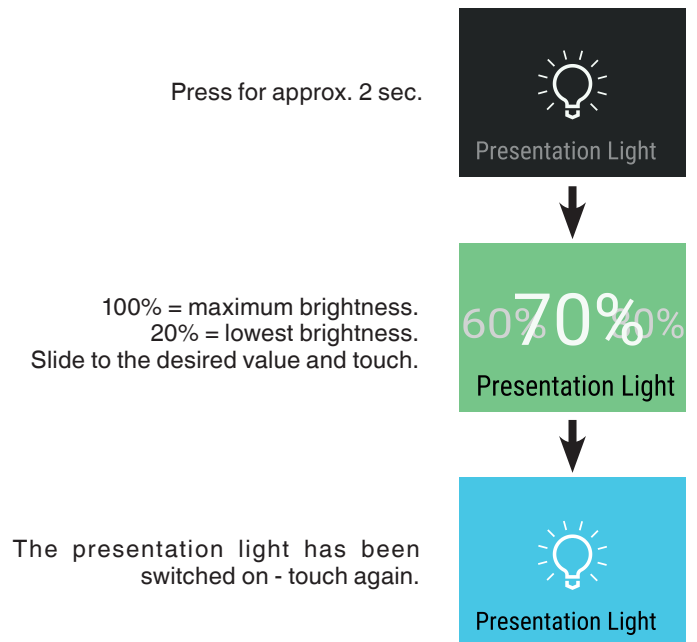

SabbathMode

When SabbathMode is active, some electronic functions are switched off to comply with STAR-K Kosher Certification.

- The lighting remains off.
- There is no door alarm.
- There is no temperature alarm.
- The appliance will return to SabbathMode after a power failure.

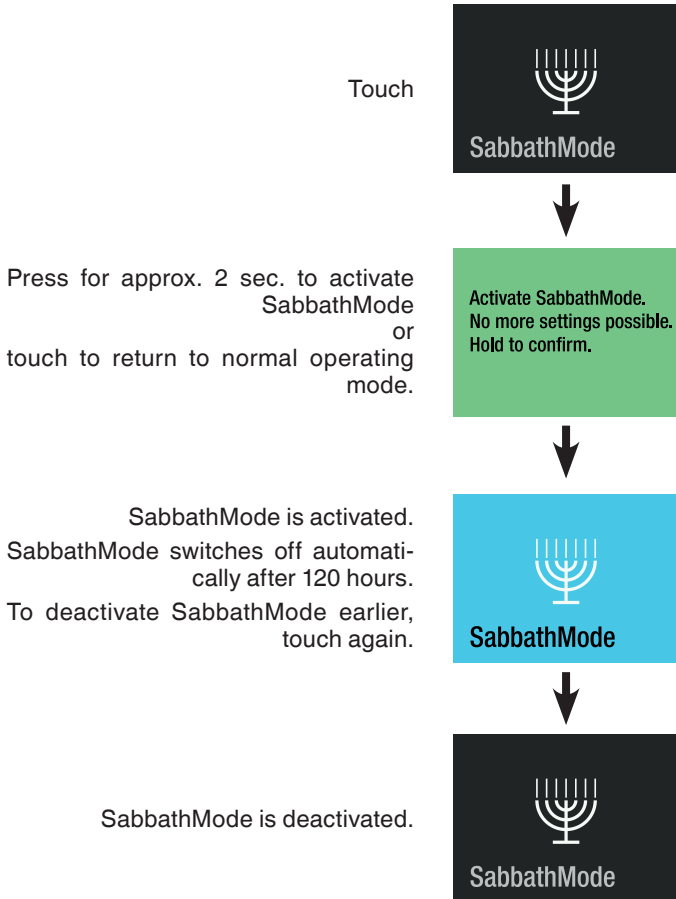

Switching the appliance off

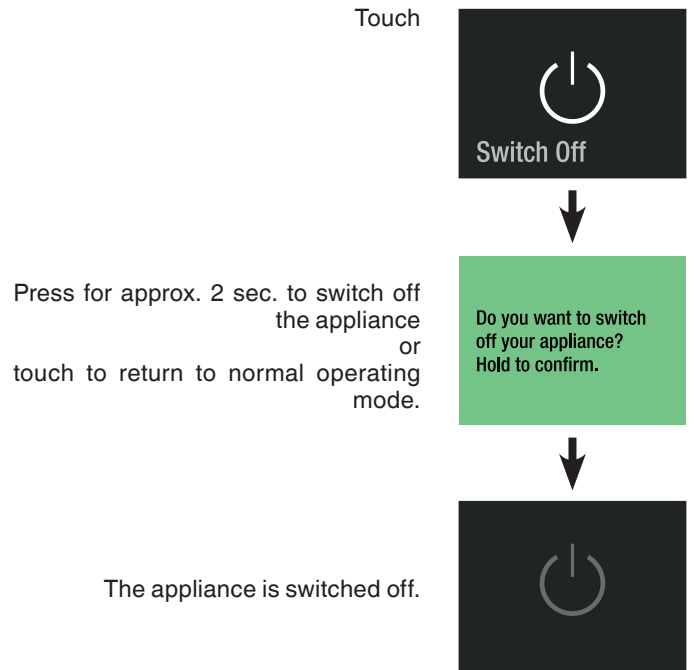

Maintenance message

In regular intervals of operation of the appliance, the maintenance message comes on (6 months). The dust filter needs to be cleaned.

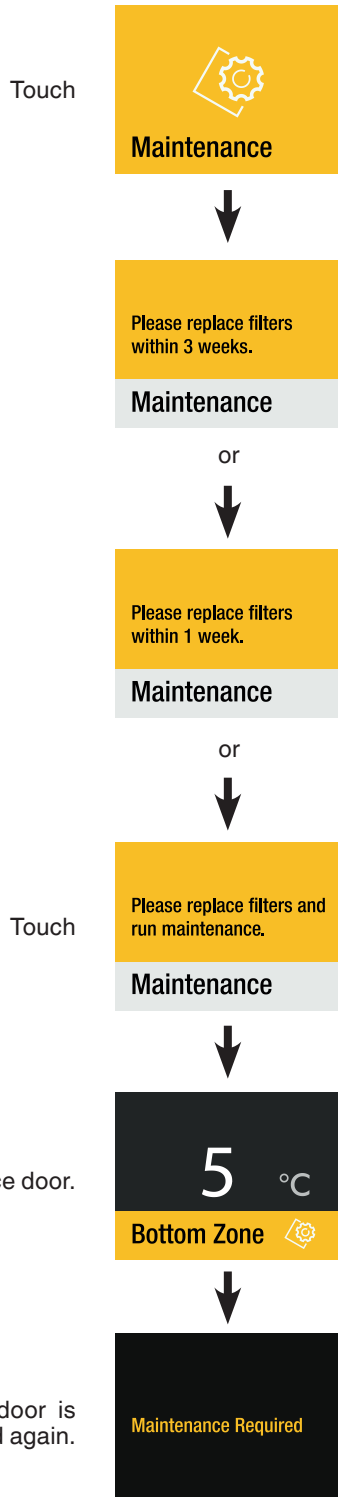

Obtain the air filter from your dealer and complete the maintenance procedure.

Maintenance confirmation

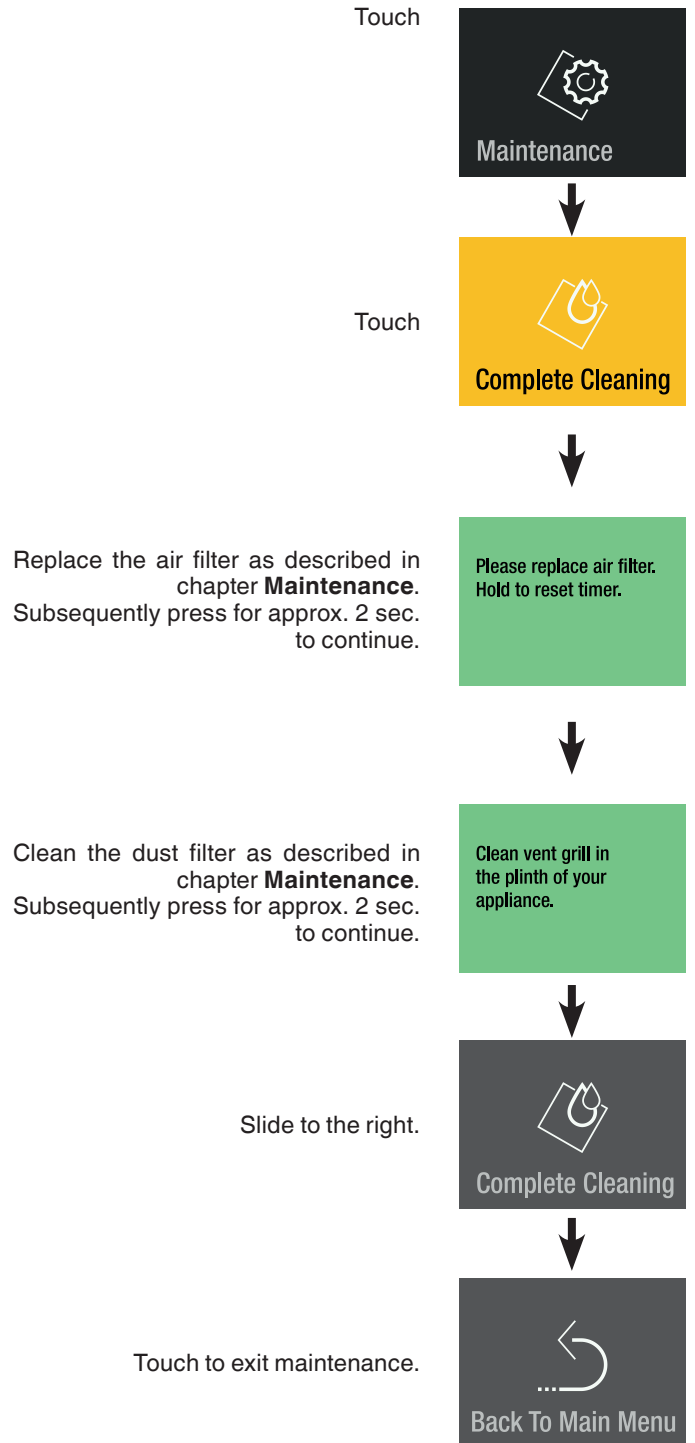

Replace the air filter as described in chapter **Maintenance**. Subsequently press for approx. 2 sec. to continue.

Clean the dust filter as described in chapter **Maintenance**. Subsequently press for approx. 2 sec. to continue.

Setup menu

Includes the adjustment for display brightness, language, units, activation of the SmartDeviceBox and the appliance information.

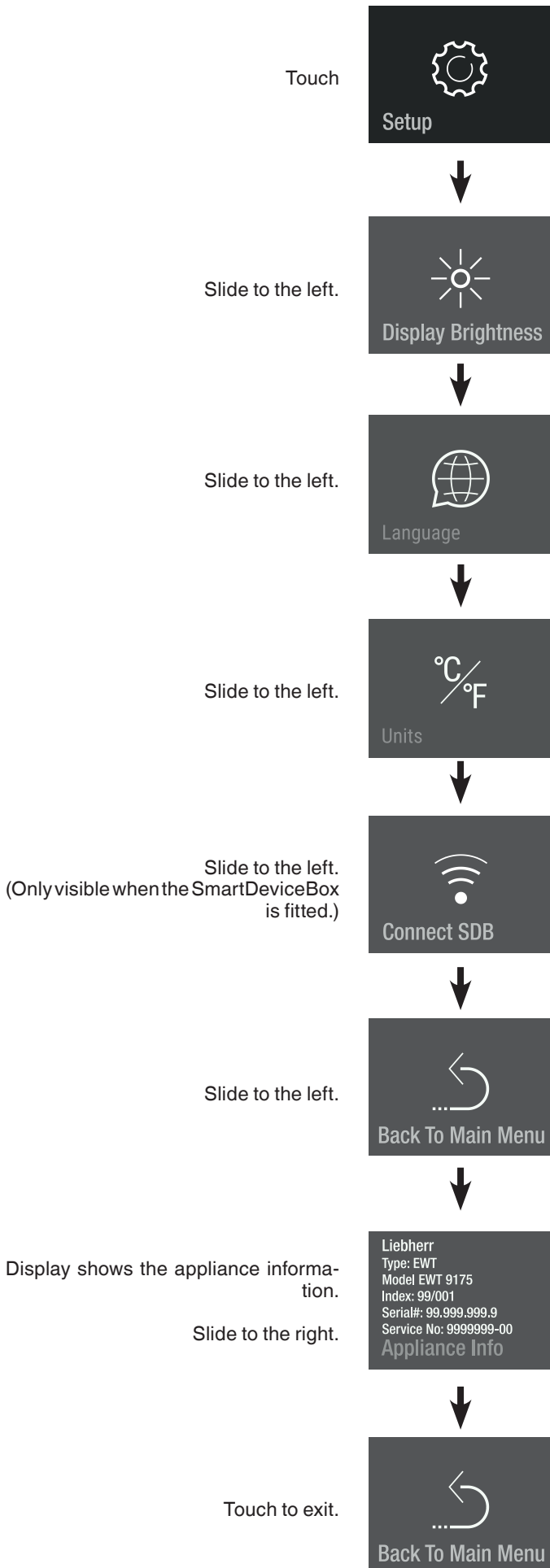

Display brightness



Language

Touch



Slide to your language and touch



Available languages:

- German
- Portuguese (Brazil)
- French
- Spanish
- Italian
- English (GB)
- English (US)
- Chinese
- Russian

Slide twice to the left.

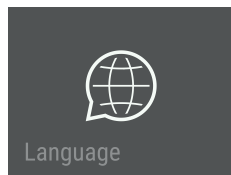

Touch to exit.

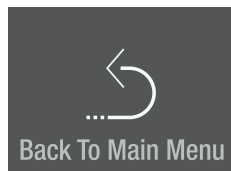

Units

Touch

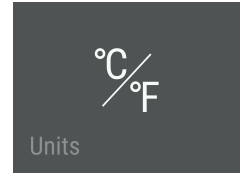

Slide to the desired temperature unit and touch

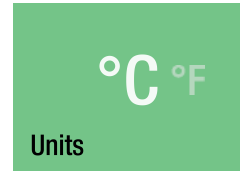

Slide to the left.

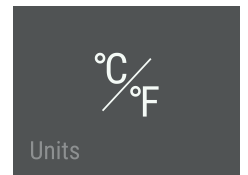

Touch to exit.

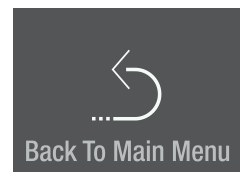

SmartDeviceBox (not supplied in all countries)

The appliance is ready for integration into a smart home system and for extended services.

You will find more information about availability and prerequisites and the individual options on the website smartdevice.liebherr.com.



Download the "SmartDevice" app to your mobile device.

Start the app on your mobile device and follow the instructions.

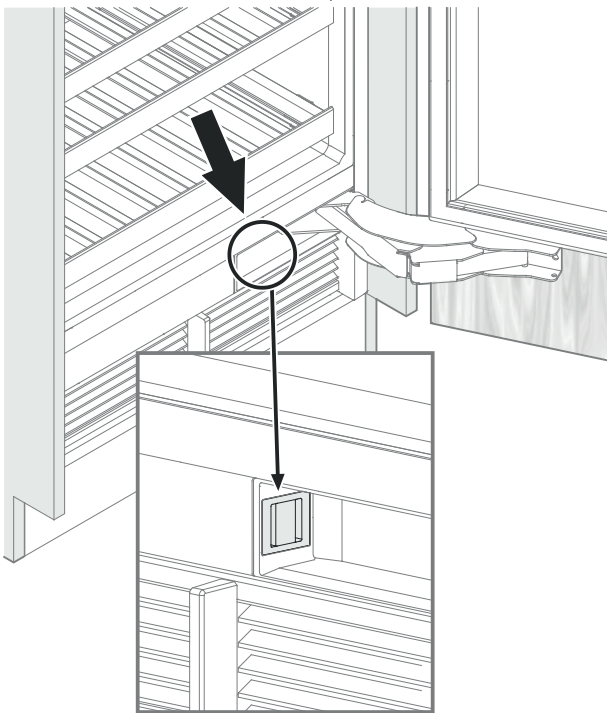

SmartDevice functions are not available in all countries.

Description of the SmartDevice display

SmartDeviceBox is inserted.

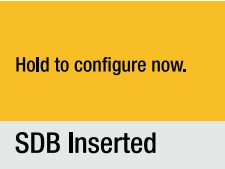

Display to start the WLAN connection.



The symbol flashes.

Connection to WLAN is in progress.



The router credentials are displayed.

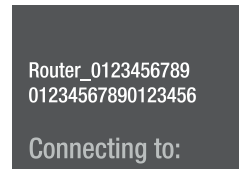

Appliance is connected to WLAN.



Connection reset.

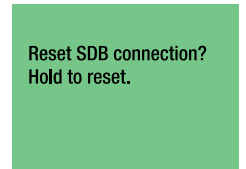

This message informs you of any router or Internet problems.



Alarm messages

Door open alarm

Door has been left open for longer than 60 seconds.

Action
Close the appliance door.



Temperature alarm

Touch



The interior temperature was too high.

Touch
(Touch again if other alarms are active)

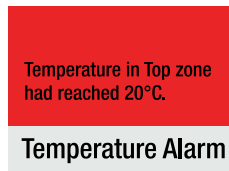

Touch



Action
Check the quality of the stored food.
The alarm display disappears as soon as the set temperature is reached.



Power alarm

Touch



Power supply was interrupted.

Touch



If the interior temperature was too high:

Touch

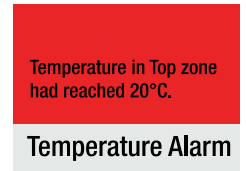

Touch



Action
Check the quality of the stored food.
The alarm display disappears as soon as the set temperature is reached.



Electronic fault alarm

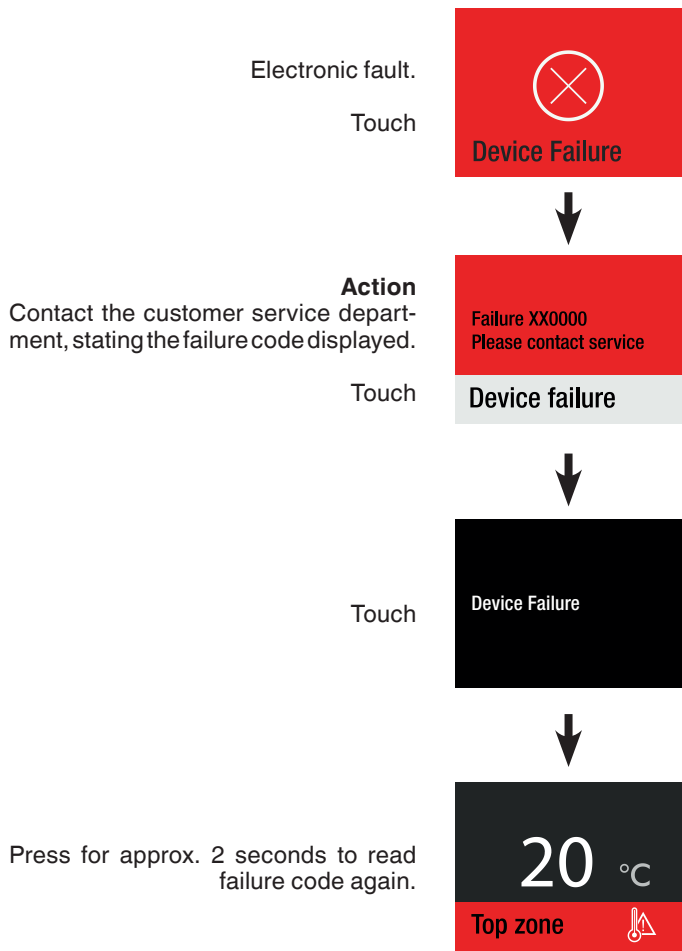

Connection failure

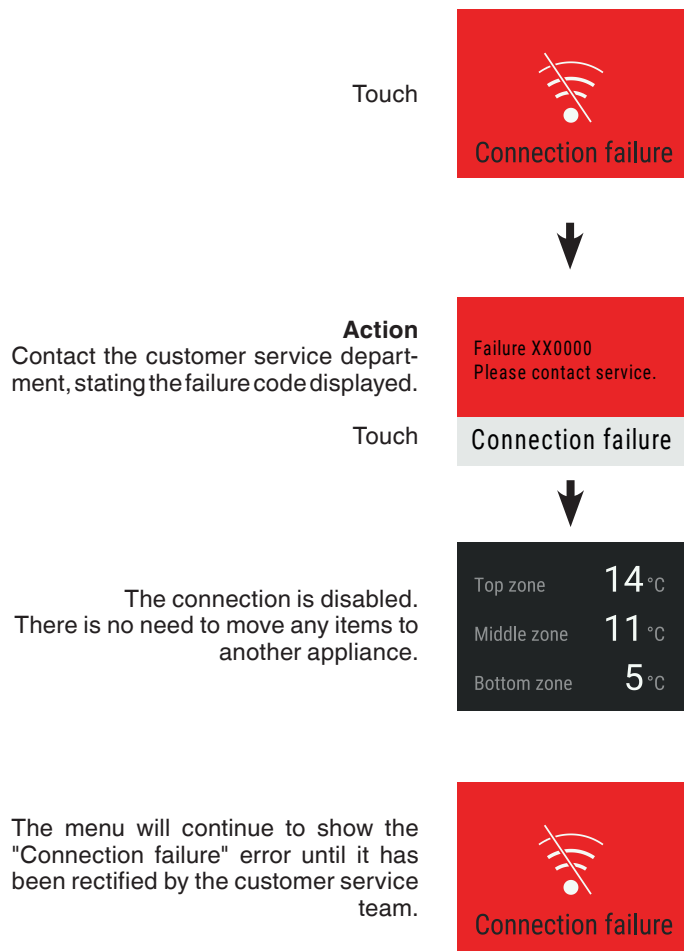

Storage diagram

for 0.75 l Bordeaux bottles to standard NF H 35-124

EWT 9175/EWP..94..

Number of bottles



5
5

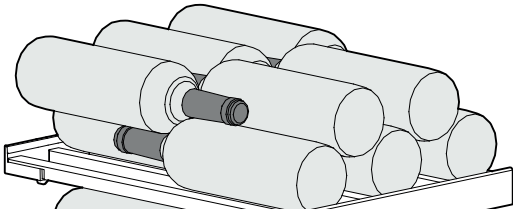

5

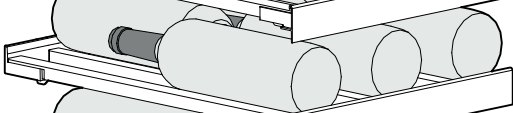

5

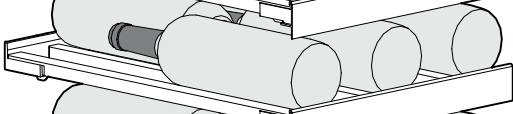

5

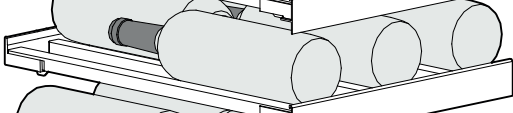

5

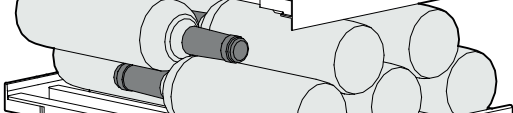

5

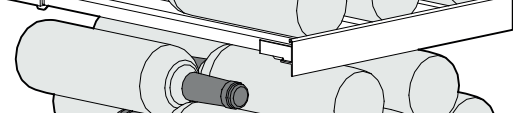

5

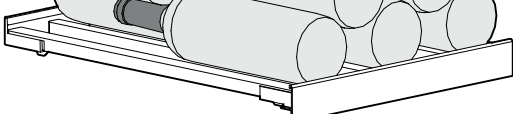

5
5

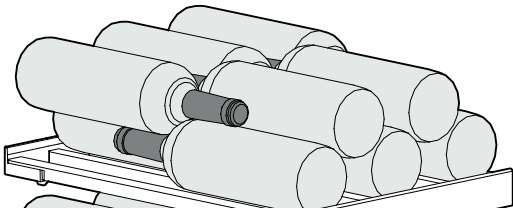

5
5

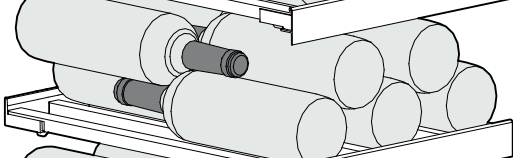

5
5

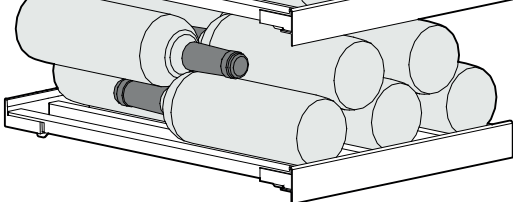

Total: 75 bottles

EWT 9275/EWP..96..

Number of bottles



8
8

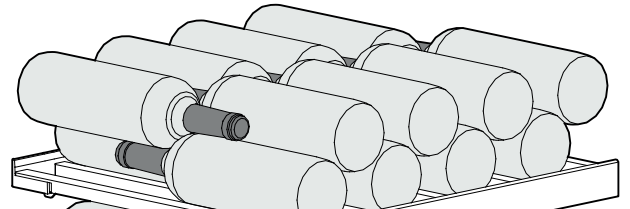

8

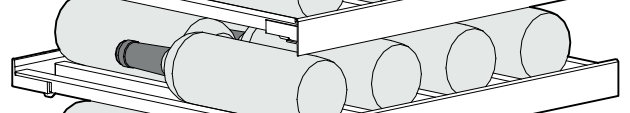

8

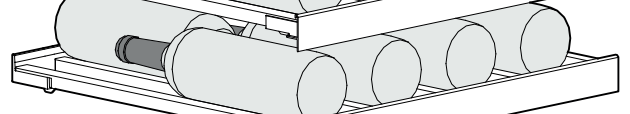

8
8

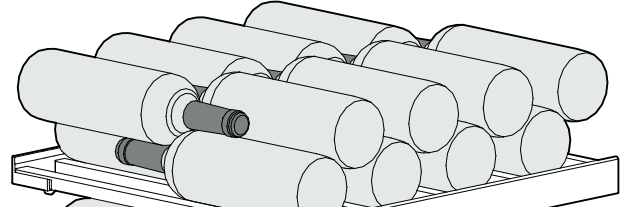

8

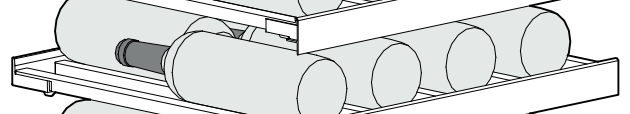

8

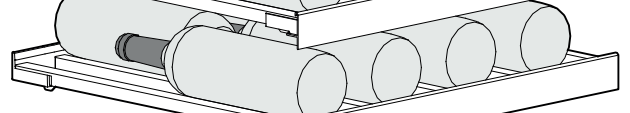

4
8

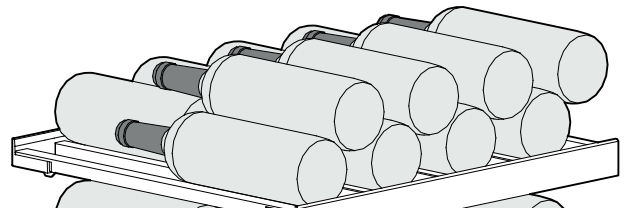

8

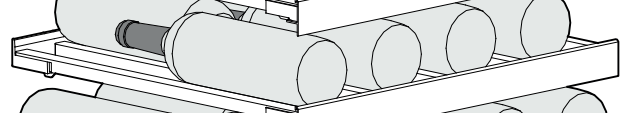

8
8

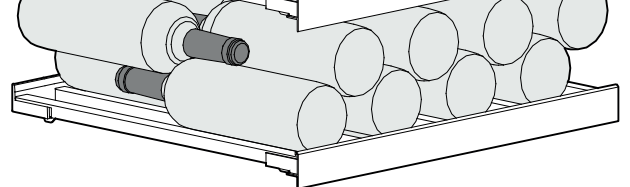

Total: 100 bottles



Notice

The maximum load per wooden shelf is 20 kg.

Equipment

Pull-out shelf

The bars can be removed and repositioned to store larger or smaller bottles.
Raise the bar at the rear (1) and pull it out (2).

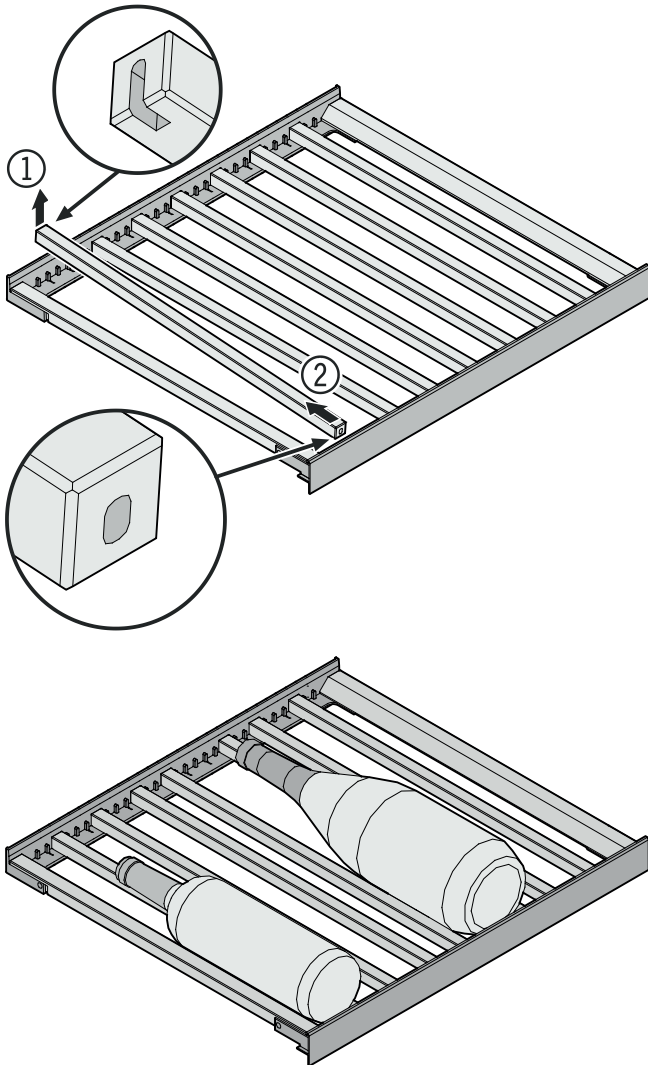

Bar configuration for maximum number of bottles

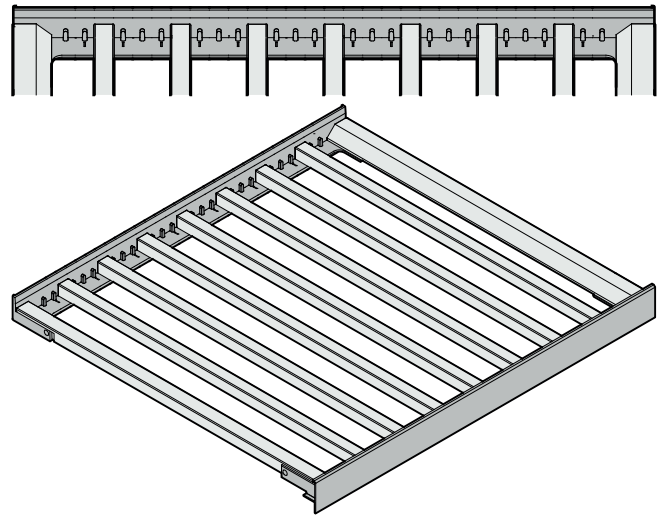

Serving shelf

The serving shelf can be pulled out to provide a surface to hold bottles and glasses.

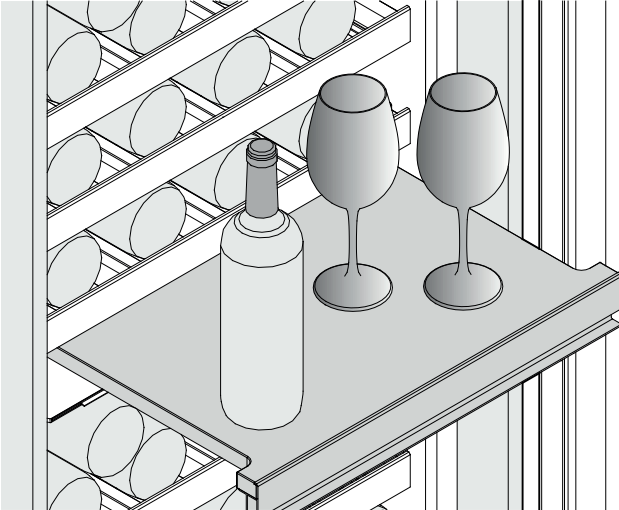

Bottle holder

Insert the supplied bottle holders to house the maximum number of bottles.

Insert the bottle holder between the bars (1), turn it (2) and slide it towards the outside (3).

Then slide the bottle holder to position $X = \sim 80$ mm as shown in the illustration.

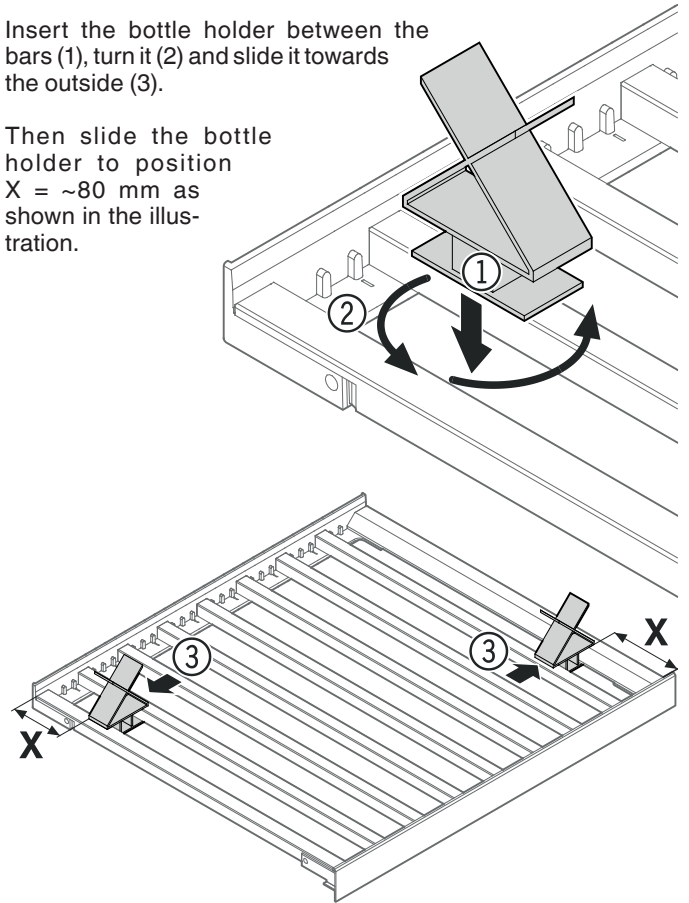

Positioning the bottle holder for the maximum number of bottles:

EWT9175/EWP..94..

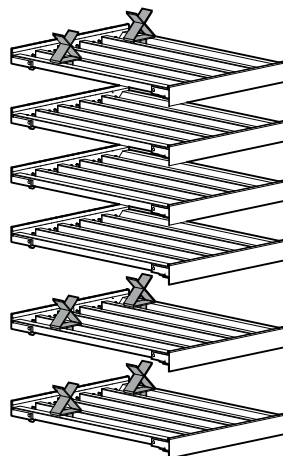

EWT9275/EWP..96..

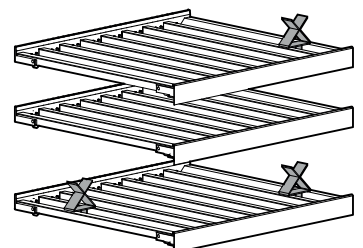
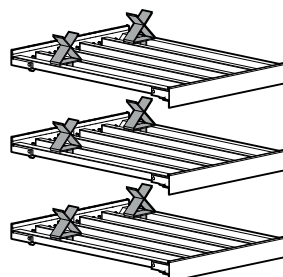
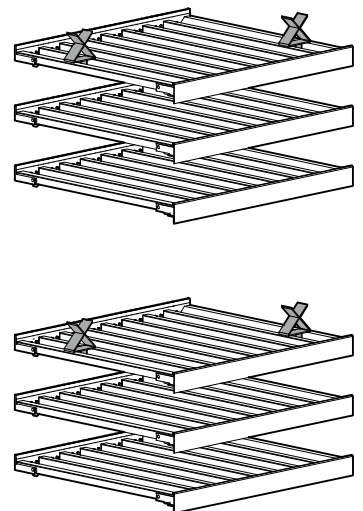

Cleaning

A failure to follow these instructions may result in the food being spoilt.



WARNING!

Before cleaning, always disconnect the appliance from the mains. Pull out the plug or switch off the fuse.

Surfaces which may come into contact with food and accessible drain systems must be cleaned at regular intervals.

If the door is left open for a lengthy period, the temperature in the appliance's compartments may rise dramatically.

- Clean the inside, equipment parts and outer walls with lukewarm water and a little detergent. Do not use chemical solvents or any cleaning agents containing sand or acid.
- Use a glass cleaner to clean the glass surfaces and a commercially available stainless-steel cleaning agent for the stainless-steel surfaces.



CAUTION!

Risk of damage to the appliance components and risk of injury due to hot steam.

Do not use steam cleaning equipment to clean the appliance.

- Ensure that no cleaning water penetrates into the electrical components or ventilation grille.
- Dry all parts well with a cloth.
- Do not damage or remove the type plate on the inside of the appliance. It is very important for servicing purposes.

If the appliance is left empty for a lengthy period, it must be switched off, defrosted, cleaned and dried and the door is to be left open to prevent mould formation.

Removing and inserting the wooden shelves

The wooden shelves can be removed for easier cleaning of the inside of the appliance.

Removing the wooden shelf

Pull out the wooden shelf, press the sides (1) gently, lift it upwards (2) and pull it out towards you (3).

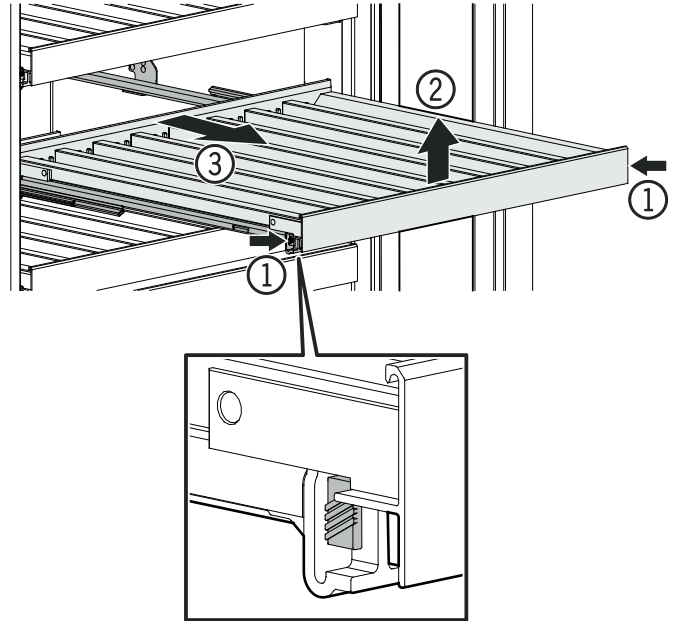

Inserting the wooden shelf

Position the wooden shelf at the rear (1), slide it backwards on the rails (2), attach it at the end (3), and then press it downwards (4) until the shelf engages in the rails (5).

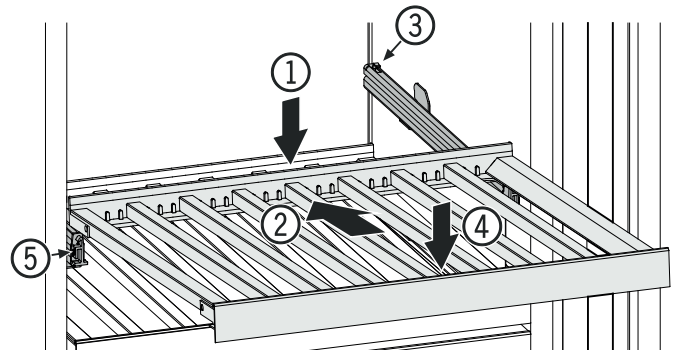

Removing the serving shelf

To remove the serving shelf, first remove the wooden shelf above the serving shelf.

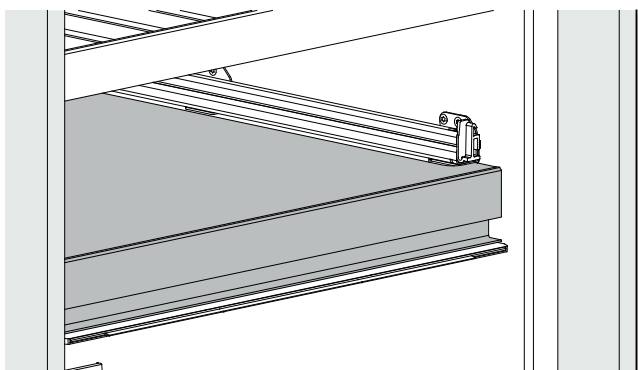

Pull out the serving shelf a little (1), lift the front upwards (2) to release the magnetic connection and pull it out towards you (3).

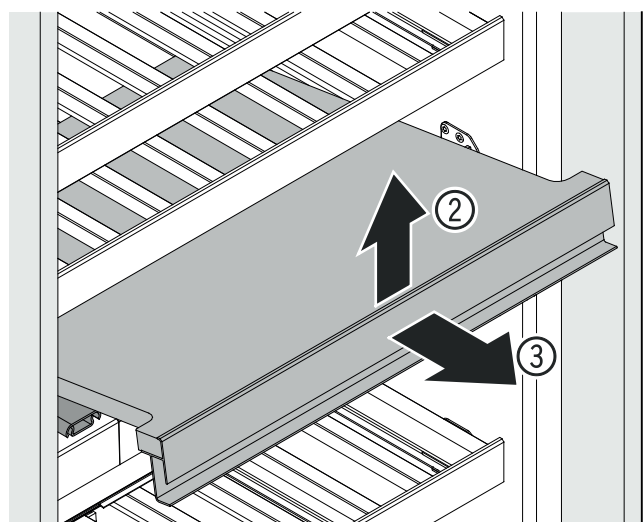
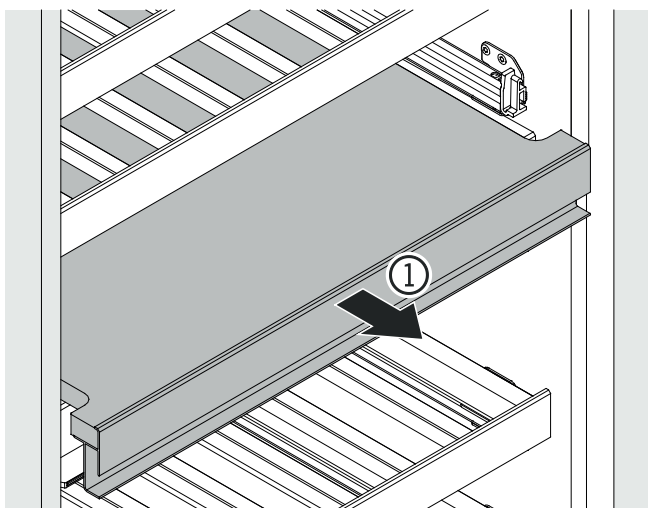

Inserting the serving shelf

Place the serving shelf on the rails. The bolts on the underside of the serving shelf must engage in the rails to be positioned precisely.

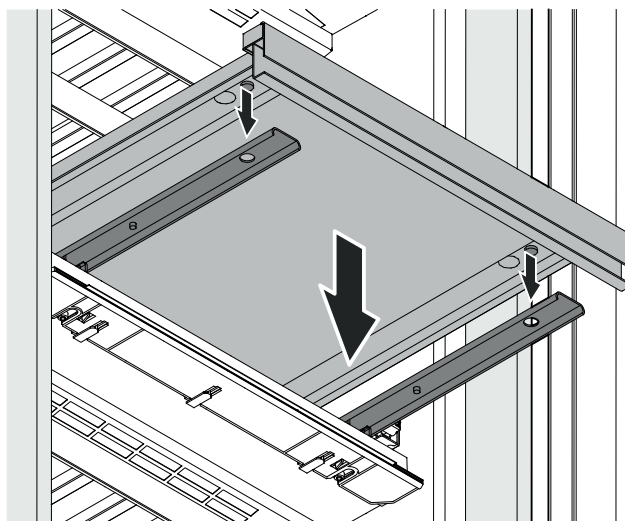

Insert the wooden shelf above the serving shelf.

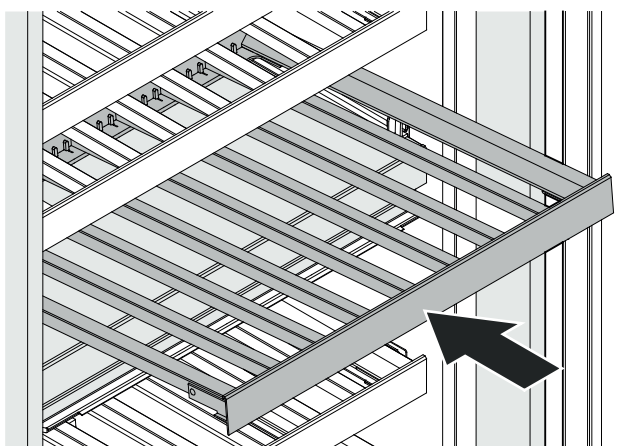

Maintenance menu

Maintenance can be carried out independently of the specified regular intervals. The maintenance menu includes the following steps.

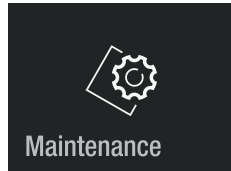

Complete cleaning
For complete maintenance of the appliance.

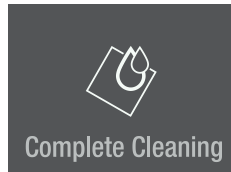

Please replace air filter.
Hold to reset timer.

Clean vent grill in the plinth of your appliance.

New air filter
To reset the maintenance timer.



Please replace air filter.
Hold to reset timer.

To return to the main menu.

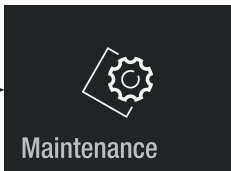
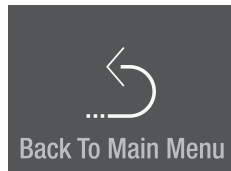

Maintenance

New air filter

The way in which wines continue to mature depends on the ambient conditions.

The quality of the air is therefore decisive for preserving the wine.

It should be changed at least at the indicated maintenance intervals.

Insert the new air filter and turn clockwise until it snaps in.

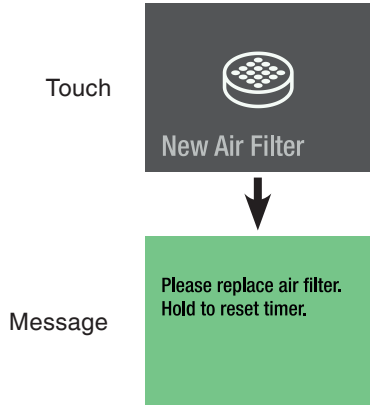
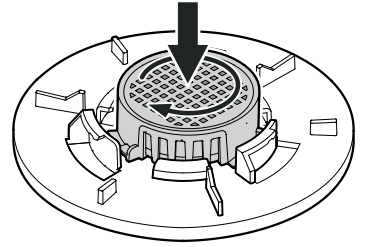

EWT9175/EWP..94..

EWT9275/EWP..96..

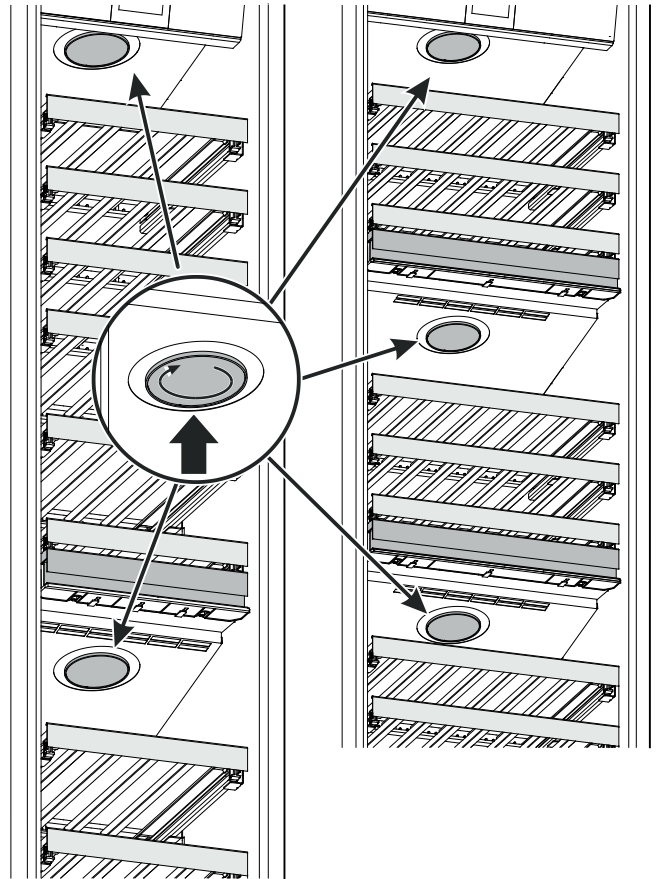

Insert the cover and turn clockwise until it snaps in.

EWT9175/EWP..94..

EWT9275/EWP..96..

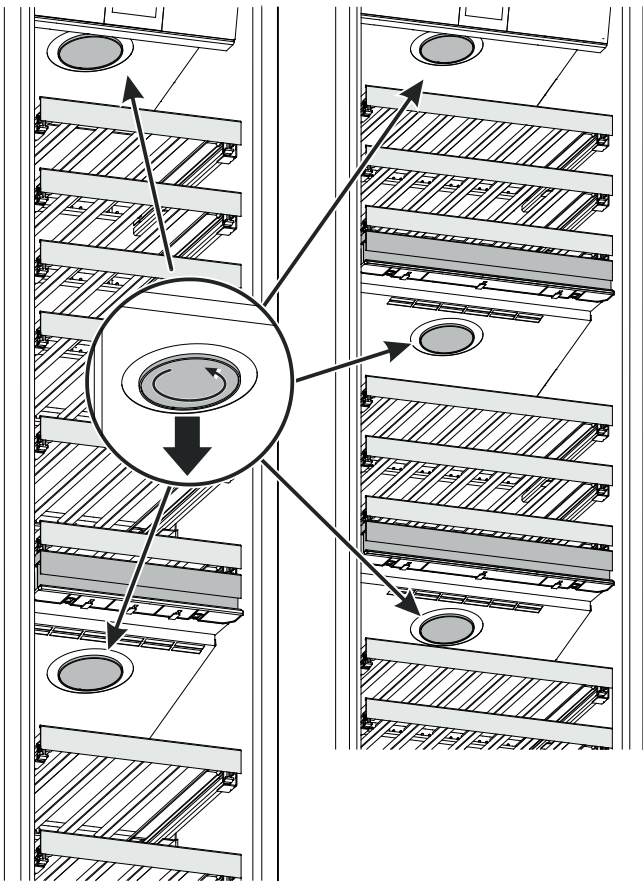

Turn the cover anticlockwise and remove it.

Turn the air filter anticlockwise and remove it.

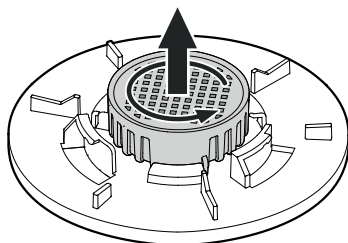

Press for approx. 2 sec.
The maintenance timer for air filter change is reset.



Slide twice to the left.



Touch to exit the menu.

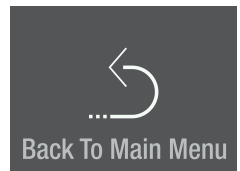

Cleaning the dust filter

Clean the dust filter in the plinth area at least at the indicated maintenance intervals.

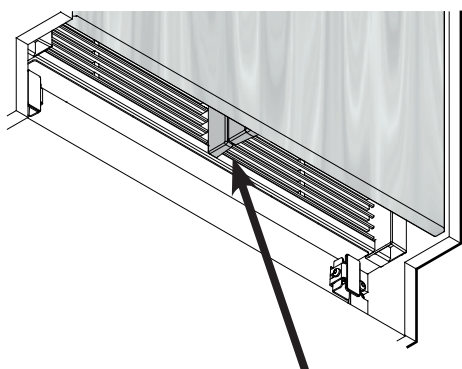
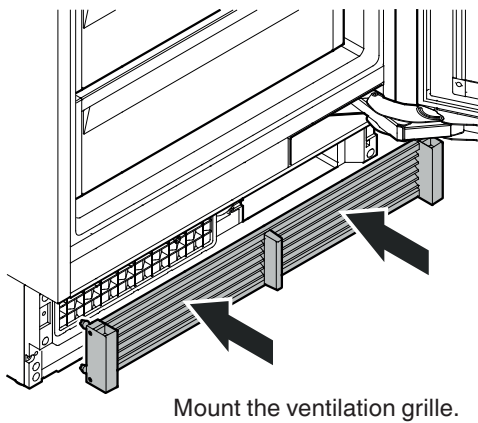
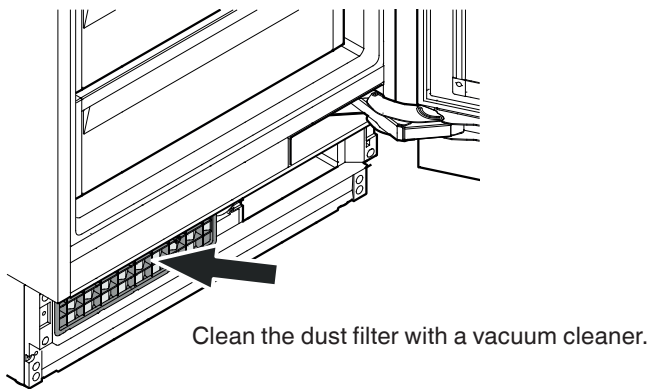
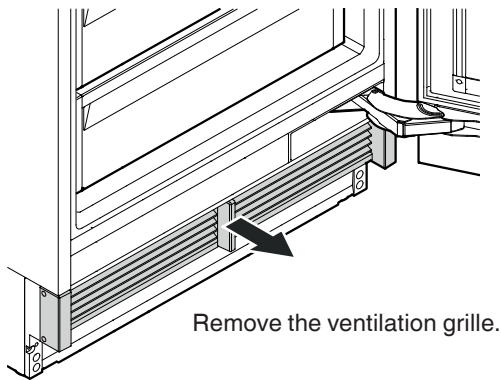

IMPORTANT

There will be a gap if the ventilation grille is fitted incorrectly.

Additional functions

Activating the defrost function manually
Reset to factory settings
DemoMode

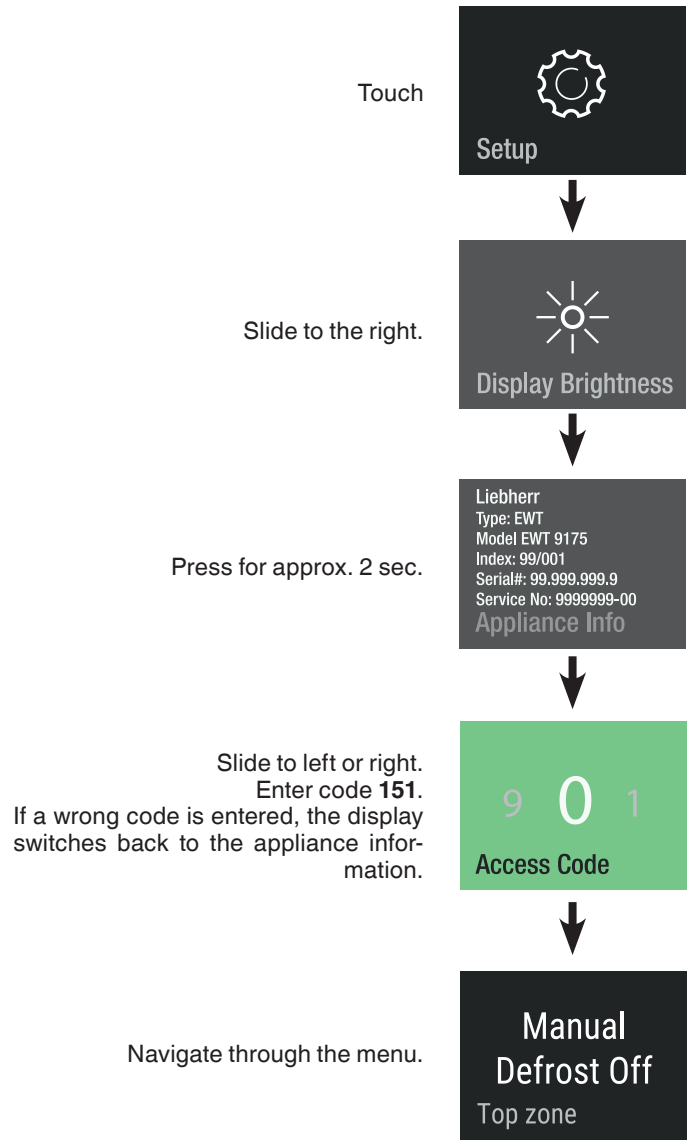

Manual defrost

The appliance defrosts automatically. The defrost function can be activated manually for service applications.

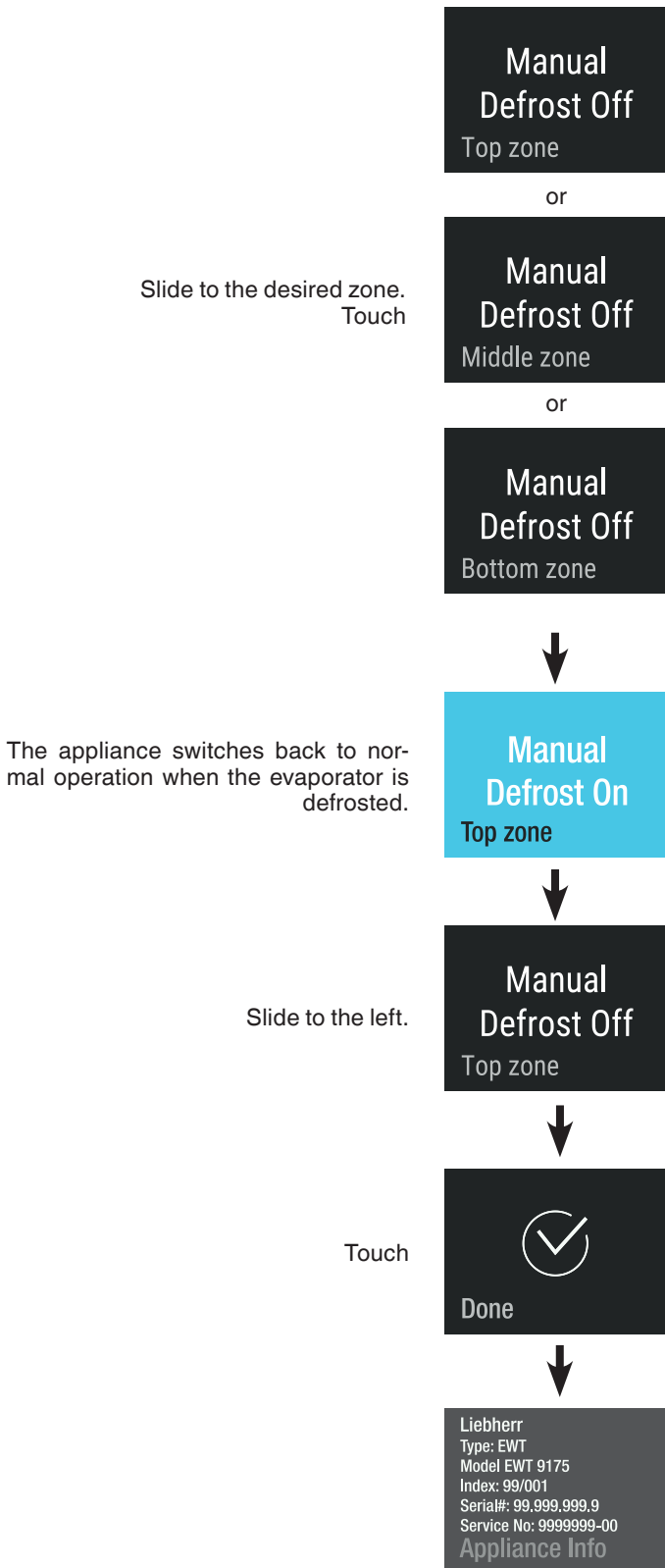

Reset

The electronic control system can be reset to factory settings using this function.

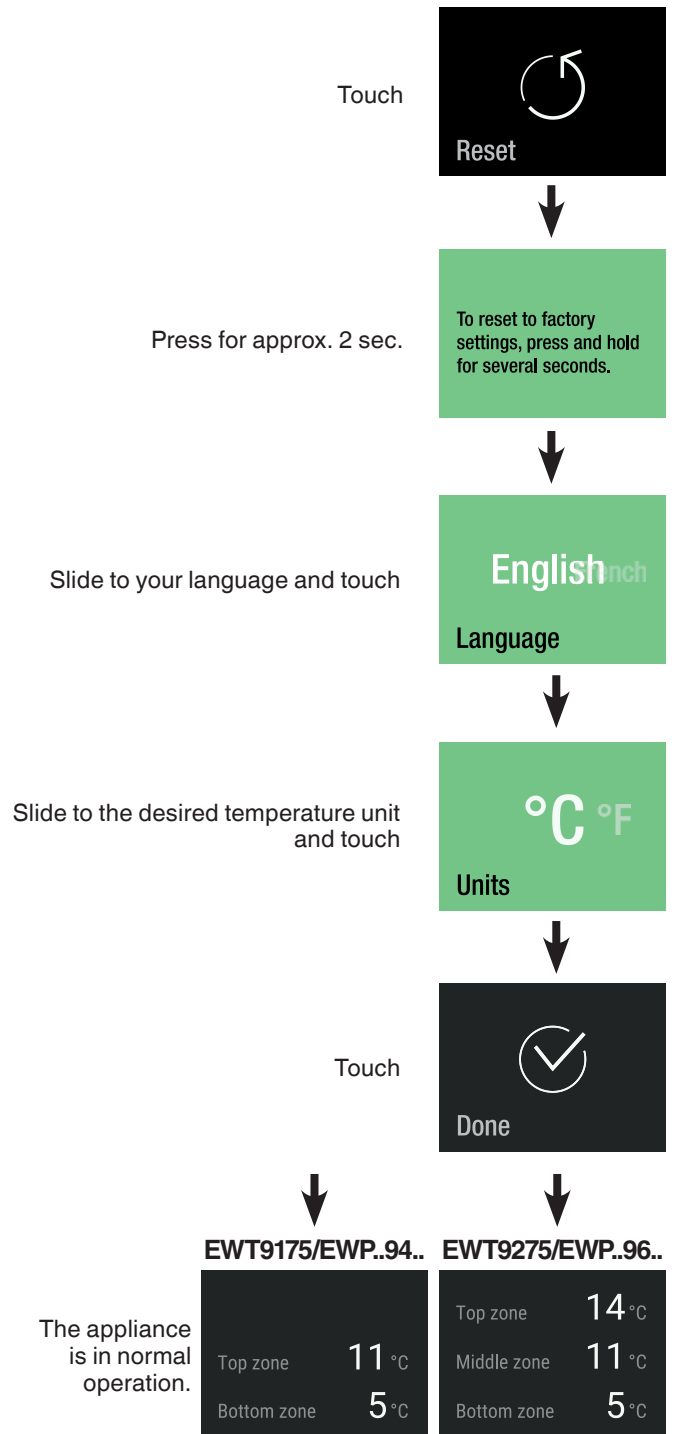

DemoMode

DemoMode can be activated for presenting the appliance at exhibitions or in salesrooms as if it were in normal operating mode.

Activating DemoMode

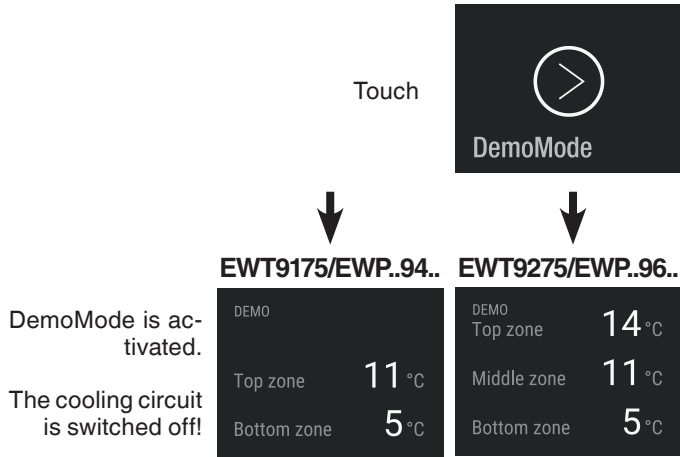

Deactivating DemoMode

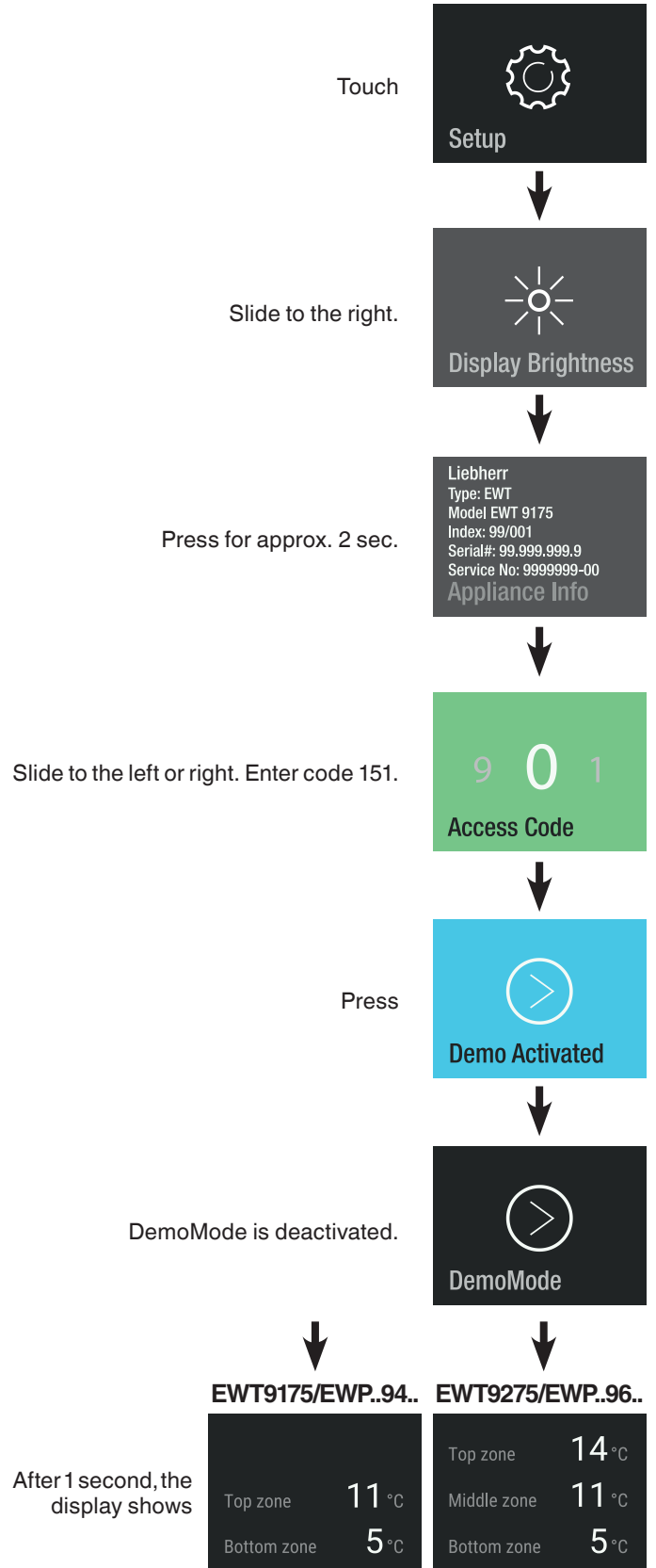

Malfunctions

You may be able to rectify the following faults by checking the possible causes yourself.

Appliance does not function:

- Is the appliance switched on?
- Is the plug correctly fitted in the mains socket?
- Is the fuse intact?

Loud running noise:

- Is the appliance set up firmly on the floor?
- Does the appliance cause nearby items of furniture or objects to vibrate? Please note that noises caused by the refrigerant circuit cannot be avoided.

The temperature is not low enough:

- Is the temperature setting correct (see "Setting the temperature")?
- Does the separately installed thermometer show the correct reading?
- Is the ventilation system working properly?
- Is the appliance set up too close to a heat source?

If none of the above causes apply and you cannot rectify the fault yourself, contact the nearest customer service department stating the type designation (1), service number (2) and appliance number (3) as indicated on the type plate.

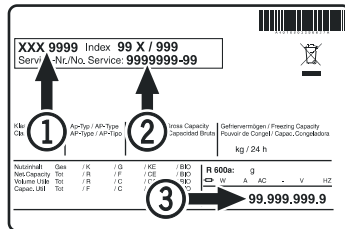

The position of the type plate is shown in the section entitled **Description of the appliance**.

Shutting your appliance down

If your appliance is to be shut down for any length of time, switch it off and disconnect the plug or switch off or unscrew the fuse.

Clean the appliance and leave the door open in order to prevent unpleasant smells.

The appliance complies with the relevant safety regulations and EU Directives 2014/35/EU, 2014/30/EU, 2009/125/EC and 2011/65/EU.



Liebherr Hausgeräte Lienz GmbH
Dr.-Hans-Liebherr-Strasse 1
A-9900 Lienz
Österreich
www.liebherr.com

