

SBSes 8474

Side-by-Side combination
Premium

LIEBHERR

Freestanding



SBNes 4265

Fridge-freezer with BioFresh and NoFrost Premium



← 60 →



Energy consump. in 365 days/24 h	204 kWh¹
Total net capacity	298 l
Total net	Fridge: 172 l including BioFresh compartment: 172 l / Freezer compartment: 126 l
Frequency / voltage	50/60 Hz / 220-240 V~
Connection Rating	1.4 A 231 W
Door / Side walls	SmartSteel / SmartSteel
Exterior dimensions in cm (h / w / d)	185 / 60 / 66.5¹
Controls	
Type of Control	2.4" TFT-colour display behind-the-door, touch electronic Digital temperature display for BioFresh and freezer compartments
Interface	SmartDeviceBox: optional accessory (Only available in selected countries)
Door alarm	visual and acoustic
Alarm in case of malfunction	visual and acoustic
Fridge compartment	
Forced air system	PowerCooling with FreshAir activated charcoal filter
Interior light	LED ceiling lighting with dimmer function LED BioFresh lighting
BioFresh-Safes	2 BioFresh-Safes on telescopic rails, of which 1 variably adjustable from Fruit & Vegetable-Safe to DrySafe
Freezer compartment	
Star coding	****
Interior light	LED lighting
Number of drawers	5 drawers, of which 2 set on roller tracks, VarioSpace
IceMaker	with fixed 3/4" water connection
Ice cube capacity in 24 hours	- kg
Ice cube stock	1.8 kg
Cold storage accumulators	2
Features	
Side-by-Side concept	Side wall heating right, suitable for combination with other refrigerators, freezers and/or wine appliances
Door hinges	Reversible door hinge, left
EAN-Nr.	4016803050636

¹ To achieve the indicated energy consumption level, the wall spacers provided with the appliance must be used. These increase the appliance depth by approximately 1.5 cm. If the wall spacers are not used, the appliance will remain fully functional, but will have a slightly higher energy consumption level.

Features

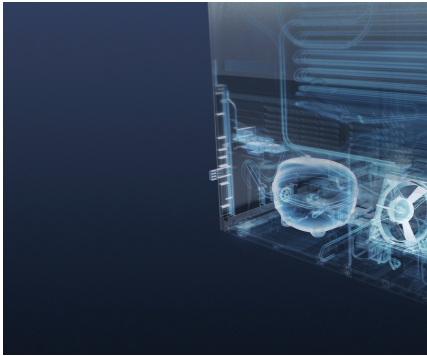

BluPerformance

Offering even more interior capacity for food storage, economy and energy efficiency, quiet operation, ease-of-use and exceptional design: Liebherr's BluPerformance appliances set both a new direction in refrigeration and freezing, and new benchmarks.



BioFresh

In the BioFresh compartments food retains its healthy vitamins, aroma and appetising appearance significantly longer than in a conventional fridge. Through its advanced technology the temperature is accurately kept at just above 0 °C.



NoFrost

The NoFrost system from Liebherr provides rapid, fan-assisted, frost-free freezing for the safe, longterm storage of food. The NoFrost technology creates a much larger storage capacity and keeps the freezer constantly frost-free.



IceMaker with fixed water connection

The plumbed-in IceMaker automatically keeps you topped up with the finest quality ice cubes so that you are prepared for every occasion.

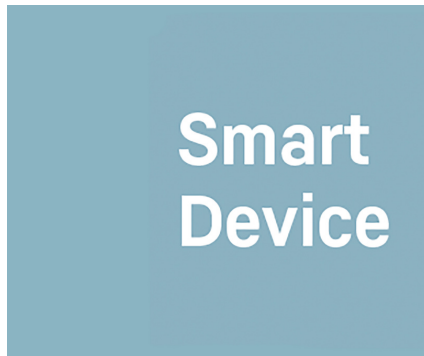

SmartDevice

On Liebherr appliances bearing the "SmartDevice" logo, the SmartDeviceBox allows the appliance to be controlled and used via mobile devices. The SmartDeviceBox can be ordered as an accessory. Some appliances come with the SmartDeviceBox already integrated. This is indicated by the "i" in the appliance designation - for example "Kbi 4350".



DuoCooling

DuoCooling uses two completely separate refrigeration circuits to ensure no air is exchanged between the fridge and freezer compartments. The food neither dries out nor is odour transferred. This means throwing less away, shopping less often, but saving more and greater enjoyment.

SKBes 4350

Refrigerator with BioFresh
Premium



← 60 →



Energy consump. in 365 days/24 h	194 kWh¹
Total net capacity	367 l
Total net	Fridge: 367 l including BioFresh compartment: 133 l
Frequency / voltage	50/60 Hz / 220-240 V-
Connection Rating	1.2 A
Door / Side walls	SmartSteel / SmartSteel
Exterior dimensions in cm (h / w / d)	185 / 60 / 66.5¹
Controls	
Type of Control	2.4" TFT-colour display behind-the-door, touch electronic Digital temperature display for fridge and BioFresh compartments
Interface	SmartDeviceBox: optional accessory (Only available in selected countries)
Door alarm	visual and acoustic
Alarm in case of malfunction	visual and acoustic
Fridge compartment	
Forced air system	PowerCooling with FreshAir activated charcoal filter
Door interior	Premium GlassLine storage shelf with bottle holder, VarioBoxes, adjustable egg tray, butter dish
VarioSafe	yes
Bottle shelf	Variable bottle shelf
Interior light	LED ceiling lighting with dimmer function LED BioFresh lighting LED rear wall lighting
BioFresh-Safes	3 BioFresh-Safes with SoftTelescopic, of which 2 variably adjustable from Fruit & Vegetable-Safe to DrySafe
Features	
Side-by-Side concept	Side wall heating left, suitable for combination with other refrigerators, freezers and/or wine appliances
Door hinges	Reversible door hinging
EAN-Nr.	4016803051497

¹ To achieve the indicated energy consumption level, the wall spacers provided with the appliance must be used. These increase the appliance depth by approximately 1.5 cm. If the wall spacers are not used, the appliance will remain fully functional, but will have a slightly higher energy consumption level.

Features

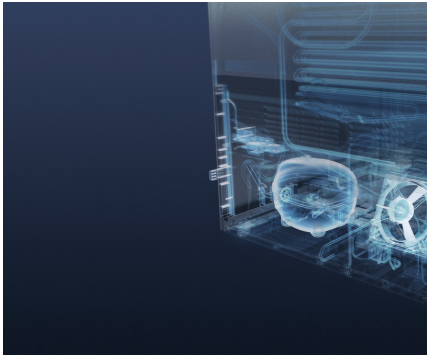

BluPerformance

Offering even more interior capacity for food storage, economy and energy efficiency, quiet operation, ease-of-use and exceptional design: Liebherr's BluPerformance appliances set both a new direction in refrigeration and freezing, and new benchmarks.



BioFresh

In the BioFresh compartments food retains its healthy vitamins, aroma and appetising appearance significantly longer than in a conventional fridge. Through its advanced technology the temperature is accurately kept at just above 0 °C.

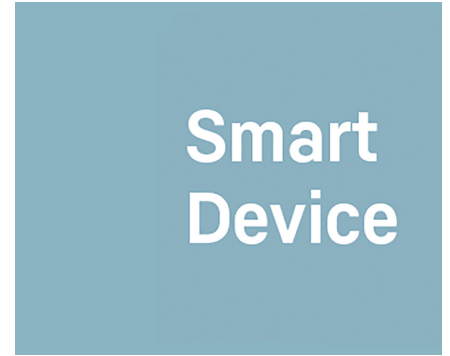

SmartDevice

On Liebherr appliances bearing the "SmartDevice" logo, the SmartDeviceBox allows the appliance to be controlled and used via mobile devices. The SmartDeviceBox can be ordered as an accessory. Some appliances come with the SmartDeviceBox already integrated. This is indicated by the "i" in the appliance designation - for example "Kbi 4350".



Versatile bottle shelf

The versatile bottle shelf is an innovative feature in all BioFresh Premium models. It can be positioned above or below the glass shelf to suite individual requirements.

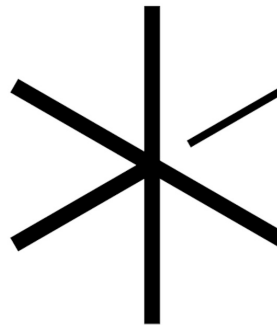

SuperCool

SuperCool generates greater cold reserves so that freshly stored food can be rapidly chilled. Reversion from the chilling temperature of +2 °C to the normal refrigeration temperature is time or quantity-controlled to help save energy.



Softsystem

The integrated SoftSystem mechanism cushions door closure even when the door shelves are fully stocked; it ensures gentle closing and prevents bottles, jars and packets or food from falling out of the door.

Technical drawing

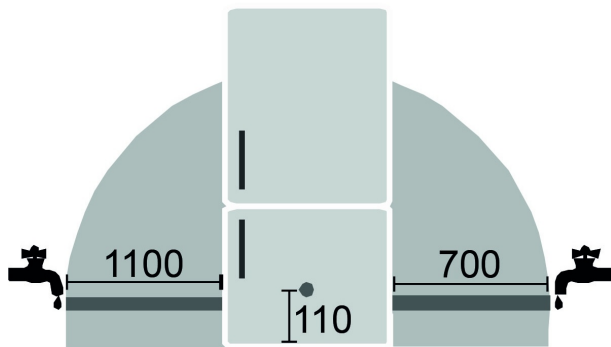
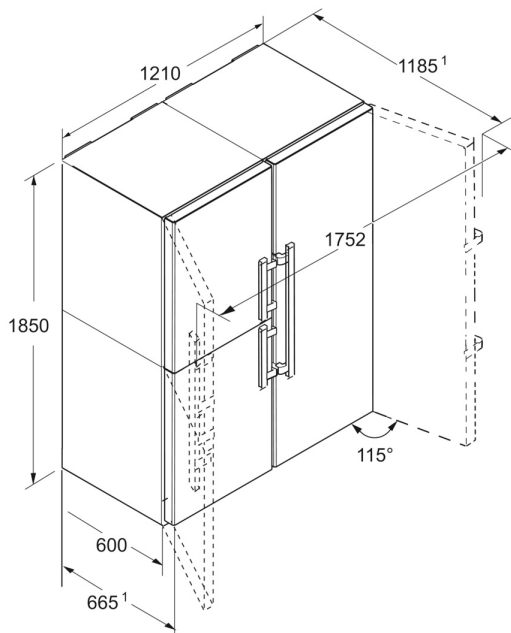

SBNes 4265

Products and their details are staged for advertising purposes. Whilst every effort is made to ensure all specifications and information in this flyer are accurate, Liebherr reserves the right to make changes without notification. Where actual appliance measurements, specifications, and ratings are crucial, we recommend that the actual appliance installation instructions that accompany each appliance be checked. Liebherr will not be liable for any damage. (03.04.2023)

